

Jan 19.26

Tower



REG. U.S. PAT. OFF.

New Diaphragm— —A Distinctively Exclusive Feature

WE will pay \$500 cash for a name best describing the new Tower Diaphragm—the most important discovery in over 50 years of experimental work in the acoustical field. Over 1000 other valuable prizes will be awarded to persons submitting names of merit

Over fifty years ago Alexander Graham Bell invented the telephone receiver with its all-metal Diaphragm. Until now the world's greatest acoustical experts have been unable to effect any radical improvements on this type.

Now—after exhaustive experiments, Dr. Herman Fisher, the eminent Russian scientist and acoustical expert of the Tower Co., has perfected a marvelous new Diaphragm—revolutionary in principle and unparalleled in performance.

The Diaphragm consists of two different materials, one of which reproduces the upper register of the scale, and the other, the lower, making it a veritable double diaphragm which brings out ALL the notes with an amazing mellowness of tone, increased volume and COMPLETE absence of distortion, hitherto never attained in a radio loud speaker.

The name "High-Low Tone" has been suggested but we believe some one can suggest a better one. Let us have yours—it may win the \$500 prize or one of the 1000 additional awards.

Names must be submitted on U S postcards with name and address of sender clearly printed—no others considered. Send as many names as you wish. Contest closes February 15th, so act promptly. Decision of Tower Company officials will be final. In event winning name is suggested by more than one person, prizes will be divided equally

Tower Mfg. Corp., Boston, Mass.

Only Tower Speakers equipped
with this New Diaphragm



Scientific \$8.50



Midget \$3.95



Meistersinger Cabinet Model \$15.00

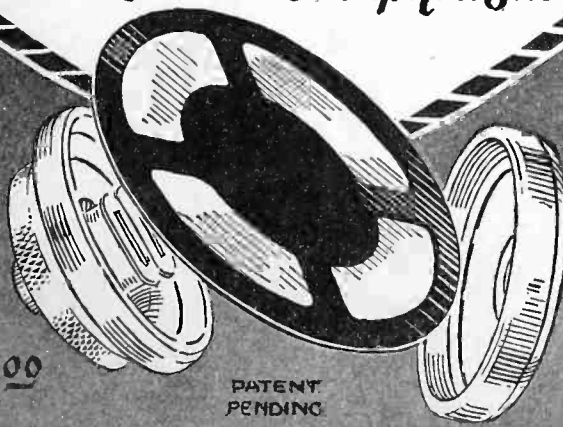

PATENT PENDING



Little Spitfire \$4.95



Meistersinger \$15.00



Tower Scientific \$2.95



Phonograph Attachment \$3.95

WORLD'S GREATEST SPEAKER VALUES

Tell them that you saw it in RADIO

RADIO

With Which is Incorporated "Radio Journal"
Established 1917

Published Monthly by the Pacific Radio Publishing Co.

ARTHUR H. HALLORAN
Editor

GERALD M. BEST
Technical Editor

H. W. DICKOW
Advertising Manager

Branch Offices:

New York City, 17 W. 42nd St.
Chicago, 307 N. Michigan Ave.
Boston, 52 Irving St.
Kansas City, Mo., Davies & Dil-
lon, 707 Land Bank Bldg.

Rates:

Issued Monthly, 25c a copy.
Subscription price \$2.50 per year
in the U. S., \$3.00 per year else-
where.

Correct Addresses:

Instructions for change of ad-
dress should be sent to the pub-
lisher two weeks before the date
they are to go into effect. Both
old and new addresses must al-
ways be given.

Advertising:

Advertising Forms Close on the
First of the Month Preceding
Date of Issue.

Member Radio Magazine Publishers' Association
Entered as second-class matter at Post Office at San Francisco, Calif.
Copyright 1925 by the Pacific Radio Publishing Co.

Address all communications to

Pacific Radio Publishing Company

Pacific Building, San Francisco, California

VOLUME VIII

JANUARY, 1926

NUMBER 1

CONTENTS

	PAGE
RADIATORIAL COMMENT	9
THE RADIO DETECTIVE.....	10
AN EXCEPTIONAL FOUR-TUBE RECEIVER.....	12
By Edwin E. Turner	
A 1926 ALL-WAVE GENERATOR.....	17
By McMurdo Silver	
THE ART OF SOLDERING.....	19
By Kirk B. Morcross	
THE TIME TOTALER.....	20
By Keith LaBar	
AN EFFICIENT ONE-TUBE SET.....	21
By E. M. Sargent	
SHORT WAVE STATIONS.....	22
POTATO PEELINGS	23
By Gerald F. Dunn	
HORNLESS TYPES OF LOUD SPEAKERS.....	24
By Dr. John P. Minton	
VACUUM TUBE RESISTORS.....	25
By G. F. Lampkin	
MODERNIZING AN OLD RECEIVER.....	27
By D. B. McGowan	
PROPER REFLEX CIRCUIT ASSEMBLY.....	29
By L. W. Hatry	
THE LOWLY LOW-LOSS.....	30
By Jack Bront	
SPEECH MODULATION METHODS.....	31
By Jennings B. Dow	
A GOOD SHORT-WAVE RECEIVER.....	33
By Frank C. Jones	
RADIO IN AUSTRALASIA.....	34
By Ivan M. Levy	
RADIO AS AN AID IN RECORDING EARTHQUAKES.....	35
By G. M. Best	
RADIO IN THE FIJI ISLANDS.....	36
AN IMPROVED MULTI-WAVE RECEIVER.....	37
By Willis L. Nye	
THE REGENO-NEUT	38
By Carlos S. Mundi	
QUERIES AND REPLIES.....	39
WITH THE AMATEUR OPERATORS.....	40
FROM THE RADIO MANUFACTURERS.....	42

Forecast of Contributions for February Issue

With this issue RADIO welcomes to its subscription lists the subscribers to the RADIO JOURNAL, whose unexpired subscriptions will be filled by RADIO. It is hoped that space may soon be found to publish some of the features which served the former readers of RADIO JOURNAL and that the combination of the two magazines will result in better service to all readers.

Lloyd Jacquet, as one result of a recent trip to France, has contributed an interesting article on "The Eiffel Tower Short Wave Transmitter" as developed by the French Signal Corps.

Chas. H. Smith describes the theory and construction of a new non-oscillating five-tube tuned radio frequency set which does not need stabilizers, neutralizing condensers or other oscillation controls.

E. M. Sargent, in his next installment of receiving set circuits, tells how to make a two-tube set with one of the former sets as the basis of construction.

Kirk B. Morcross in "Getting Straight on Receiving Tubes" clearly and simply explains the meaning of the symbols used to describe the newer tubes, making it possible for the reader to easily differentiate between them.

H. W. Armstrong will describe a two-stage power amplifier which may also be used as a B battery eliminator and is appropriate for use with the Best superheterodyne described in August, 1925 RADIO.

Jennings B. Dow presents complete information on "Vacuum Tubes for Transmitter Sets," showing some unusually good pictures.

G. M. Best, whose article on "The ABC Eliminator" has caused much favorable comment, shows several improvements and methods for adapting it to other circuits. He will also describe his new 50-watt transmitter.

Geo. S. Turner has written an interesting story about "Financial Returns on Radio."

Frank C. Jones has completed a long period of research on "Parallel Wire Short Wave Oscillators" and gives the benefit of this work to the reader.

Harry Diamond in "Experiments With Radio Receiving Circuits" details best methods for quantitative measurement of the operating characteristics of any receiving circuit and the effects of changes in the circuit.

"Superheterodyne Suggestions," by L. W. Hatry, explains many points about theory and operation that should greatly aid those who are using these sets.

Philip N. Emigh has some good ideas about rebuilding condensers that will save money for the radio constructor.

T. C. Goodner has devised "An Effective Radiation System," a description of which he passes on to his fellow amateurs.

The fiction feature "From Ariel to Ground" by David P. Gibbons, a commercial operator, rivals Jules Verne and Mark Twain in its humorous prophecy of future radio development.



⚡
“These Eveready Batteries are the correct size for your set. With average use they will last you a year or longer”
⚡

“YOU have been one of the many who use ‘B’ batteries that are too small in capacity for their receivers. That is not economical. It makes you buy ‘B’ batteries twice as often as necessary. Fit the right size Evereadys to your set and add a ‘C’ battery,* if you haven’t one, and you’ll get the maximum of service at the minimum of cost.”

The life of your Eveready “B” Battery depends on its capacity in relation to your set and how much you listen in. We know, through a careful investigation, that the average year-round use of a set is

*NOTE: In addition to the increased life which an Eveready “C” Battery gives to your “B” batteries, it will add a quality of reception unobtainable without it.

two hours a day. Taking that average we have proved over and over that on sets of one to three tubes the No. 772 Eveready “B” Battery used with a “C” battery will last a year or longer. On sets of four and five tubes, the larger Heavy Duty Eveready Batteries used with a “C” battery will last eight months or more.

Here is the secret of the utmost “B” battery satisfaction and economy:



LEFT—Eveready Layerbilt “B” Battery No. 486, 45 volts, for maximum economy on four, five or more tubes.

RIGHT—Eveready Dry Cell Radio “A” Battery, 1½ volts. The battery built especially for dry cell tubes.



EVEREADY

Radio Batteries

—they last longer

With sets of from 1 to 3 tubes, use Eveready No. 772.

With sets of 4 or more tubes, use either the Heavy Duty No. 770, or the even longer-lived Eveready Layerbilt No. 486.

We have prepared for your individual use a new booklet, “Choosing and Using the Right Radio Batteries,” which we will be glad to send you upon request. This booklet also tells about the proper battery equipment for use with the new power tubes.

Manufactured and guaranteed by
NATIONAL CARBON CO., Inc.
 New York San Francisco
 Canadian National Carbon Co., Limited
 Toronto, Ontario

EVEREADY HOUR
EVERY TUESDAY AT 9 P. M.
Eastern Standard Time

For real radio enjoyment tune in the “Eveready Group.” Broadcast through stations—

WEAF—New York WFI—Philadelphia WSAT—Cincinnati
 WJAR—Providence WGR—Buffalo WWJ—Detroit
 WEEI—Boston WCAE—Pittsburgh WOC—Davenport
 WTAG—Worcester WCCO—Minneapolis, St. Paul KSD—St. Louis

Tell them that you saw it in RADIO



When a Finer Transformer Is Made It Will Bear This Name-Plate

Radio moves rapidly. Perhaps some time there may be seen a *better* transformer than what we *now* know as Rauland-Lyric. It may sell at \$9, or \$10, or \$15, or \$7. But the careful observer of the past year's developments will entertain not a moment's doubt of one thing: when the better transformer comes it will come beneath the famous Rauland-Lyric name-plate. Behind this as a pledge rests the entire organization and resources of the All-American Radio Corporation

Rauland-Lyric is easily obtainable from better-class dealers everywhere. The price is nine dollars. Descriptive circular with technical data may be had on request to All-American Radio Corporation, 4201 Belmont Avenue, Chicago

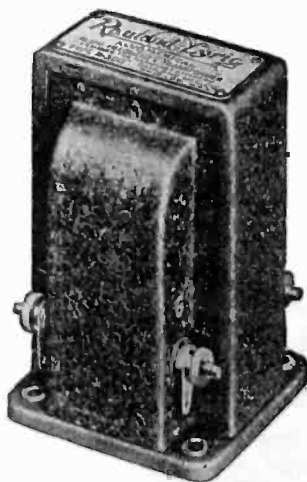

Rauland-Lyric tone quality is now available in a complete receiver: the new All-American Model R (a five-tube tuned-radio-frequency set) now being shown. If your preferred dealer does not display it, send to us for descriptive booklet

Tell them that you saw it in RADIO

RADIO 'RITHMETIC



QUESTION:

What's the Difference Between
Good and Poor Radio Reception?

ANSWER:

A RECTIGON!

NO storage - battery
radio is complete
without a
RECTIGON.

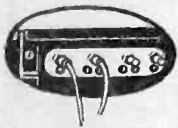

TO recharge one or two-cell
radio "A" batteries with a
Rectigon, merely adjust "snap"
terminals as shown above. Takes
but a moment.

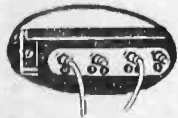

TO recharge three or six-cell
radio "A" or automobile bat-
teries merely adjust "snap" termi-
nals as shown above. Very simple.

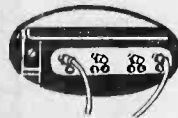

TO recharge eleven to forty-
eight-cell "B" batteries merely
adjust "snap" terminals as shown
here. (An instruction sheet packed
with every Rectigon.)

THERE'S no muss or fuss with
a Rectigon. No acids, no
chemicals, no moving parts and no
noise.

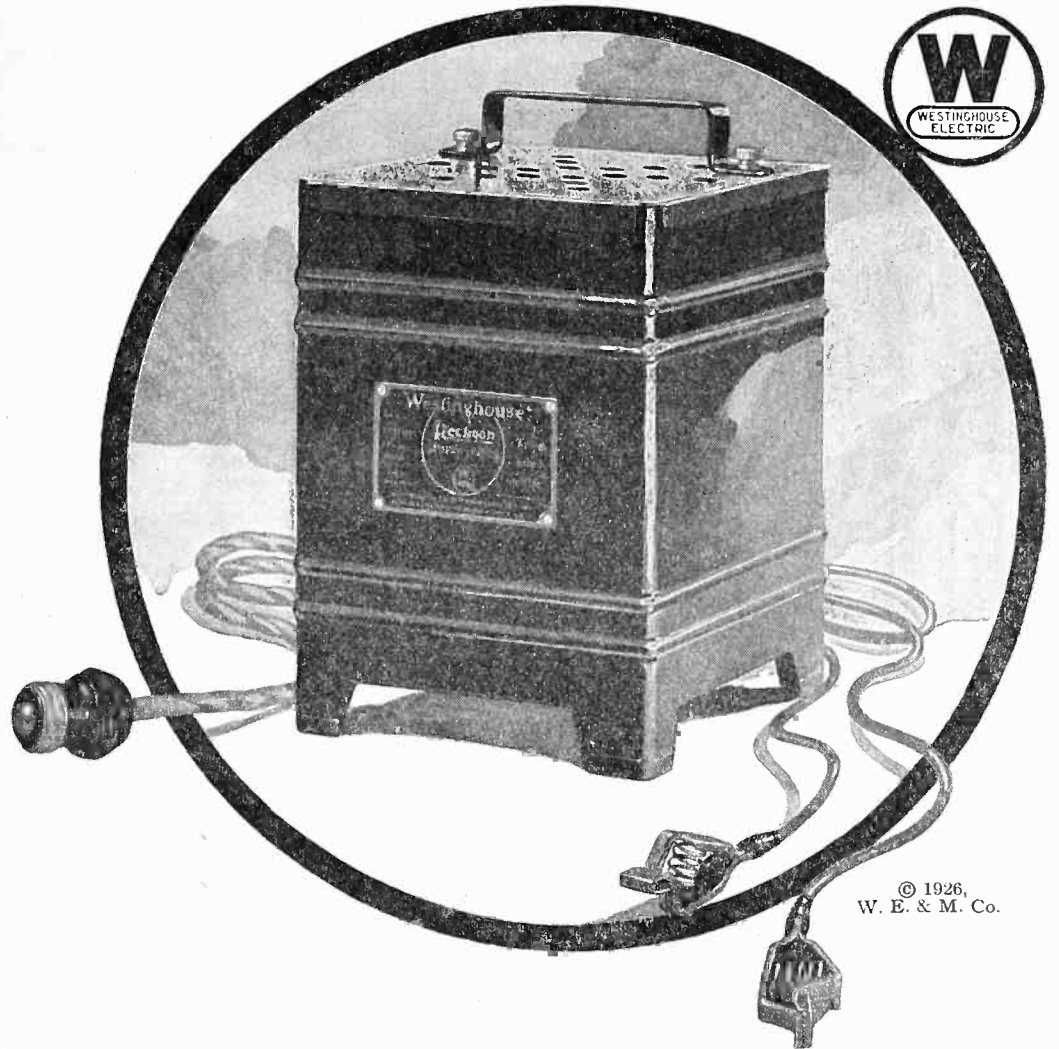

© 1926,
W. E. & M. Co.

THE Rectigon offers a real solution to the oft-re-
peated question, "What's the matter with my set?"
Ask any owner of a Westinghouse Rectigon. There are
radio fans by the thousands to tell you there's no better,
surer way to keep your batteries full of pep *than with*
a Rectigon.

WESTINGHOUSE ELECTRIC & MANUFACTURING CO., SOUTH BEND, INDIANA

The **Westinghouse** **Rectigon Battery Charger**

Westinghouse manufactures, also, a complete line of Micarta radio panels, Micarta tubes and instruments.

Tell them that you saw it in RADIO



HEAR THIS EXTRAORDINARY THOMPSON RECEIVER

Thompson Minuet

A 5-tube dry-cell Thompson Receiver combined with improved cone-shaped speaker, enclosed in a newly developed Thompson sound chamber, producing full, natural tones, on low, as well as high notes. All batteries are dry cells and are self-contained. If necessary, will operate on a wire around the picture moulding. Size—21½ inches high, 18½ inches wide, 10½ inches deep. Price \$139 (slightly higher west of the Rocky Mountains and in Canada). Other Thompson Receivers, \$89 to \$360.

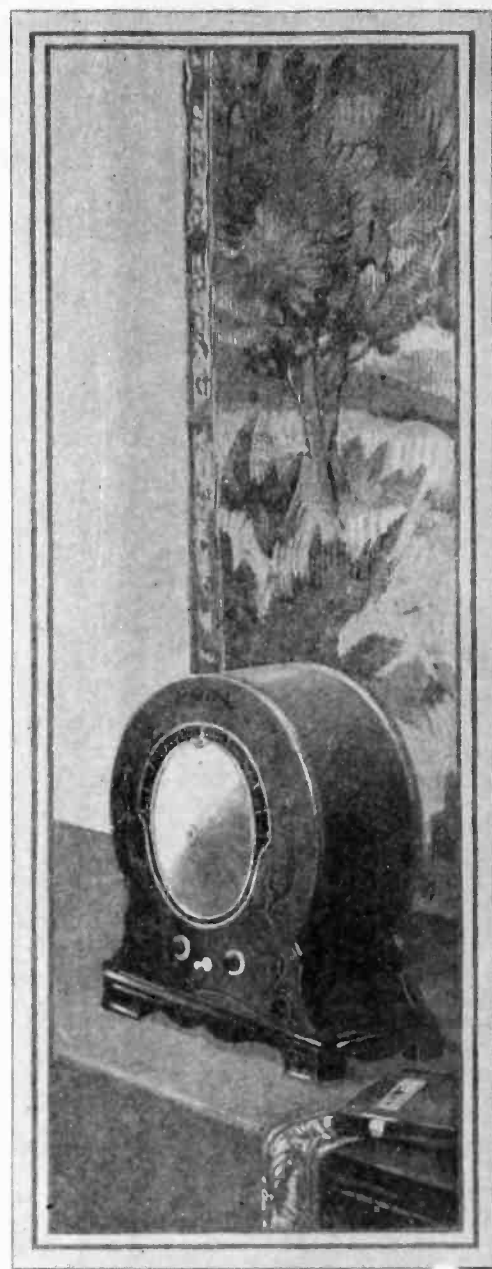

TOMORROW'S receiver *today*—the Thompson Minuet. New in appearance, new in operation, new in performance.

The beautiful mahogany cabinet is unique in shape. It incorporates the acoustic principles of the violin and 'cello. And such natural quality! The Thompson Minuet reveals to you what progress has been made recently in broadcast transmission, for it is as modern as are the latest

transmitters. New pleasure in radio is yours when you operate a Thompson.

There is only a single tuning lever, which moves over the long scale covering half the circumference of the speaker. It is a new sensation in radio to operate and certainly a new sensation to hear the Minuet. Simply swing the control lever over the scale and the stations come in one following the

other. All batteries, "A," "B" and "C," are contained within the case, and the only external connections needed are to antenna and ground.

The Thompson Minuet is sold by the better dealers everywhere. They are glad to let you see it, operate it, hear it. Investigate this instrument, the product of fifteen years' radio experience. R. E. Thompson Mfg. Co., 30 Church St., New York City.

THOMPSON RADIO

BUILT BY MAKERS OF ARMY AND NAVY RADIO APPARATUS USED BY LEADING NATIONS

Tell them that you saw it in RADIO

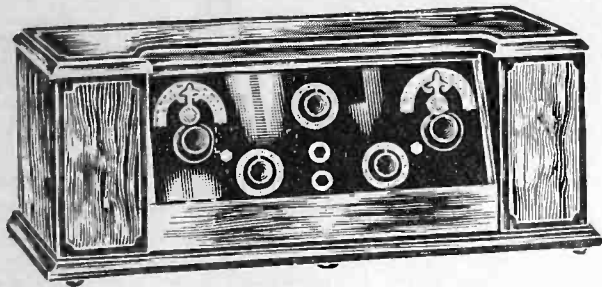

**CROSLEY
SUPER-TRIRDYN SPECIAL**

The improved Super-Trirdyn panel is assembled in a new solid mahogany cabinet finished in duotone. This cabinet with its striking lines and simple detail decoration, is of ample size to house all dry batteries required for dry cell tube operation..... **\$60.00**

Performance
that has no peer in
any field of radio

Since the announcement of the present new Crosley models, Crosley sales have been leaping to sensational figures, literally taxing the production facilities of all Crosley plants.

This new leadership in sales is based on Crosley's new leadership in value; and this latter resolves itself into two simple propositions:

Crosley sets consistently deliver a performance that has no peer in any field of radio—and this matchless performance is offered at the lower prices that only the economies of tremendous production make possible!

On this page are shown four of the new Crosleys—the two famous Super-Trirdyns and the two Special DeLuxe models. Not only do they offer an effective beauty and accurate workmanship, but they provide a performance that cannot be surpassed in the \$23.50-\$60.00 price range or many dollars above it!

Make your own comparison on the basis of selectivity, distance, clarity and volume. Place the competing receivers side by side with lead-ins from the same antennae, and put them through their paces.

Forget the radical difference in price. Reach your conclusion solely on results. Then and only then will you understand why thousands upon thousands of radio buyers are singling these Crosleys out of the entire field—unwilling to pay more because a greater investment cannot provide greater enjoyment.

See the complete Crosley line at the nearest Crosley dealer's. Address Department 19 for his name and our illustrated catalogue.

The Crosley Radio Corporation, Cincinnati, Ohio

Cable Address: Listenin-Cincinnati

Owning and Operating WLW, First Remote Control Super-power Broadcasting Station.

Crosley manufactures receiving sets which are licensed under Armstrong U. S. Patent No. 1,113,149 and priced from \$9.75 to \$60.00 without accessories. None of the prices quoted include batteries, tubes, headphones, etc. Add 10% to all prices west of the Rocky Mountains.

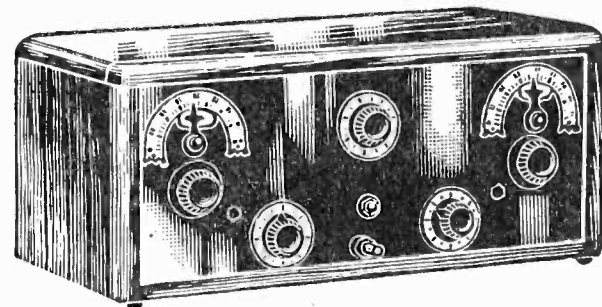

**CROSLEY
SUPER-TRIRDYN REGULAR**

Incorporating the famous Trirdyn hook-up, this set brings in stations sharp, clear and mellow on the Musicone. The cabinet is of oil rubbed solid mahogany, exquisitely simple in design and beautifully finished. For sheer performance under all conditions the Super-Trirdyn cannot be surpassed..... **\$45.00**

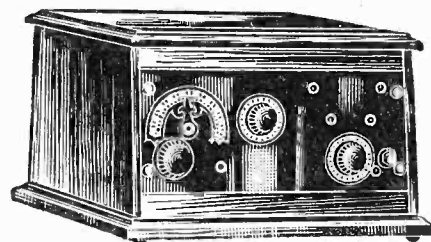

**CROSLEY
3-TUBE 52 S. D.**

In this improved model are introduced radical refinements that increase its general efficiency. Refinement of parts and improvements in design have made it a truly remarkable price considering its nominal price. Genuine Armstrong regeneration with the double circuit to reduce radiation to a minimum. Beautifully proportioned with attractive sloping panel. Cabinet holds all necessary dry cells. A genuine long-range radio, easy to tune, easy to enjoy, and easy to pay for..... **\$32.50**

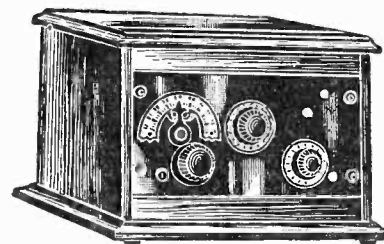

**CROSLEY
2-TUBE 51 S. D.**

This superb long range set combines Armstrong regeneration and one stage of audio frequency amplification. The handsome mahogany finished cabinet, with sloping panel, holds all required dry batteries. Improvements include new worm type tickler, new vernier plate condenser, and a double circuit to minimize radiation. Unusual selectivity and distance, extreme accuracy of control..... **\$23.50**

CROSLEY · RADIO

BETTER · COSTS LESS

Tell them that you saw it in RADIO

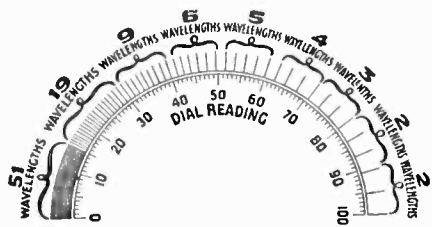

Ordinary Condenser Arrangement of Wavelengths

Ordinary straight capacity condensers crowd 70 of the 100 wavelengths into the first 30 points of the dial.

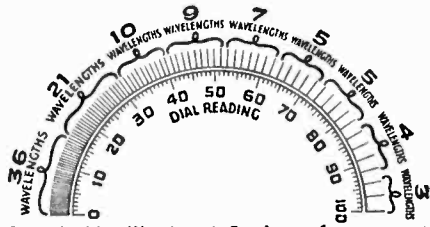

Straight Line Wavelength Condenser Arrangement

With straight-line-wavelength condensers 57 of the 100 wavelengths are crowded into the first 30 points of the dial.

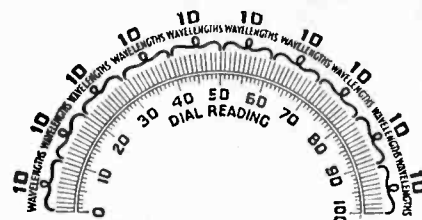

KARAS ORTHOMETRIC CONDENSER Arrangement of Wavelengths on Dial

The New, Scientific Karas Orthometric Condensers insure absolutely equal separation on the dial of all wavelengths throughout the entire broadcasting range.

Tuning Marvelously Simplified with Karas Orthometric Condensers

The condenser that brings in KDKA where it belongs — at 53 on the dial. Remember, 52 of the 100 allotted wavelengths must come in below KDKA.

Note the Long Eccentric Plates

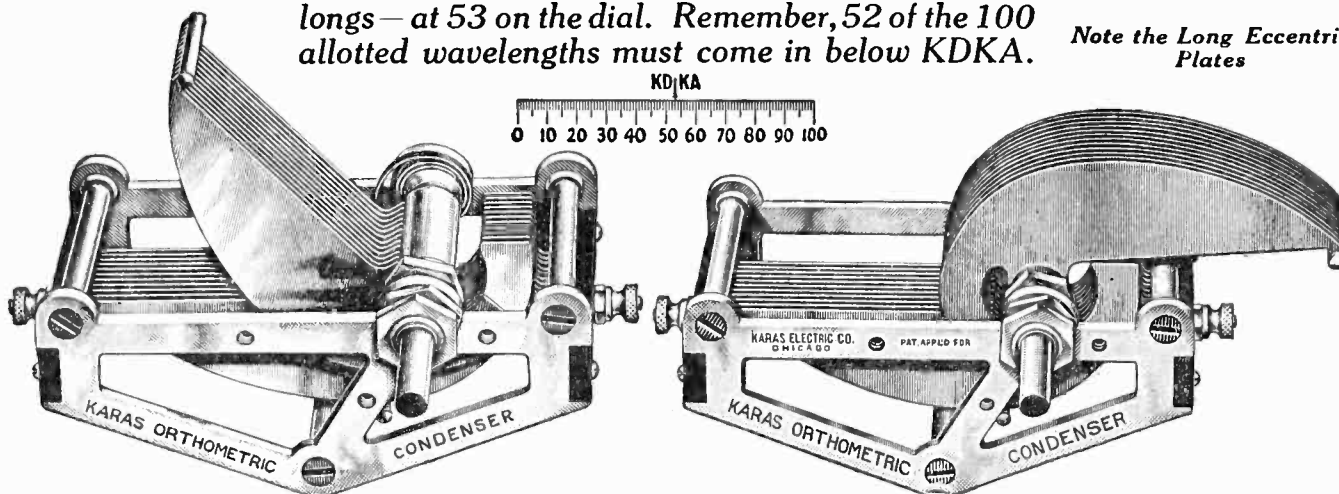

Spreads Stations Evenly Over the Dial — No Crowding Whatever

THE Karas Orthometric Condenser positively separates all adjoining wavelengths by EQUAL distances on the dial, giving you the full benefit of the 10 Kilocycle frequency separation fixed by the Government.

Ordinary condensers jam 70 of the 100 Government allotted wavelengths into the first 30 points of the dial — even straight-line-wavelength condensers crowd 57 of them below 30.

With Karas Orthometrics, each point on the dial corresponds exactly to one of the 100 allotted wavelengths. The result is marvelous simplicity in tuning — better, clearer reception — you get all the side bands without interference.

The Karas Orthometric stands absolutely alone! — an eccentric condenser, scientifically designed for present

day broadcast receiving sets—the Last Word in making REAL SELECTIVITY POSSIBLE.

The Karas Orthometric is a “job” that will delight the eye of the mechanical critic. It is made entirely of brass—frame and plates all die stamped—plates, patent leveled and solidly bridged to insure permanent rigidity and alignment. Every joint throughout is soldered. Grounded frame and rotor, with stator plates supported on hard rubber insulation. Tapered adjustable cone bearings, spring copper pigtail connection, automatic stops — in short, a condenser that is both theoretically and mechanically perfect.

If Your Dealer is Not Yet Supplied, Order on this Coupon

Send No Money With this Coupon —

Karas Electric Co., 4057 N. Rockwell St., Chicago
Please send me _____ Karas Orthometric Condensers.
size _____ at \$ _____ each. I will pay
the postman the list price, plus postage, on delivery. It is understood
that I have the privilege of returning these condensers any time
within 30 days if they do not prove entirely satisfactory, and you will
refund my money at once.

Name _____

Address _____

Dealer's Name _____

If you send cash with order, we'll send condensers postpaid.

We are supplying Jobbers and Dealers as fast as the output of our factory permits. If your dealer is not yet supplied, order direct on the coupon. You need send no money with your order. Condensers will be delivered C. O. D., and you receive them subject to our unconditional guarantee of satisfaction. Why run the risk of delay? Order NOW!

Money Back Guarantee

Karas Orthometric Condensers are unconditionally guaranteed to give you absolute satisfaction. They may be returned for full refund any time within 30 days.

SIZES AND PRICES
23 plate, .0005 Mfd., \$7.00
17 plate, .00037 Mfd., 6.75
11 plate, .00025 Mfd., 6.50

Karas Electric Co., 4057 N. Rockwell St., Chicago
For Over 30 Years Makers of PRECISION Electrical Apparatus

RADIO

WITH WHICH IS INCORPORATED "RADIO JOURNAL"

VOLUME VIII

JANUARY, 1926

No. 1

Radiatorial Comment

SUCH wide publicity will have been given to the proceedings of the Fourth Radio Conference by the time these lines are read that most readers will be more interested in an interpretation of the probable effects than in a summary of the recommendations adopted. The outstanding feature of the Conference was the unanimous expression of confidence in the manner in which Secretary Hoover has regulated the industry in the past and the evident desire that the principles established by him be incorporated in the much-needed legislation that Congress is expected to enact.

The main purpose of the Conference—a lessening of interference to radiocast reception—will be greatly aided by the recommendation that licenses not be granted for new stations until more channels are developed. The guiding principle in this, and all other recommendations, was that the public interest, as represented by service to the listener, should be the first consideration governing all regulatory action.

The limitation in number, together with the condemnation of further division of time among stations, means that new stations may come on the air only as old stations are discontinued or lose their licenses because of inadequate service to the public. Although this apparently gives a greater value to a license, it cannot be sold without definite proof that there is no element of speculation involved in the transaction. An air right, like a water right, should not be capitalized.

As the Conferences, as well as the Department, have repeatedly expressed their disapproval of monopoly, there is small likelihood of any combination in restraint of trade among the five hundred and more stations now existing. Furthermore the toll stations offer the opportunity for anyone to secure an audience at less cost than by erecting and maintaining another station. Secretary Hoover has aptly said that "freedom of speech cannot mean a license to every person who wishes to broadcast his name or his wares and thus monopolize the listener's set." Freedom for the listener is considered more important than freedom for the speaker.

The condemnation of radiating receivers does not necessarily mean the dis-use of any particular type of circuit but merely the addition of some anti-radiation device. This can be done at slight expense by means of any one of several methods. But emphasis should be placed against the improper operation which causes a set to radiate disturbance to nearby receivers.

The decision to recommend no changes in present band of radiocast wavelengths represents not only a recognition of the useful work of the amateurs, whose territory would otherwise be invaded, but also a due consideration for the owners of sets which will not tune below 200 meters. The opening up of the lower band would give only temporary relief and the refusal to do so was in accord with the general thought that fewer and better stations are needed.

The lack of change in the rules governing increase in power is a tacit admission that the much-feared bugaboo of super-power is groundless, especially when the high power stations are distant from congested areas, as recommended for new stations. Eliminating the distinction between class A and B stations will allow high-power stations in the lower wavelengths. But no station of 500 watts or more may use mechanically produced music. The large stations will serve large areas and the small stations will continue to serve their individual communities.

Salutary results should accrue from the recommendation that station owners be urged to safeguard their programs against the intrusion of any form of publicity which is objectionable to the listener. This does not involve any outside censorship but leaves to each station the determination of what will create good or ill will in the minds of its listeners. The reputation of a station, also, as to the mechanical quality of its output, will be protected by the recommendation against any unauthorized re-broadcasting of its programs by other stations.

Although the Conference was unable to arrive at any constructive solution to the problem of the use of copyrighted music by stations, due to the lack of agreement as to the proper basis of compensation for such use, the issue was clearly defined for possible legislative action. This is the only case considered by any of the Conferences where a satisfactory answer has not been given by mutual concession or amicable agreement. The music publishers will concede nothing and the only remedy is a new copyright law.

It should be remembered that these various recommendations merely constitute advice to the Department. Several of them cannot be made effective until Congress passes a bill empowering the Secretary of Commerce to fulfill their intent. Consequently the real results of the Conference must await legislation vesting him with the necessary authority subject to court appeal, to issue and suspend licenses in accordance with the general principles here outlined. It is in this law that it is hoped that the earnest work of the conferences may find its fruition.

The Radio Detective

Compact Motorized Equipment Used by the 8th District
Radio Inspector for Locating Interference

ANYBODY who has been bothered by mysterious and unaccountable interference—and who has not been so disturbed?—will welcome the new agency devised to locate the source of the trouble, by Supervisor S. W. Edwards and his assistants in the Eighth District. This agency is a Packard chassis equipped with the most modern equipment for tracing the offending electrical fault. It attracted great attention at the Fourth Radio Conference at Washington, whither it had been driven from Detroit. It is the model for what is hoped will soon be standard equipment in each of the nine radio districts.

Probably so many and so varied pieces of radio apparatus were never before assembled in such neat, compact and portable form. They constitute all of the material necessary for the conduct of a radio supervisor's office and will be so used. Accurate tests can quickly be made of the strength or field intensity of a transmit-

ting station at widely separated points. Determinations of broadness of tuning, location of radiating receivers, detection of faulty power lines and any of the numerous other services required of a radio inspector on land can easily be accomplished with its aid. Examinations for licenses can be held at many points throughout the district without the necessity of the applicant's going to any central point. So convenient and economical is this new method that it should cause a tenfold increase in the efficiency of the inspection personnel.

These several advantages may be best appreciated by considering each of the separate instruments and their respective functions in turn. The first instrument to be seen at the left as you enter the car through a door at the rear is an induction receiver. This is intended to locate a faulty insulator or other cause of sparking in a power line. Its antenna is a Kolster Direction Finder, a rotatable loop which is turned until the

noise caused by the electrical fault becomes loudest in the headphones or loudspeaker with which the receiver is equipped. Having one stage of radio frequency amplification, detector and one stage of audio, this receiver can detect the interference at a great distance from the source. Then as the car is driven nearer and the sound becomes louder, the several amplifiers are successively cut out until only the detector is functioning. By rotating the loop and moving the car until the sound is at a maximum, its source can be located within a few feet and steps are then taken to correct it.

The loop is placed at the forward end of the car, just behind the driver's seat. It may be connected to any one of the several instruments, or in some cases an antenna inside the car may be used. The next instrument is a short wave amateur receiver covering the band from 40 to 180 meters. This is a three-circuit regenerative set having one stage of audio.



Interior View of Car, Showing Arrangement of Testing Apparatus.

It employs regenerative feedback and is normally used with the inside antenna. Its design is conventional and its function obvious, so no further comment is necessary.

Adjoining it is a special piece of apparatus designed by the engineers of the U. S. Bureau of Standards. This is an exceedingly simple instrument for measuring the field strength of a radio-casting station. This measurement is read directly on a meter and by means of a calibration chart converted to milli-amperes per meter length of the antenna. Thereby it is possible to make an accurate survey of the territory served by the station with any given strength of signal.

This instrument is so beautiful in design and so useful to experimenters that its circuit diagram and constants are shown herewith. It consists of a three stage resistance coupled amplifier, with vacuum tube voltmeter, and associated variable resistances. For operation, the set is tuned with the variable condenser placed across the loop, and listening with the headphones, the signal is adjusted to maximum intensity. The phones are then disconnected and the plate current in the vacuum tube voltmeter is balanced by adjusting the 300 ohm potentiometer, until a zero reading is obtained in which ever ammeter is used. The deflection is proportional to the field strength and a calibration may be made when the set is first constructed in arbitrary units. The values of condensers, resistances and other apparatus are given on the diagram, the tubes used being of the type 199, with 3 volt filament supply.

The last piece of apparatus on the shelf, running along the left side of the car is a Kolster direction finder receiver, such as is ordinarily used with the Kolster loop on shipboard. This is a six tube set, three stages of radio, detector and two audio. It now covers the range from 200 to 1000 meters but can be modified to also cover the short wave amateur band.

On the right hand shelf, behind the driver's seat, which is separated from the rest portion of the car by a sliding glass panel, is a complete switchboard for controlling all the radio equipment and the overhead lighting system. Through fused circuits it distributes filament and plate voltage, controls the charging of the batteries and the operation of the dynamotor.

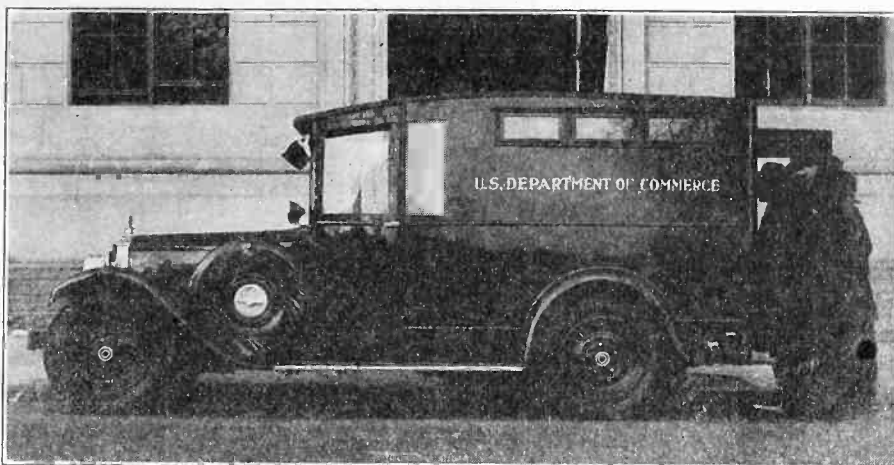

Radio Equipped Car.

Primary power is obtained from eight 155 ampere-hour storage batteries, which may be thrown in any series-parallel combination desired. These batteries may be charged either from an alternating current lighting source while the car is at rest, or individually from the car generator while in motion. Plate current at 1500 volts, .230 amperes, for operating a 50-watt oscillator is secured from a dynamotor driven by power from the batteries. These have sufficient capacity to operate continuously for six hours.

Next to the switchboard is an eight-tube superheterodyne receiver equipped with removable coils to cover the band from 50 to 3500 meters. Adjoining it is a transmitting key and space for either a Kolster Decremeter or a quartz crystal oscillator for measuring the wavelength of a transmitting station. The last piece of apparatus on the right hand shelf is a 50-watt oscillator which is used either in the wavelength measurements or as a transmitter. The benefit of such a portable transmitter for emergency communication during storms, floods or other accidents is very great. It can be readily converted to use a 5-watt instead of a 50-watt tube and employs a Hartley circuit, with toroidal coils to cover the various frequencies.

Underneath the shelves supporting these various instruments are drawers and cupboards for a typewriter, an omnigraph for license examinations, stationery, spare parts and a portable superheterodyne receiver for use where the automobile cannot go.

Thus all the duties of an inspector may be performed as he travels through

his district. The construction of this first car, at a cost of less than \$6000 complete, was made possible by reducing the appropriation to each of the other radio districts. In view of the emphatic endorsement given it by the Fourth radio conference and because of its convenience and economy in accomplishing the work required of the radio inspectors, it is earnestly hoped that Congress will make a sufficient appropriation to equip each district with a similar car.

RADIOCASTING IN RUSSIA

The popularity of radio in the Union of Soviet Socialistic Republics, as Russia is now called, has not reached the proportions it has attained in other European and Oriental countries, according to the report contained in an interesting letter received from our Russian correspondent, Mr. A. Kalachnikoff, of Tomsk, Siberia.

The main Russian station is located at Moscow, and is known as the Commune Internationale Broadcasting Station. It has an output power of 12 kilowatts, and operates on a wavelength of 1450 meters, radiocasting concerts daily from 4:30 to 7 P. M., Greenwich Standard Time. Another station located in Moscow is owned and operated by A. S. Popov, on a wavelength of 1010 meters, with output power of 12 kilowatts. Two new stations will soon be installed at Tomsk, Siberia, which is one of the principal cities of that province, and by which it is hoped to increase the interest in radio in Northern Asia. Amateurs are now licensed for receiving only but, are prohibited from transmitting, so that it will probably be some time before American amateurs will have the pleasure of working inland stations in Siberia.

Thin sheet celluloid, which may be easily obtained from automobile supply stores, makes a fine insulator for coils, and other parts, where a good flexible sheet insulator is needed.

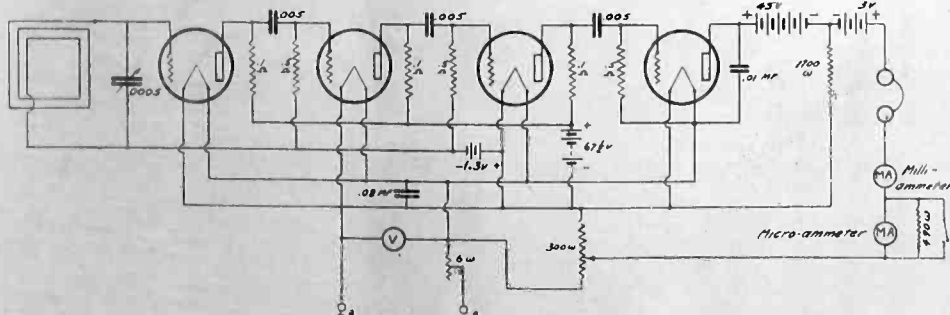

Diagram of Field Strength Measuring Set

An Exceptional Four-Tube Receiver

A Modification of the *LC* Circuit Described in Oct. 1925 *RADIO*
Employing Standard Coils and Adaptable to Batteryless Operation

By *Edwin E. Turner*

Due to the tremendous interest created by the *LC* circuit described in October, 1925 *RADIO* and the great success and satisfaction of those constructing sets in accordance with the directions there given, many readers will welcome the simplification in construction that is made possible by using the ready-made coils that are now available instead of having to wind the space-wound coils utilized in the original receiver. Several modifications are here introduced in the interest of simplicity. While the set is extremely selective, this can be still further improved by using a condenser-tuned primary as is used in the Victor-Northern Electric R-30, whose circuit is otherwise practically identical with that here described—EDITOR.

WHILE none of the many different circuit arrangements brought forward during the past two years has proven revolutionary, those incorporating one stage of tuned radio frequency amplification, a regenerative detector and some good method of audio amplification have enjoyed tremendous popularity and earned the right to be called standard. No other four-tube circuit combines sensitivity, selectivity, lack of radiation and ease of tuning to a greater degree.

Of the various modifications of this

circuit, great satisfaction has been given by one employing the Rice method of neutralization to eliminate oscillation in the radio frequency tube and a fixed tickler shunted by a variable losser to effect regeneration in the detector, which makes tuning independent of the feedback control. By using properly designed audio transformers with large cores and sufficient primary impedance the finest sound quality may be secured with ample loud speaker volume by means of two stages of low-ratio audio amplification.

Not the least of the circuit's features is its low *B* battery consumption. A *C* battery is used on the r. f. tube as well as on the two audio frequency amplifiers. The use of a negative grid bias on the radio frequency amplifier is made possible through the unusually effective neutralization method employed with it. Its adaptation for use with an ABC eliminator is described at the end of this article.

Quality is greatly to be desired. It can be obtained by using the proper inter-stage coupling devices in the audio

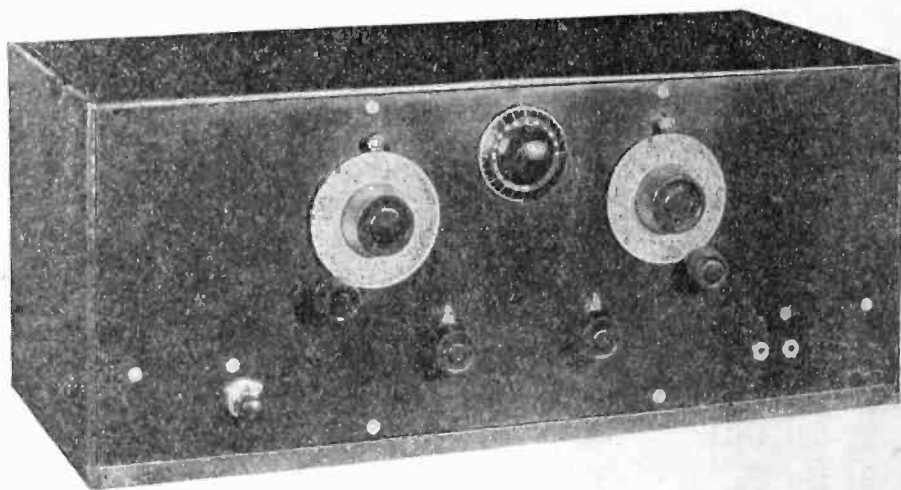

Completely Assembled Receiver.

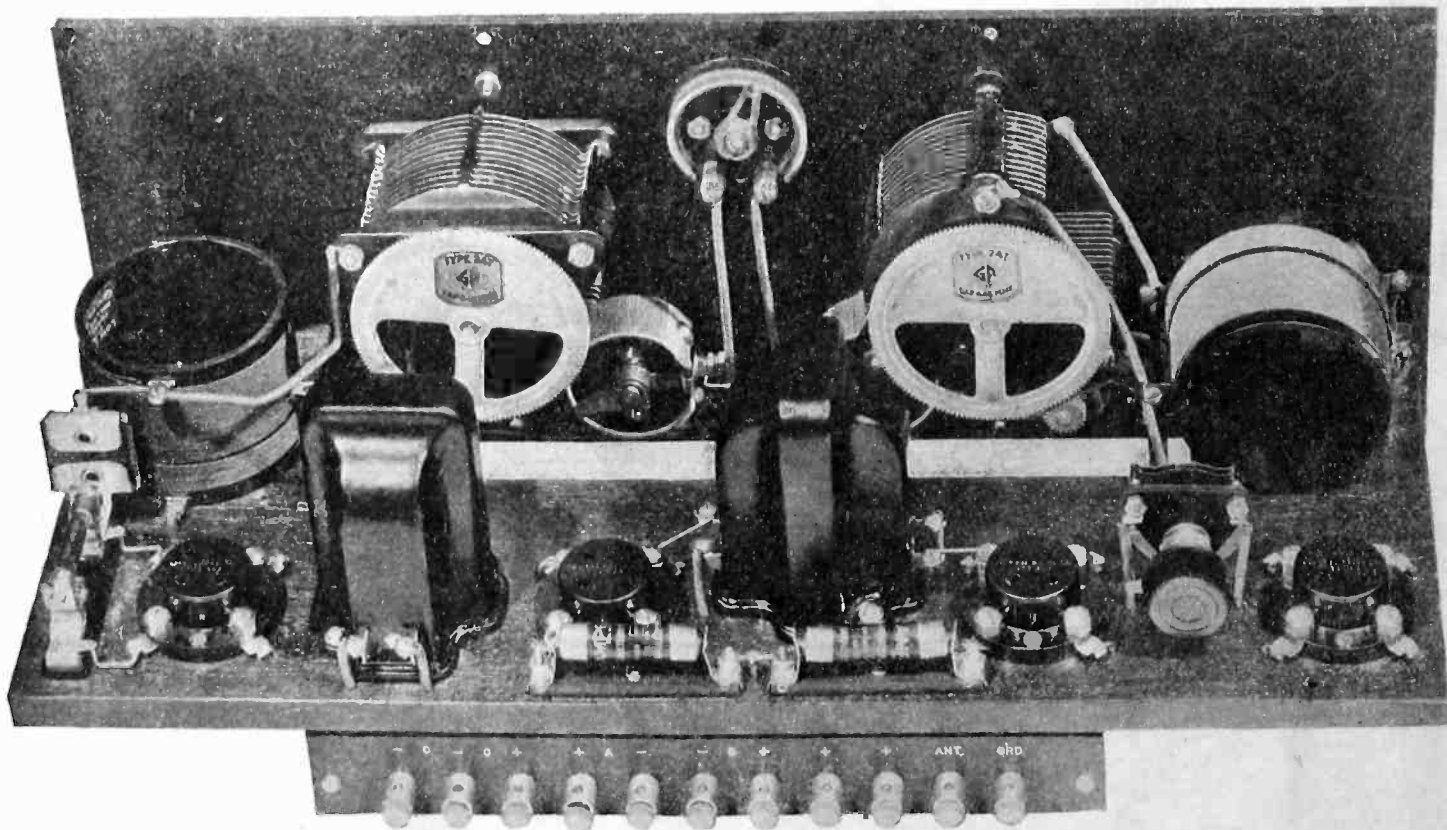

Rear View, Showing Baseboard Layout

amplifier, by avoiding too great selectivity at radio frequencies, with its attendant cutting of side bands, by using tubes in successive audio stages capable of handling the output of the preceding stage without overloading, by using the proper grid bias and plate potential, by burning the tubes at the proper point to secure adequate electron emission and by matching the plate impedance of the last tube with that of the speaker to be used with it.

These matters have been given proper consideration in the design of the circuit shown herewith. The new UX sockets are used so that tubes of the UX 201-A or UX 199 types may be used interchangeably. When UX 201-A tubes are used the UX 112 is strongly recommended for the last audio stage, with a plate voltage of 135 and a negative grid bias of 9 volts. If tubes of the UX 199 type are employed in the first three sockets, the UX 120 should be used in the last socket, also with a plate voltage of 135, but with a negative grid bias of 22½ volts.

The method of coupling the radio frequency amplifier and the detector is similar to that used in the "LC Circuit" described in October, 1925 RADIO in employing an auto-transformer with part of the detector grid coil used as the plate coil of the radio frequency amplifier. By this expedient the coupling coefficient between primary and secondary is high and electromagnetic leakage between the two windings is low. In addition the voltage amplification factor of the transformer is secured, combining the advantages of transformer and impedance coupling. The circuit differs from the "LC Circuit" in using inductive instead of capacitive feedback.

Much has been done by other investigators toward the design of a satisfact-

LIST OF PARTS USED BY AUTHOR

- 2 Variable condensers, .0005 mfd., with dial.
- 1 Binding post strip.
- 11 Binding posts.
- 2 Inductance coils—General Radio type 277-D.
- 1 1 mfd. by-pass condenser—Tobe-Deutschmann, Dubilier.
- 1 Neutralizing condenser—General Radio type 368.
- 2 Filament ballast cartridges—Amperite, Braeh, Daven.
- 2 Audio transformers—2 to 1 ratio.
- 1 2 megohm grid leak with mtg.
- 4 Sockets for UX type tubes—General Radio 340.
- 1 Variable resistance—500-50,000 ohms—Royalty, Electrad, Centralab.
- 2 30 ohm rheostats—General Radio type 301.
- 1 Filament switch.
- 1 2 spring jack.
- 1 .00025 mfd. fixed mica condenser, with grid leak clips.
- 1 .002 mfd. fixed mica condenser.
- 1 .0001 mfd. fixed mica condenser.
- 1 Panel 7x18x3-16 in.
- 1 Baseboard as shown in Fig. 4.

ory transformer with which to couple together the radio frequency tube and the detector. However, the necessity for reducing the inherent capacity between

the primary and secondary windings for good amplification at low wavelengths, has made necessary the placement of the primary so that there is considerable magnetic leakage and comparatively low coupling at the long wavelengths. The result is an amplification curve of a somewhat falling characteristic on the upper wave band. With the auto-transformer method just outlined a surprisingly high value of amplification is secured over the entire radiocast band. Whatever decrease in signal strength is observed on the long wavelengths may be attributed more to the semi-aperiodic or untuned antenna coupling than to the interstage coupling device. Since the radio tube has its plate connected directly to the inductance which is also the detector grid coil, the grid leak is connected from the grid of the detector to the positive side of the filament battery. Otherwise the full voltage of the B battery would be applied to the de-

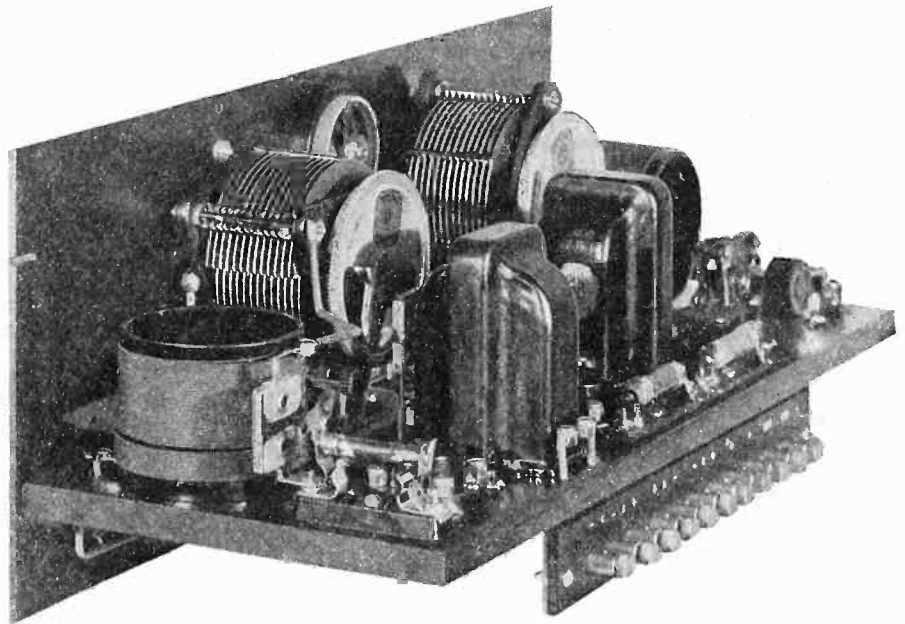

End View of Completed Set.

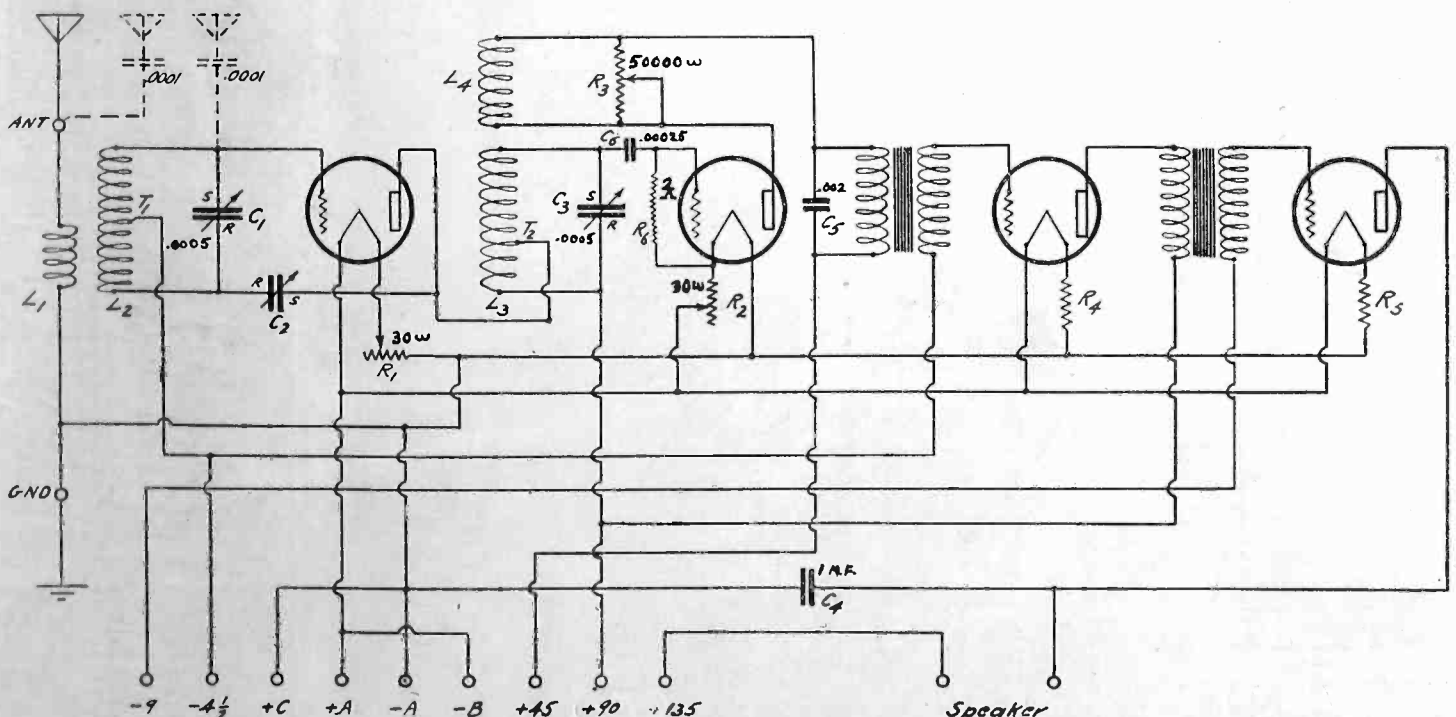

Fig. 1. Schematic Wiring Diagram.

tor grid through the grid leak shunted across the grid condenser in the conventional position.

The circuit diagram is shown in Fig. 1. The coil assemblies L_1, L_2 and L_3, L_4 should be wound according to the following directions: Both transformers are wound on a bakelite or hard rubber tube $2\frac{3}{4}$ in. in diameter and $2\frac{1}{4}$ in. long. The secondaries are wound on first, starting $\frac{3}{8}$ in. from one end, and should consist of 60 turns of No. 22 d. s. c. wire. The winding should end about $\frac{1}{4}$ in. from the other end of the tube. The primary coil is wound over the

stances are marked in Fig. 2, which shows the cross section of the completed coils. These coils are now on the market as shown in the list of parts used by the author.

The variable condensers in the circuit diagram of Fig. 1 are marked to designate the stationary and rotary plates in each instance. The connections as shown are important to eliminate body capacity effects. A separate rheostat is used to control the filament of the r. f. tube and one for the detector. The two audio amplifiers each have a filament control cartridge in the negative leg.

construction. The baseboard should be of dry hard wood of the size shown and $\frac{1}{2}$ in. thick. It is fastened to the panel on the line AA by means of four flat head nicked brass wood screws, 1, 2, 3, and 4. No further support is necessary except for that of the binding post strip in the rear, which projects downward from the baseboard to a distance level with the bottom of the panel. This strip, which is shown in detail in Fig. 5, is fastened to the wooden baseboard with the brass angle pieces of the dimensions shown. Only the center holes are shown in the panel layout, so that the constructor may adapt his panel to whatever material he may use.

The readers' attention is particularly called to the baseboard layout of Fig. 3 with reference to the location of the component parts. The antenna coil and the tuned impedance are located at opposite ends of the baseboard, with a separation of $13\frac{1}{2}$ in. between centers. They are also placed at right angles to each other, the antenna coil lying flat on its side with the grid end of the secondary away from the panel (the primary toward the panel). The tuned impedance is placed upright with the primary

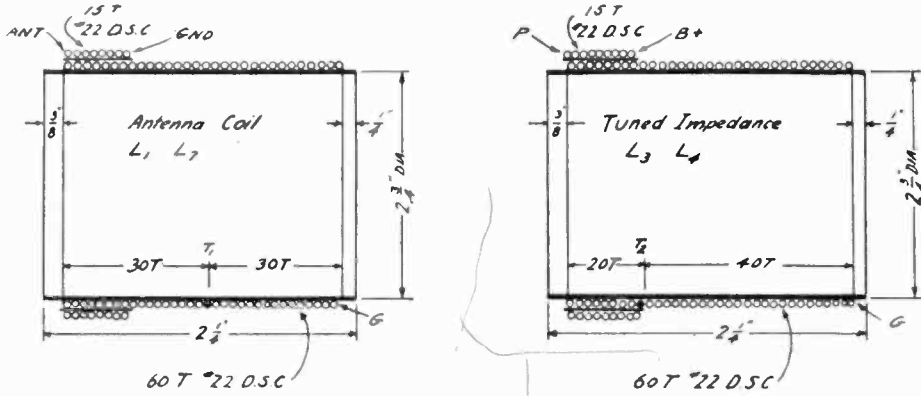

Fig. 2. Specifications for Winding Coils.

secondary and separated from it by a piece of $1/16$ in. cardboard or several layers of empire cloth. The primary should be wound in the same direction as the secondary and should consist of 15 turns of the same wire. A tap T is taken off the secondary of each coil assembly, in L_1, L_2 at T_1 , the exact center of the 60 turns and in L_3, L_4 at a point T_2 , 20 turns from the primary end. In connecting these coils into the circuit it is of the utmost importance that the end of the secondary which is away from the primary be connected to the grid in each case. On the coil L_3, L_4 the primary is used as the fixed tickler, of course. The connections of the primaries in both in-

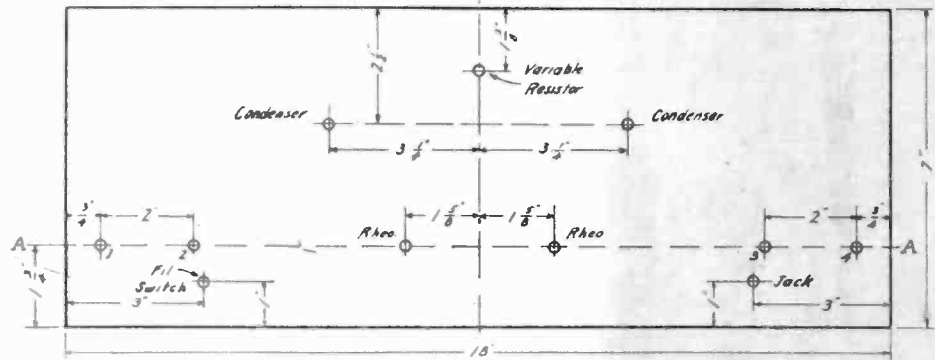

Fig. 3. Drilling Template for Panel.

The panel layout is shown in Fig. 3 and the baseboard layout in Fig. 4. Cutting out the baseboard in this way makes for ease in wiring and convenience in

coil on the bottom. The position of the neutralizing condenser between the r. f. socket and the second audio socket is important for short leads.

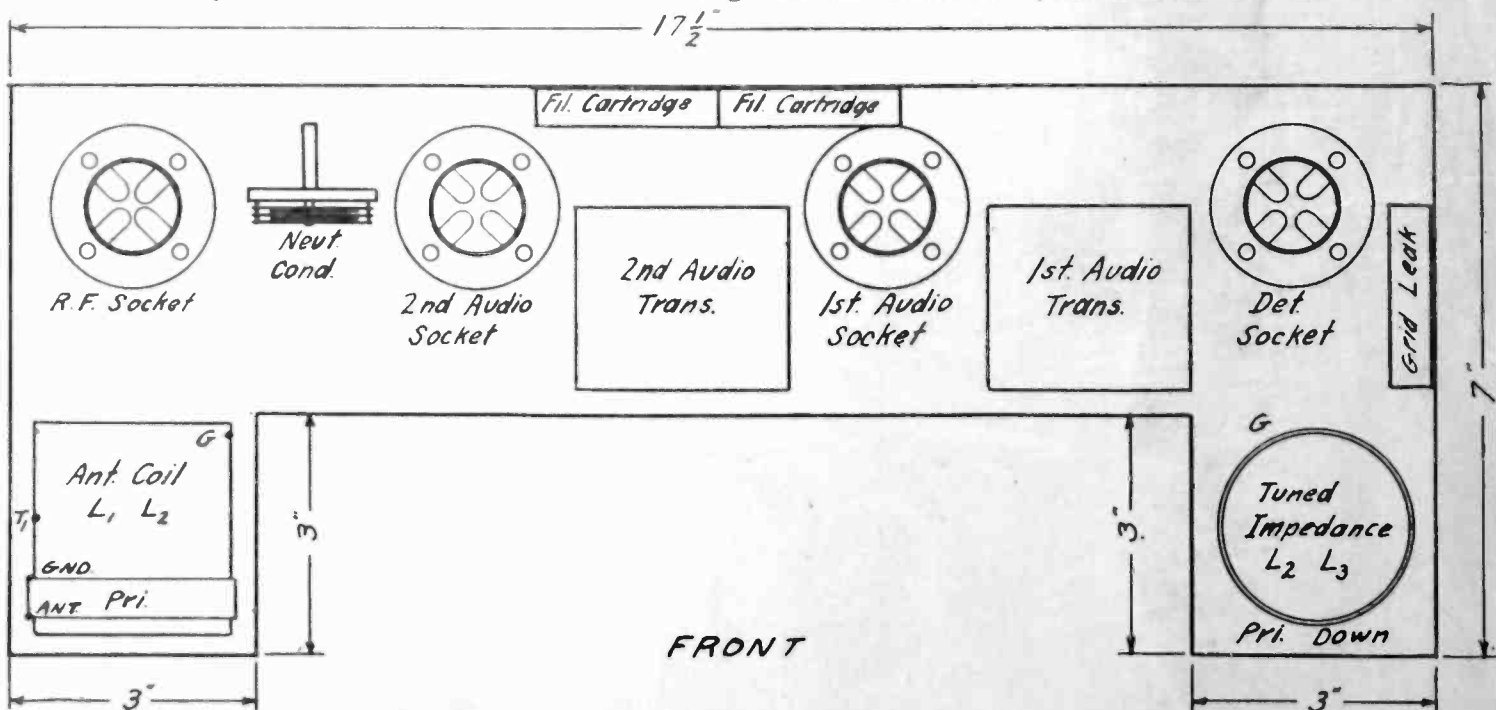
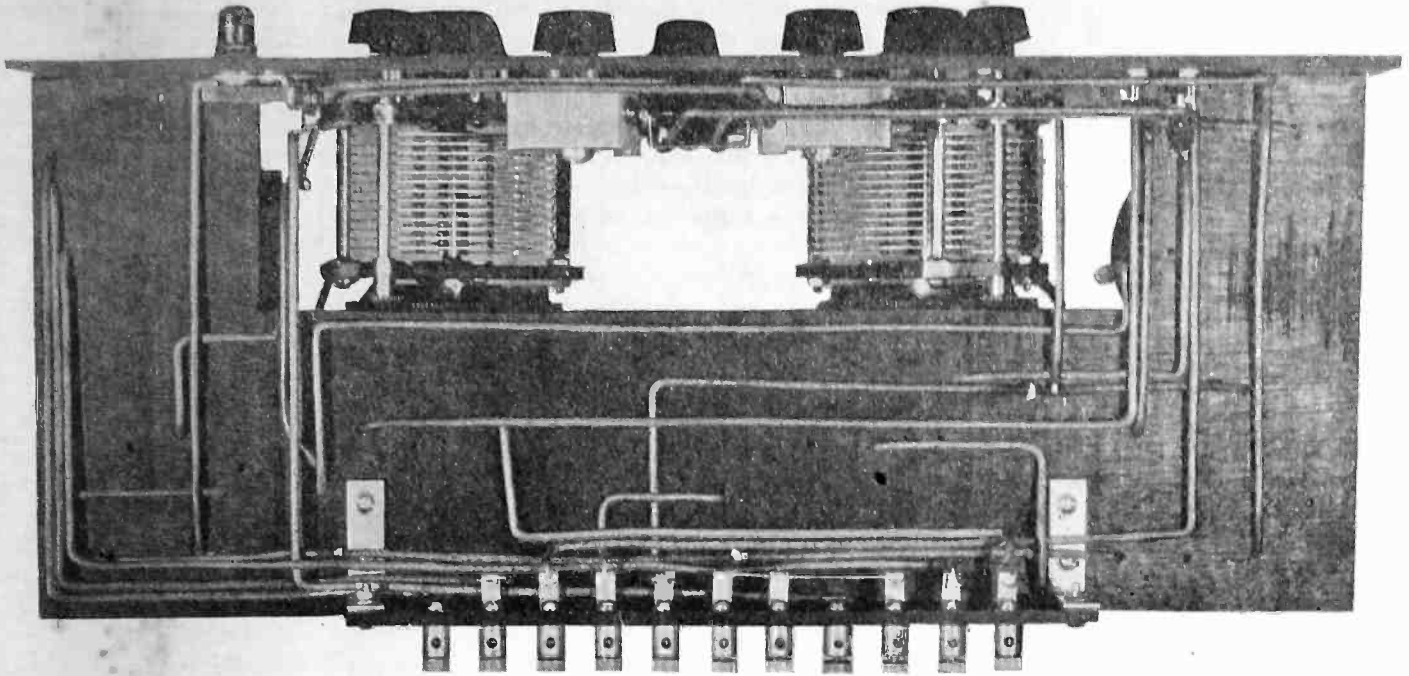

Fig. 4. Baseboard Layout of Parts.



Wiring Layout Under Baseboard.

In wiring the receiver the greater part of the *A*, *B* and *C* battery leads may be run under the baseboard. Leads carrying radio frequency should be wired in air above the baseboard.

No provision is made for the use of a single stage of audio by means of jacks. Instead the rheostat *R*₁ controlling the filament of the r. f. tube is used as a very effective volume control. This greatly simplifies the problem for the inexperienced constructor.

After the receiver has been completed, if it fails to regenerate, reverse the connections to the fixed tickler *L*₄. It will be necessary to accustom oneself to the use of the variable resistor *R*₃ as a regeneration control. When this is set so that the minimum of resistance is included across the tickler *L*₄ the receiver will not only fail to oscillate, because of the absorption in *R*₃, but *L*₄ will have the effect of so many short circuited turns in close inductive relation to *L*₃. Under these conditions the receiver will be extremely insensitive, so that it is necessary to keep resistance *R*₃ somewhere near the point where the receiver oscillates when tuning. There is no objection to making the detector tube actually oscillate, picking up the station by the squeal, since, if the r. f. tube is properly balanced by means of the small condenser *C*₂, the receiver cannot radiate.

In order to neutralize the receiver (and this should be done very carefully) cause the detector tube to oscillate by advancing *R*₃ toward some high resistance value. Then set the tuning condenser *C*₃ at such a point that the squeal of some station is heard at approximately half dial setting. Now swing condenser *C*₁ back and forth through the resonance point, observing carefully whether the frequency of the squeal is varied. If the tone of the squeal is altered at all by the motion of *C*₁ adjust *C*₂ until no

change in pitch can be detected as *C*₁ is moved up and down the scale. The intensity but not the pitch of the squeal should be varied by *C*₁ when the receiver is properly balanced.

Due to its great sensitivity the receiver will work well with a small antenna, but for best results an antenna 100 feet long, including lead-in and ground lead is recommended. With a large antenna, selectivity is better when either of the two substitute antenna coupling arrangements shown in Fig. 1 are used as illustrated by the dotted lines. A .0001 mfd. fixed condenser in series

THIS circuit readily adapts itself to operation in connection with the *ABC* eliminator described in December 1925 RADIO. Fig. 6 shows the method of wiring the filament and grid circuits of the four tube set so that the filament, plate and grid voltages are supplied from a rectifier system, which is shown at the bottom of the diagram.

Those who have read the article on the *ABC* eliminator will not find it difficult to follow out the circuit wiring, but it is well to explain for the benefit of those to whom the arrangement is unfamiliar, that the output of the Raytheon

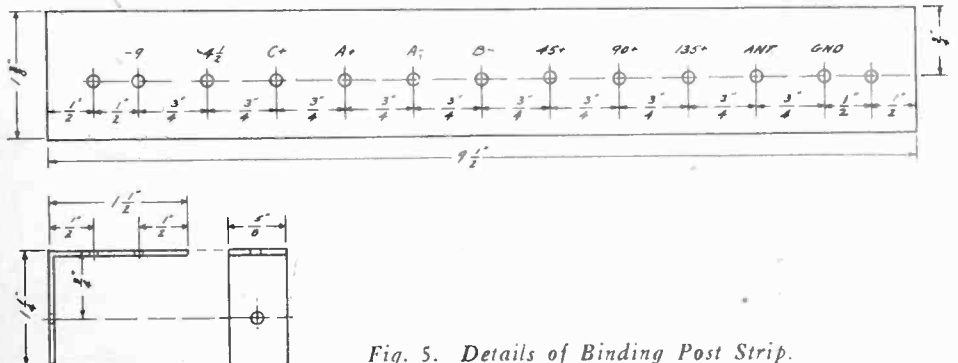

Fig. 5. Details of Binding Post Strip.

with the antenna, connected to the antenna post of the receiver or directly to the grid of the r. f. amplifier, may give slightly better results. This is best determined by experiment under the particular conditions of installation.

The 30 ohm rheostats used on the r. f. tube and the detector will take care of either UX 201-A or UX 199 tubes. The proper filament control cartridge for the tube used should be inserted in the filament leads of the first and second audio stages. Filament control cartridges for the UX-112 and UX-120 tubes, for use in the last stage are just now appearing on the market.

rectifier unit, after being smoothed into pure d. c. in the filter system, is approximately 140 volts, 60 milliamperes. This output is fed through a set of resistances consisting of two 1500 ohm Federal No. 25 potentiometers, the r. f., detector and first audio tube filaments, and two 25 ohms resistances, so that the load across the rectifier system is always approximately 3200 ohms.

The first three tubes in the set must be of the 199 variety, having a filament requiring 60 milliamperes at 3 volts, and with the filaments all wired in series. Between the a. f. amplifier and the r. f. tube is placed a resistance of 25 ohms,

obtainable from a Cutler-Hammer adjustable 30 ohm resistance unit, and a similar 25 ohm resistance should be connected between the detector and r. f. tube filaments. This enables the grids of the r. f. and 1st a. f. tubes to have a negative potential of $4\frac{1}{2}$ volts with respect to their filaments, with 90 volts plate, the C voltages for these two tubes being obtained by the voltage drop across one of the other tubes in the circuit, which is 3 volts, plus the $1\frac{1}{2}$ volt drop across a 25 ohm resistance, making a total of $4\frac{1}{2}$ volts.

The slider of one of the 1500 ohm potentiometers is used to take off the 45 volt tap for the detector tube, and the 90 volt tap for the r. f. and a. f. amplifiers is taken out between the two potentiometers. A UX-112 tube may be used in the last audio stage by utilizing the 7.5 volt winding provided with the power transformer, and inserting a 5 ohm resistance to limit the current to .5 amperes at 5 volts. An ordinary 6 ohm rheostat set at nearly maximum resistance will do. The power tube obtains 9 volts negative grid potential by means of the voltage drop across the r. f. and detector tubes and associated 25 ohm resistances, and the 140 volt B tap for the power tube is obtained from the slider of the 1500 ohm potentiometer nearest the rectifier system.

A millimeter having a 0-100 scale is a handy thing to have when adjusting the system, placing it in the positive lead between the filter and the potentiometers. After the current in this lead

is adjusted to approximately 63 milliamperes, it can be removed from the circuit. Due to the fact that the filament current in the 1st a. f. tube will be less than 63 milliamperes by an amount equal to the plate current of all three 199 tubes, which will amount to between 3 and 4 milliamperes, it is necessary to raise the total filament current to 3 milliamperes above the normal 60, so that the 1st a. f. tube will receive its rated supply. The r. f. tube will then receive approximately 61 milliamperes, which will do it no harm, and the detector tube the full 63 milliamperes.

As the additional current might in time reduce the life of the detector tube, it should be shunted by a General Radio 500 ohm tube protective resistance to by-pass the extra current. As an actual matter of fact, the total current can be adjusted to 60 milliamperes, the 500 ohm resistance omitted, and the 1st a. f. tube operated at 57 milliamperes, as it is understood from statements made by the tube manufacturers that the type 199 tube can be operated at currents as low as 54 milliamperes without loss of efficiency. From the standpoint of tube life, the latter arrangement would then be preferable, but the constructor can use his own judgment.

By-pass condensers of .5 mfd. each should shunt the B voltage taps for all tubes, as otherwise the circuit will howl at some audio frequency. Should a high frequency howl occur in the r. f. stage, due to the insertion of 75 ohms resistance in the grid circuit in order to obtain C

voltage for the r. f. tube, a by-pass condenser of .006 mfd. as shown in Fig. 6 will help cure the trouble.

In view of the fact that the source of primary power varies from 105 to 125 volts, depending upon the distance from the nearest pole transformer and the load on the circuit, there may be instances with 105 volts from the line where the total current delivered by the Raytheon tube, with the standard power transformers now available, will be considerably below 60 milliamperes at 150 volts. In this case, it will be necessary to cut out part of the fixed resistance in the positive lead, until the proper current is obtained. One instance was recently observed where the line voltage was slightly under 110, and the maximum permissible voltage from the rectifier, with 60 milliamperes flowing, was 115 volts. Under such circumstances, the UX-112 tube should not be supplied with more than 6 volts negative grid potential, for satisfactory operation.

An alternative regeneration control in the detector plate circuit is not shown in the circuit diagram, but may be added by removing the 50,000 ohm shunt potentiometer and placing it in series between the primary of the first audio frequency transformer and the tickler coil. It should be shunted with a .5 mfd. by-pass condenser in order to properly pass the audio and radio frequencies around the high resistance. If the shunt system of control causes the tube to regenerate with a "plop," and the changing of the grid

(Continued on Page 46)

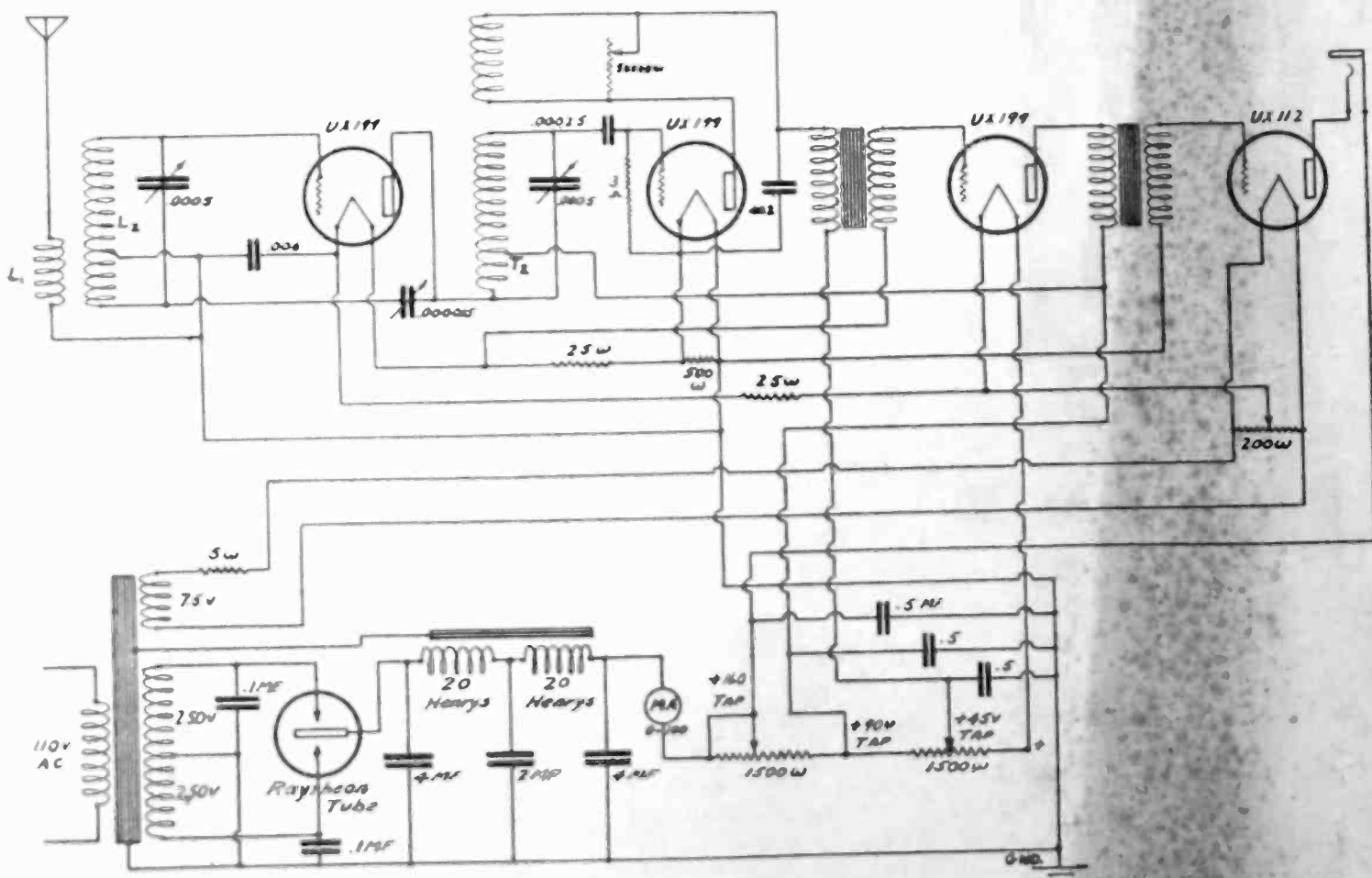

Fig. 6. Circuit Diagram for Use With ABC Eliminator.

A 1926 All-Wave Regenerator

A Flexible One-Dial Regenerative Receiver Capable of Giving Fine Tone Quality

By *McMurdo Silver*

THE last ten years have seen the rise, fall and decline of the simple regenerative receiver in public favor, but strangely enough, this system, when the last sad rites were about to be said over its supposedly defunct form, became gradually imbued with new life and is now well on the road, not merely to recovery, but to enjoy at least in a measure, a certain amount of its former prestige.

It has been fairly conclusively demonstrated that a good regenerative receiver on wavelengths below 200 meters is about as efficient a set as is required, for the transmission efficiency of even low powers at high frequencies is very great. In another sphere the regenerator seems to be regaining its position slowly—that of reception in rural localities. Where a short time ago the

LIST OF PARTS

- 1 .00035 mfd. SLF Condenser.
- 3 Resisto-Couplers—Daven, Brach, Electrad.
- 1 6 ohm filament rheostat.
- 1 inductance coil—190-550 meters—Silver 110A.
- 1 inductance coil mounting—Silver 515.
- 1 .5 mfd. bypass condenser.
- 4 UX type sockets.
- 3 .1 megohm grid leaks.
- 2 .5 megohm grid leaks.
- 1 1 megohm grid leak.
- 1 .002 mfd. mica condenser.
- 1 1-spring jack—Carter, Pacont.
- 1 2-spring jack—Carter, Pacont.
- 1 Filament switch.
- 1 Vernier Dial.
- 1 7x18x $\frac{1}{4}$ in. bakelite panel.
- 1 7x17x $\frac{1}{2}$ in. oak baseboard.
- 12 No. 6 R. H., N. P. Brass wood-screws, $\frac{3}{4}$ in.
- 2 No. 6 R. H., N. P. Brass wood-screws, $\frac{1}{2}$ in.
- 5 Length bus bar wire, 12 feet total length.
- 1 5 lead color cable for battery wiring—Belden.

least listen for the longer wave European stations. Since the prospective builder will no doubt be more interested in radiocast reception than in amateur work, to which such a receiver is nevertheless admirably adapted, the audio amplifier used should be capable of reproducing with a minimum of distortion all frequencies required for satisfactory speech and music transmission, assuming a good loud speaker to be used.

Such a receiver is illustrated in the accompanying pictures. The simplicity of the design is evident at first glance, for all unnecessary controls have been eliminated from the panel, with the questionable exception of the rheostat. The panel upon which the controls are mounted is a standard 7x18 size, of bakelite. The large central dial is the wavelength control, while the smaller knob to the left is the regeneration condenser. To the right is the rheostat controlling all tubes, and in the extreme right corner the on-off switch and output jacks.

Before considering the layout of the receiver, some attention should be given to the circuit shown in Fig. 1. This consists of a standard feed-back regenerative detector followed by three stages of resistance coupled audio amplification. The detector tube functions with a negative grid bias for rectification rather than the conventional grid condenser and leak. The reason for this is primarily one of convenience, for while theoretically a grid-biased detector provides lower circuit resistance with consequently greater selectivity, in actual practice this method of rectification produces the same resultant signal as a grid-condenser-leak rectifier and is accompanied by less noise. However, the chance of trouble with the leak and condenser is eliminated and the system consequent-

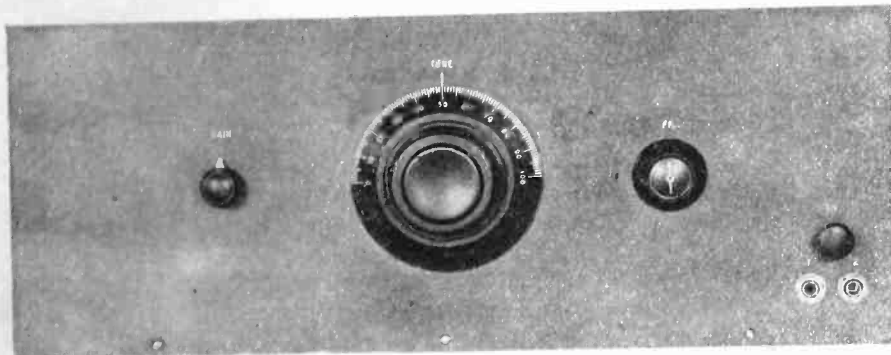

Panel View Showing One Dial Control

farmer desirous of receiving distant stations felt it necessary to employ an expensive receiver of the tuned-radio frequency type, today finds the apportionment of broadcasting stations throughout the country such that there are few isolated areas where a good regenerator will not serve to bring in satisfactorily most of the three to seven hundred mile distant stations.

The popular regenerator of several years ago with a pair of massive variometers, a variocoupler and a miscellaneous agglomeration of dials and switches is now obsolete.

In place of the many-control regenerator formerly used, the trend in design today is to the utmost in simplicity—not necessarily by the elimination of valuable variable controls, but rather by providing means of adjusting certain constants which of late have been discovered to be non-critical to the particular operating condition to be encountered, yet placing on the instrument panel only those few critical controls necessary for the operation of the set once it has been adjusted to individual local conditions.

Further, since one of the most important future spheres of the regenerator is in short wave reception, a practical receiver should be capable not only of covering the regular radiocast channels but also of tuning down to the lowest waves where radiocasting is in use. It should also be capable of having its wavelength range extended above the regular radiocast band so that the operator may at

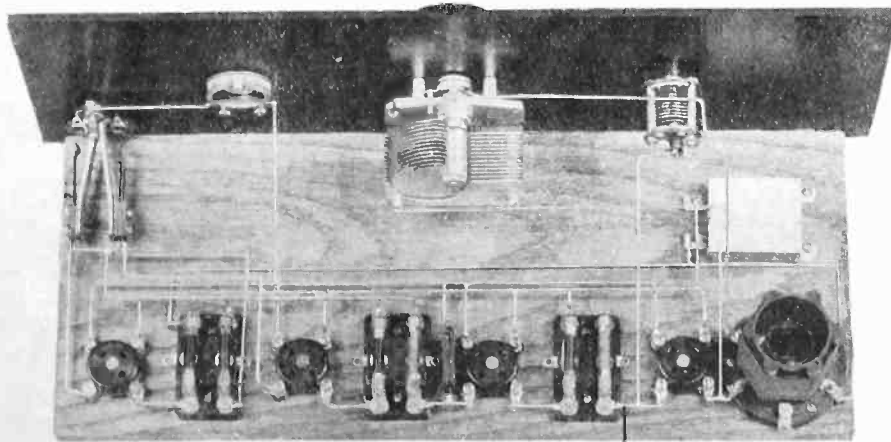

Assembly of Baseboard and Panel Apparatus.

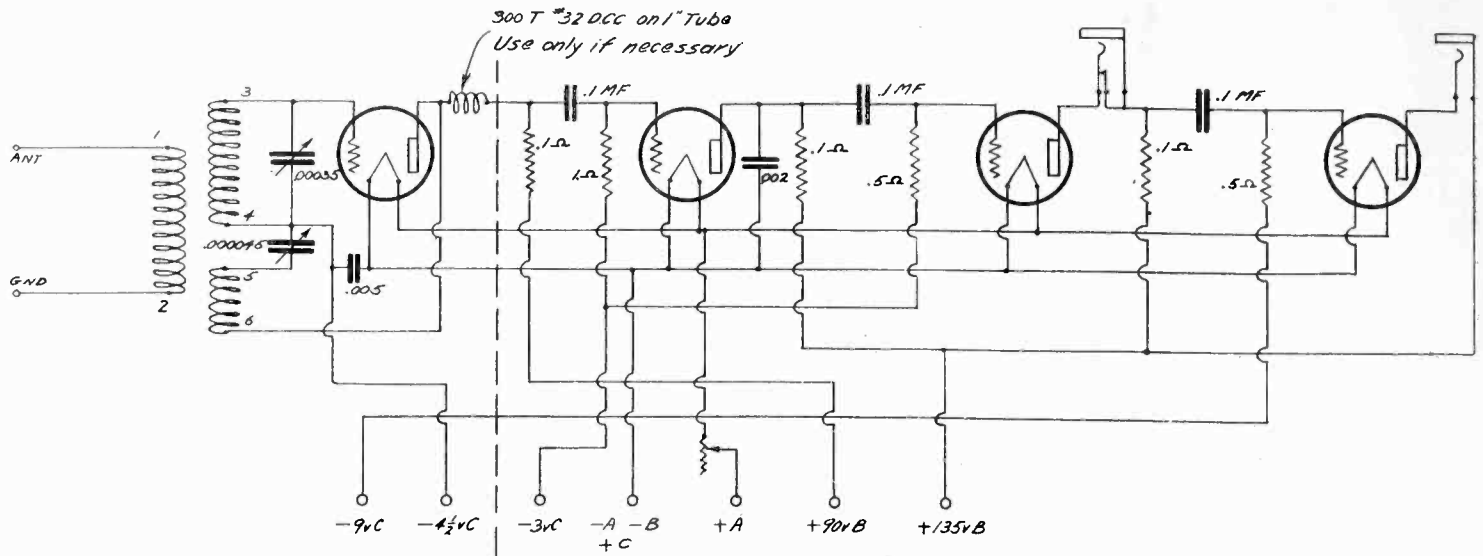
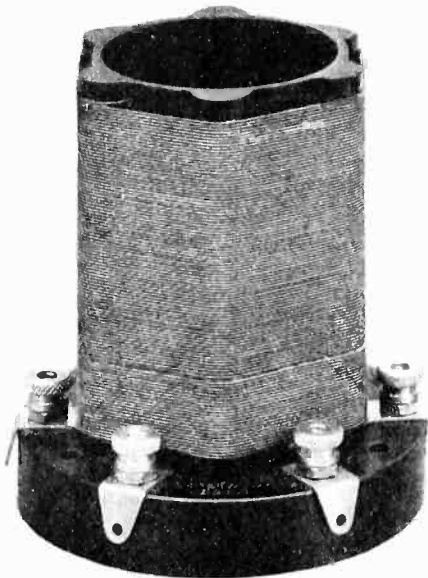

Fig. 1. Wiring Diagram of Regenerator.

ly simplified, since the same "C" battery is used for both audio amplifier and detector.

A straight-line-frequency condenser of 350 m. m. f. capacity is used for tuning, this size not being too small for good operation on the longer waves, nor is it so large as to make tuning unduly difficult on the lower waves. This can be rendered extremely easy through the use of a good standard vernier dial, which features the concealed scale rapidly becoming popular. The regeneration condenser—a small standard midget—is so arranged that its rotor is at ground potential.

The coil system is of a new interchangeable type, with winding forms of low-loss moulded bakelite, 4 in. long. Each form, which is identical to every other, is arranged with six raised ribs on its surface so that the windings touch the periphery of the form only at six places—on the six ridges. The bottom of each form consists of a reinforced ring carrying six contacts to which the winding ends are soldered, with the exception of two, which make contact with springs inside the form which hold a small adjustable rotor, which may be



Inductance Coil Unit Arranged for Plug Mounting.

removed if desired. The coils plug into a special six-contact socket provided for them.

This provides not only a low-loss arrangement due to a favorable form factor and inductance design, but a very flexible one as well, for to shift the en-

tire wave range of the receiver it is merely necessary to pull out one coil and plug in another—an operation consuming about 10 seconds. Since no switching arrangement is employed other than this, and as consequently no dead coils are in the receiver when not in use, the overall efficiency of the arrangement is quite high, particularly at short waves.

The fact that the coil forms are provided with adjustable rotors used in the antenna circuit permits of adjustments which will afford greatest efficiency for each wavelength range to be covered. Further, it is possible to loosen up the coupling so that the radiating effects of the set may be reduced, if not entirely eliminated so far as other neighboring receivers are concerned in case the regeneration control is advanced too far.

The audio amplifier is of the conventional three stage resistance type using constants suited to standard tubes available. The coupling condensers—.1 mf.—together with the grid leaks have a time constant such that it will not interfere with the passage of the entire frequency range used in speech and music transmission. The condensers

(Continued on Page 48)

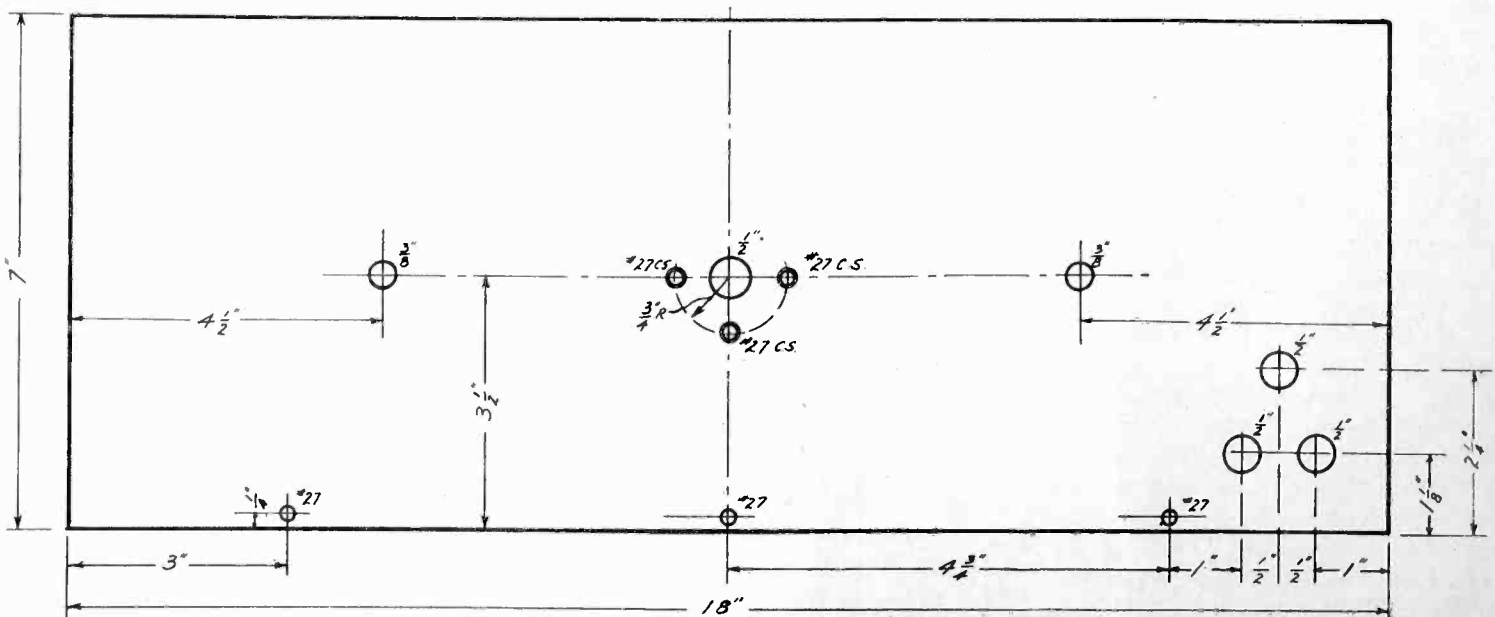

Fig. 2. Panel Drilling Template.

Ye Art of Soldering

By Kirk B. Morcross

P-s-s-T! Sounds peppy and it generally produces a nice shiny point, that's probably the reason we do it. Do what? Stick the tip of the hot soldering iron (erroneously called soldering copper) into a tin of soldering paste. This is a sure-fire method of accomplishing certain definite results, to wit: (1) taking life out of soldering paste and putting in dirt and solder; (2) filling room and eyes with smoke; (3) eliciting comments from wife or mother.

True, there are plenty of good jobs of soldering done by this method of attack, but it's quite unnecessary. A tinsmith perched on the edge of a roof finds it desirable to make plenty of fizzy noises. The leak-proofness of the drain pipe he is repairing is given by the formula:

$$L_p = (Z-z-z)^2 + Q(D),$$

where Z-z-z = fizzes produced,

D = density of resulting smoke, and Q is a consonant.

Being yards above the ground he is secure from woman-made interference. But fixing a crack in a drain pipe while advantageously located for broadcasting smoke and noise and for receiving a fresh supply of air is by no means to be compared to the indoor sport of soldering wires inside your radio cabinet,—no sir!

I hear you say, "I'll do my soldering the way I doggone please and get just as good results as anybody." Fair enough, but suppose you could get equal results with less trouble and waste. Suppose, for example, you could make just as seaworthy a radio set by easing up on soldering paste. Would you do it? Of course you would!

So there's a good start: we'll stop the soldering paste manufacturers from running night shifts. In the fiscal year ending Dec. 31, 1924, 1,998,637 tins of soldering paste were sold for radio use; 99 44/100 per cent of them were pure waste. They would never have been needed if radio fans had properly cared for the preceding year's supply. Instead they sent part of it up in smoke, automatically replacing the loss with dirt from the soldering iron and the next thing on the program they had a supply of bum soldering paste on hand to consign to the garbage.

And as to solder, in the same year, 1924, there were 1122 tons—but I'm getting ahead of my story. Anyhow don't consider these remarks as personal but resolve to read the rest of this article and see if you don't pick up some helpful information. From now on the text will be developed systematically and the sermon will be kept reasonably short.

AUTHOR'S NOTE: Nearly everyone knows that heat travels with great vivacity through copper. In fact every radio fan has demonstrated that it can travel through two inches of "bus bar" wire a trifle quicker than a soldered joint can set. For the benefit of new recruits to the army of BCL's I suggest the following experiment which is fairly convincing: hold wire to be soldered between thumb and finger of one hand and touch the hot soldering iron to 'tother end of wire where you think you are going to make a connection. Hold the wire steady until the solder hardens. (Just try to hold it.)

by sliding the tip of the iron along the joint. As a matter of fact the solder will flow of its own accord only when it gets good and ready. And it is always ready if the joint is clean. Trying to make it go where it doesn't want to, only makes matters worse. It is like arguing with a barber. Wait patiently until the solder runs into the space where it belongs, remove the iron and be careful not to jar anything until the solder sets.

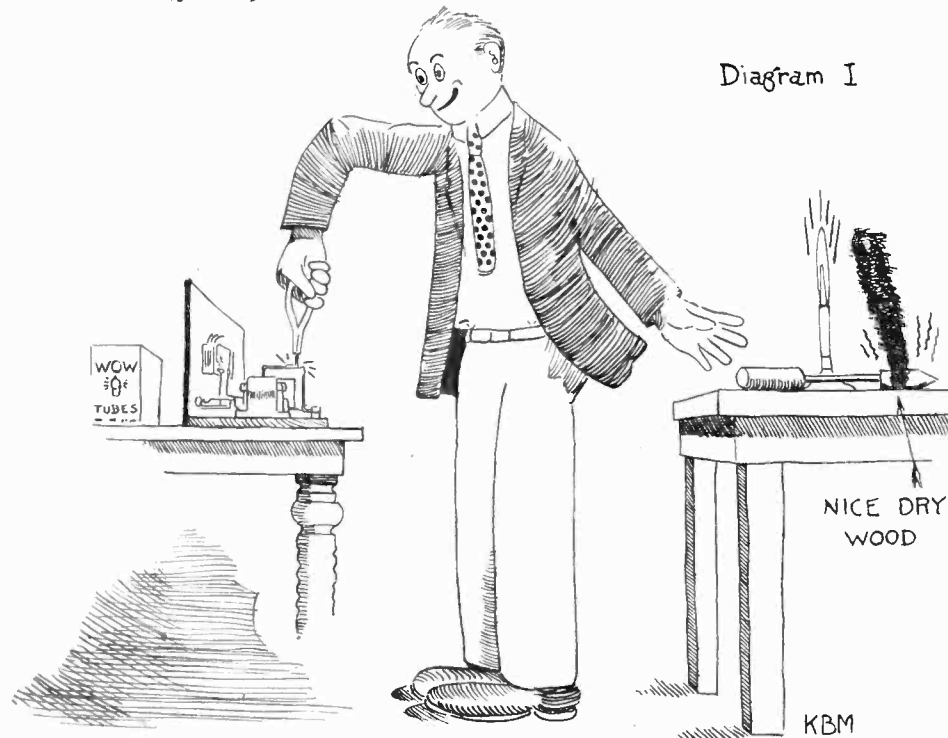

Diagram I

A-h-h-h! I see you turning over the pages to see where it ends!

Returning to the text, you don't need to develop a hammer and tongs style to make a blue ribbon job of soldering on your receiving set. If the circuit court got out an injunction requiring a description of the operation in a nut shell it would read thus: "Be stingy with the soldering paste and solder."

When you remove the iron from the fire, just give it a few swipes with a clean rag and obtain a beautiful shiny tip ready for business—no smoke, no odor. The rag may best be obtained from a clothes closet when no one is looking. It can range from an apron to—well, most anything.

Apply a small amount of soldering paste to the joint to be soldered and a volumetrically¹ equivalent amount of solder to the tip of the iron. Touch the iron to the highest part of the joint so the solder won't have to run up hill, and hold it there until the solder decides to investigate. This is the crucial part of the whole process; one's natural tendency is to try to push the solder in place

If necessary hold the wire perfectly still with a pair of pliers.

One thing more, remember that the iron is still hot, even though you are temporarily through with it. Hence don't lay it down on the work bench unless it has an asbestos top or unless you want to demonstrate the charring effect upon wood. (See Diagram 1). The writer has absent-mindedly investigated this phenomenon so there is nothing in it for you as a matter of research.

This process produces a joint with a batting average of .999. However, if you are satisfied with .700 or less you will find it easy to attain by disregarding these precautions.

Proper temperature of the iron is most important. I suppose one could invent a thermometer to indicate the correct heat but it would not be any more necessary than static to a radio program. Hold the soldering iron near one cheek and if it burns you turn the other. After a little practice you won't get it too close and you can judge the correct temperature second only to a certified thermometer.

How about the source of heat? For

¹ See Bunk and Wagnall's.

this most any kind of flame will do, provided it has the following specifications: (1) clean; (2) clean; (3) clean. You can't perform a successful operation on a radio circuit with an iron heated in a dirty flame; infection may set in, causing funny noises in the loud speaker. The flame may be a Bunsen burner, a blow torch, or the burner of a gas range.

The soldering copper should have an inquisitive nose and it should be big enough to get the heat where you want it. If you go in for DX soldering see that the iron weighs four ounces for each ten feet it has to be transported. I tried DX soldering once (it was my first and last attempt) in violation of this rule. See Diagram II. It was at

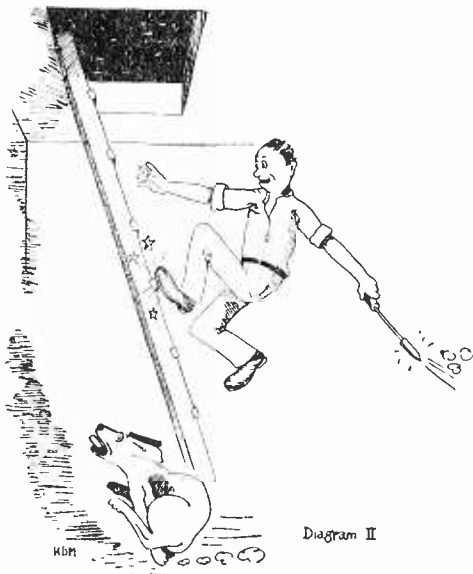

the beginning of my radio career, A. D. 1909. My radio set—I mean “wireless” set—was located in a closet on the second floor of the house. Directly above this was a trap door leading into the attic. I ran my ground wire up through this door and wrapped it around a sand papered gas pipe 33 times. But I was not satisfied; I wanted to solder it, to be conscience free. The nearest source of heat was the gas range in the kitchen. I used a one-pound soldering iron, 792 cubic feet of gas, and wore holes in my shoes racing up those steps, thence up a ladder and through the trap-door into the attic. The lengthening shadows of late afternoon showed that I had succeeded in melting some solder around the connection since the heat did not soak away from the joint quite as fast as I could bring it up from the kitchen. I had as good a connection, after applying the solder, as before.

If your work is right by the source of heat you may find that a small soldering iron is best. It has one definite advantage; it will get hot while you watch it, whereas a large soldering iron never warms up in less than 32 minutes flat while chaperoned. On the other hand if you turn your back on it, it develops a red heat in two minutes and three seconds and you have a job of retinning on your hands.

As to retinning, there's no more need

of spoiling your soldering paste than when soldering. Heat the iron to dull red, clean the tip with a file, apply some soldering paste and then offer the sizzling point a bit of solder. Ninety-nine times out of a hundred it will swallow it greedily.

Although over 99 per cent of the soldering paste goes into the garbage can, the major portion of that which is used runs along the wires under the soldered joints and goes to roost there or it soaks into the insulation on the coils. Here a milligram of prevention is worth a kilogram of cure. Most of the joints to be soldered in a radio set are tin or in any case they are bright and clean. Hence it isn't necessary to supply them with an overdose of paste. Also wipe the joint clean just as soon as the solder sets.

In 1924 there were 1122.1 tons of solder sold to radio fans and 122.6 tons of it has settled down—literally and figuratively speaking—and is living comfortably in the bottoms of a thousand or so battalions of soldering paste tins. The rest of it has not all been accounted for but estimates indicate that there are not less than 728 tons physically qualified for active service. Of this amount approximately 234.67 tons will never answer the roll call. It has either been swept up with bakelite shavings, binding posts, battery clips, beetles, condenser plates and other rubbish, or it is permanently hibernating in a box of radio curios or in the darkest corner of the closet shelf. The few remaining tons are evenly distributed in radio sets from Maine to California; 33 tons of it hang from soldered joints, stalactite fashion, 7.3 tons has investigated the insulation on coils and about a dozen tons has run in between the terminal springs on jacks, where it does not begin to take an active interest in its talent for short circuiting things until company arrives all set to hear the “radio” perform. Moral: don't use so much solder that it has to migrate to find living quarters.

Every radio set which shows by inspection that less than 2 per cent of the solder in its insides is doing useful work (short circuits not counted) should be placed in the service station. The overhauling process will return a lot of solder to the market and it will result in a radio set giving more miles per concert.

² Reader fill in with fountain pen.

The Australian Commonwealth Government intend altering the regulations governing the use of radio and the experimenters are taking the opportunity of placing before those responsible, a strong claim that bands of frequencies above 3,000 kilocycles should be granted to them for experimental research: it is hoped that a series of bands similar to those in use by Americans will be granted.

THE TIME TOTALER

By KEITH LABAR

NO one but a ham knows the exquisite joy of a well metered transmitter. With meters we know how much the tubes are overloaded and can brag about the five amperes radiation to less fortunately afflicted fellow hams.

One element that might have been metered is totally neglected. We measure volts, amperes, and watts but we forget the fourth dimension, time. How can the relative efficiency of two stations be compared if the total time the stations were in operation is not taken into account? The station that wears the ether thin will have more of a stack of Uncle Sam's best postals than the quieter station of perhaps the same power.

The Time Totaler will keep a record for you of the time the set was in operation. It consists of a clock to measure time, a Veeder counter of the direct drive type, registering ten for each revolution, to record revolutions of the minute hand, and an electromagnet to connect the counter to the clock through two friction wheels when the set is on.

The small wheels are 1½ in. in diameter and may be of any convenient material with a rubber band around the edge to insure positive contact. One wheel is attached to the counter and the other is driven continuously by the clock. If the clock is used also for the purpose of telling when to call it a night this

(Continued on Page 60)

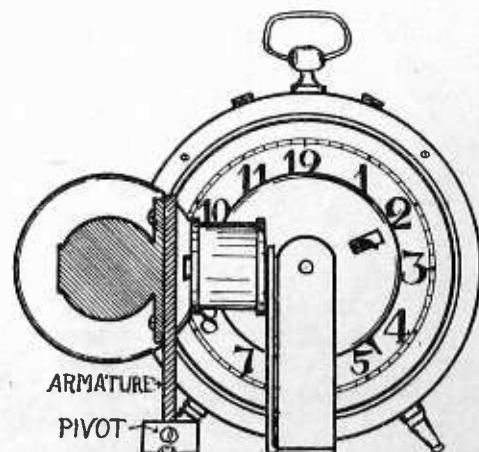
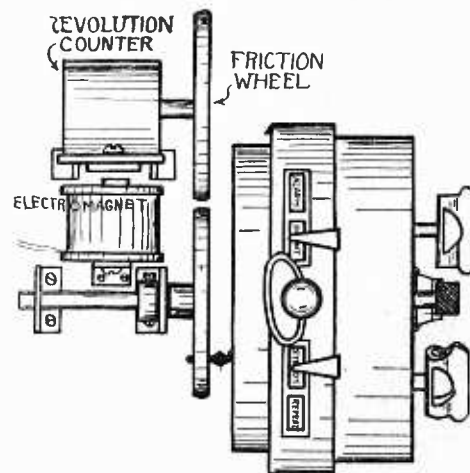

The Time Totaler.

An Efficient One-Tube Set

The Second in the Series Started in December Radio

By E. M. Sargent

HAVING built the ultra-selective crystal set described in December, 1925, RADIO, you are now probably ready to substitute a vacuum tube for the crystal detector. This can easily be done with the former set as the basis by removing the crystal and adding a few parts, or the one-tube set can be made as the initial unit by those who have not made the crystal set.

A comparison of the materials required for the one-tube set with those required for the crystal shows that the only discarded apparatus is the crystal detector, which may be used in a future reflex set. Aside from the storage battery the new parts are inexpensive. The writer recommends the use of the storage battery tube.

The crystal detector is removed from the panel and a three plate variable condenser put in its place. A small copper shield should be put on the panel under this condenser, this shield being grounded. Care should be taken that none of the screws in the condenser are allowed to touch this shield, and it will probably be best to use two or three washers as bushings between the panel and the condenser to make sure that no undesired contact is made.

A rheostat is mounted in the lower right hand corner of the panel and the battery switch on the left hand side at about the center, as per the template, which is drawn for the apparatus specified. Slight changes may be necessary if other equipment is used. The baseboard layout looks to the future and the parts are so placed that they will not have to be moved when the parts are added later for the larger sets. The writer therefore, recommends that this layout be very carefully followed. It is advisable to use a good quality, non-microphonic

LIST OF PARTS

New

- 1 3-plate condenser (B. T.)
- 1 2-in. dial.
- 1 20 ohm rheostat (U. S. L.)
- 2 .0001 mfd. condenser (N. Y.).
- 1 .006 Meadon.
- 1 5 meg. grid leak (Daven).
- 1 vacuum tube socket (Remler).
- 3 Binding Posts (Eby).
- 1 filament switch (C. H.).
- 15 ft round bus wire.
- 2 lengths spaghetti.

From Crystal Set

- 1 input coil (des. in Dec. RADIO).
- 1 coupler (ditto).
- 2 variable condensers. (ditto).
- 1 battery clip and lead.
- 1 open crt. jack.
- 2 binding posts.
- Panel 7x10x3/16 in.
- Baseboard 3/4x7 3/4x15 in.
- Bakelite strip 3/16x3/4x9 in.
- 3 No. 6. wood screws F. H. 3/4 in. long.
- 4 ditto R. H.
- 2 1/2 in. angle brackets.
- 2 6/32x1/2 in. machine screws.
- 2 6/32 hex. nuts.

size. In fact, the writer has never been able to discover why .00025 mfd. should have been decided on as the proper size for a short wave grid condenser. The early experimenters used variable grid condensers for which the most efficient dial setting was about 15 degrees which corresponded to about .00005 mfd. capacity. Some of the earlier receivers held to this variable grid condenser idea, but it was discarded in favor of the fixed condenser, probably because inexperienced operators persisted in trying to tune in stations with this dial.

A variable grid condenser is not a necessity but it is a great advantage to use one of approximately the right capacity. Tests show that the best results are secured with .00005 mfd. and a 5 meg grid leak. Incidentally this grid leak

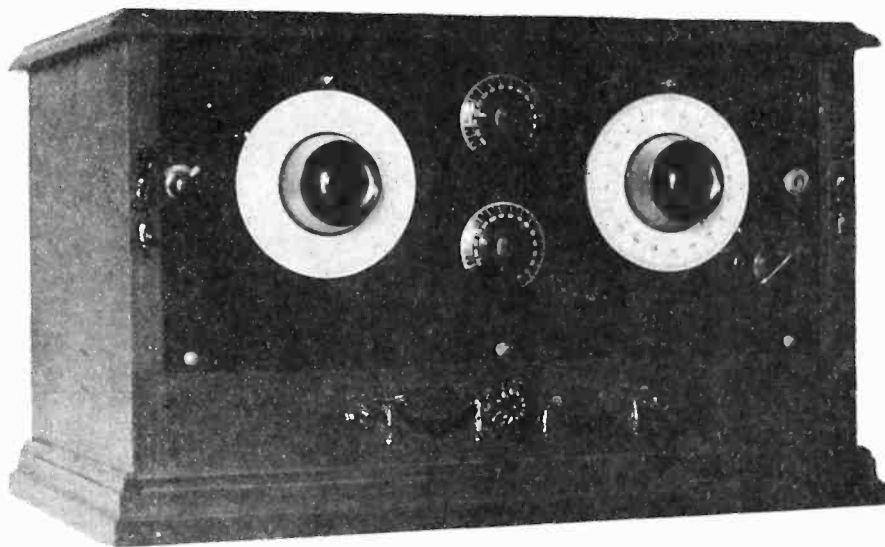

Panel View of One-Tube Regenerative Non-Radiating Receiver.

socket, like the Benjamin, in order to minimize tube noises.

The grid condenser represents somewhat of a departure from the accepted

should be of high quality and should not only have a 5 meg label pasted on it but should be tested and guaranteed to be somewhere in the neighborhood of 5 megohms. Grid condensers of the size mentioned are not obtainable in single units and can best be made by putting two .0001 condensers in series. The pictures of the complete set, the wiring diagram, list of material, and the template give all of the necessary information for constructing the set.

Although this set is regenerative, it is not one that will radiate and bother the neighbors. The three circuit arrangement between the antenna and the tube practically eliminates this radiation. The regeneration is accomplished by means of the three plate variable condenser, which is used exactly as if it were a tickler coil. The operator of this set will be pleasantly surprised by its selectivity, as

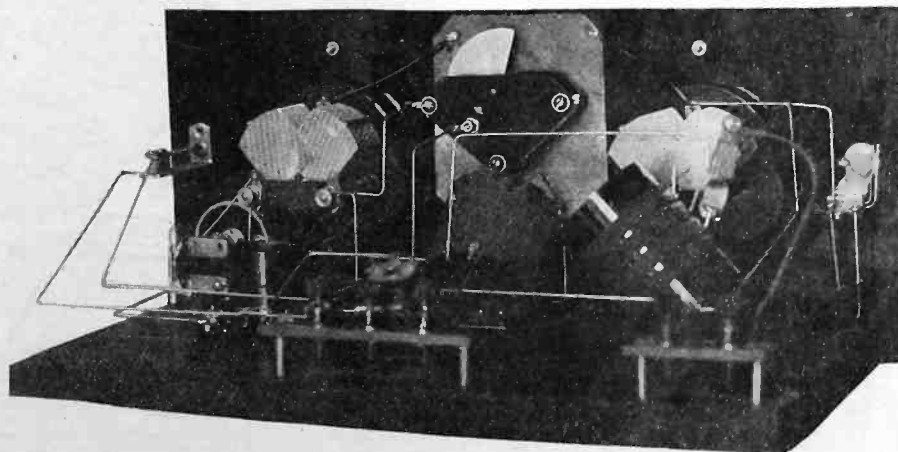

Rear View of Receiver Showing Placement of Parts.

it is almost as selective as the average five tube tuned radio frequency receiver.

The operation of the set is rather difficult unless the operator bears in mind the general layout of the set and what he is actually accomplishing by adjusting each dial. The coupling dial and the antenna taps are purely selectivity controls and should not, under any conditions, be used to adjust the wavelength. This does not mean that they will not affect the wavelength of the receiver. On the contrary, they sometimes have a very marked effect on the wavelength, but it is not the right way to tune the set and a much more efficient setting can be found by changing the wave with the two large condenser dials. Turn both of these dials at once, keeping them as near as possible on the resonant points.

For local reception, the three plate condenser can be set at zero but for the distant stations it should be brought up to the point of regeneration. The distance that can be received depends almost entirely upon local conditions and upon the weather. Suffice to say that the

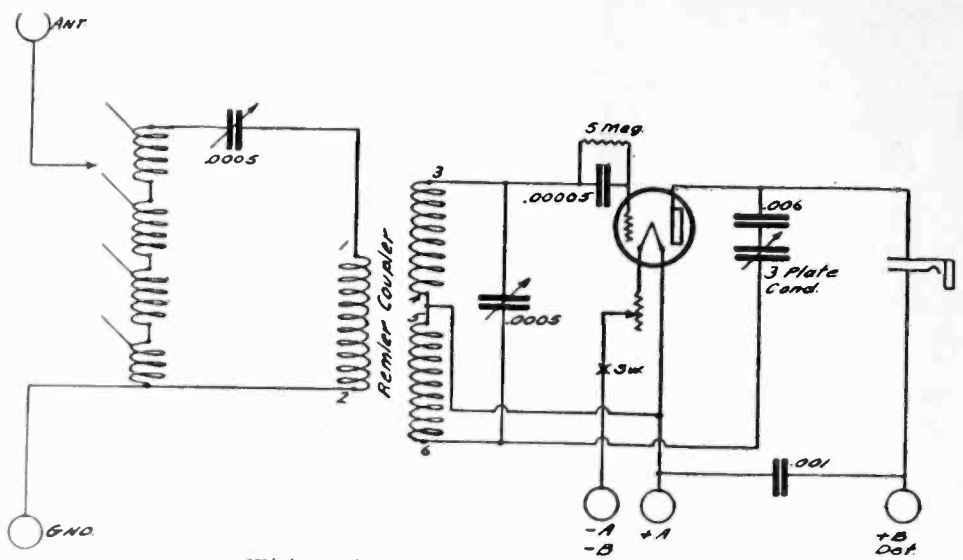

Wiring Diagram of Sargent Circuit No. 1.

set has the required selectivity to eliminate the locals and has the sensitivity to pick up weak signals. This is as far as the set designer can go towards assuring himself of distant reception and the balance is a matter of chance.

In the next issue of RADIO, the two tube set will be described in

detail. The writer would suggest, in order to avoid repetition, that the reader lay aside this and the preceding issue, because several of the parts, such as the input coil, are used in a great many of the later sets, and the instructions for building, as outlined in the first article, will not be repeated.

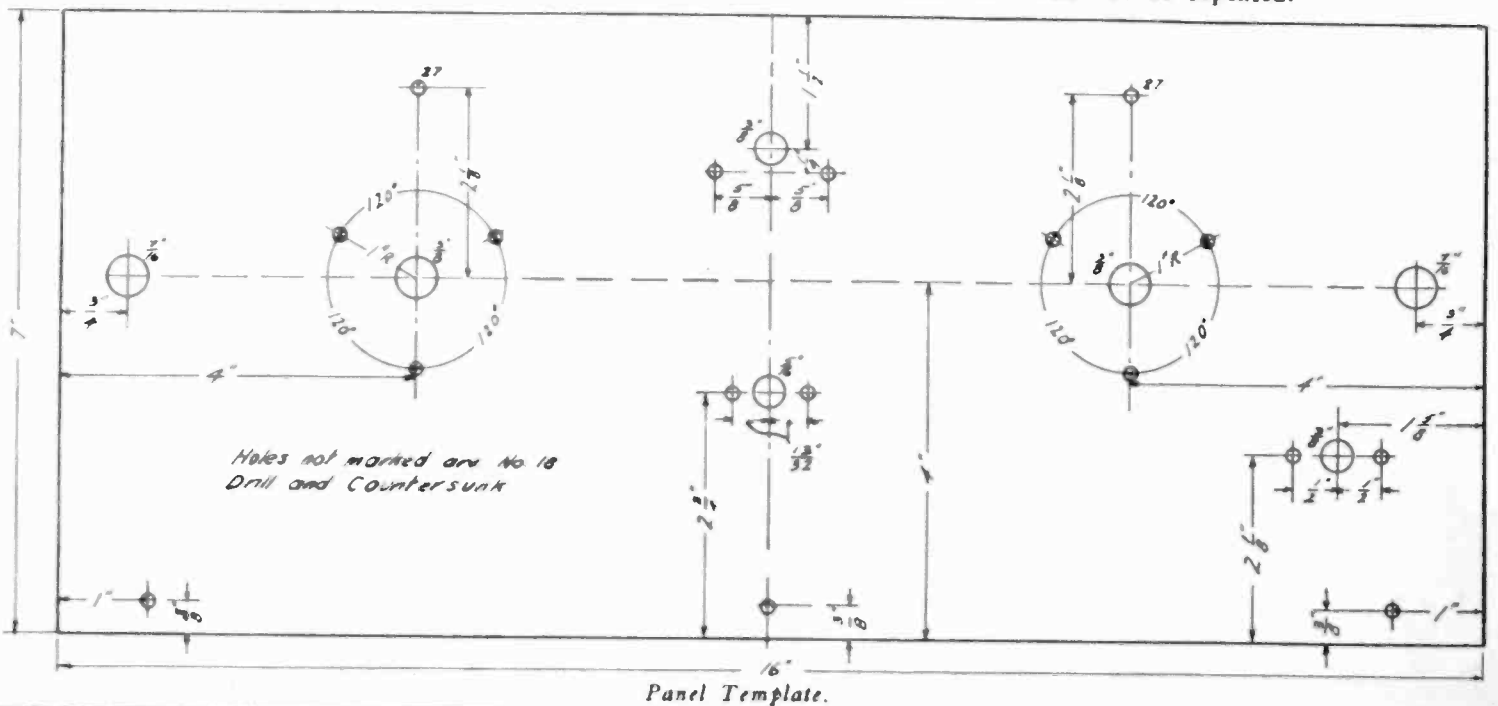

SHORT WAVE STATIONS

L.C.—LIMITED COMMERCIAL				L.P.—LIMITED PUBLIC				P.C.—GENERAL PUBLIC					
Class	Frequency Kilocycles	Wavelength Meters	STATION	Owner	Power (Watts)	Call	Class	Frequency Kilocycles	Wavelength Meters	STATION	Owner	Power (Watts)	Call
L.P.	13620	22	New Brunswick, N.J.	R.C.A.	40	KW WIK	L.C.	2142	140	Iron M'tain, Mich.	Ford Motor Co.	500	WDY
L.P.	8560	35.03	Rocky Point, N.Y.	R.C.A.	20	KW QO	L.C.	2142	140	Flint, Mich.	F. D. Fallain	500	WGF
L.P.	6970	43.02	New Brunswick, N.J.	R.C.A.	20	KW WIZ	L.C.	2142	140	Quanah, Tex.	Quanah Light & Ice Co.	250	KPG
L.C.	6814	44	Los Angeles, Calif.	Jay Peters	50	KZA	L.C.	2142	140	Lawton, Okla.	Southwestern Light & Power Co.	250	KPP
L.C.	6814	44	Portland, Calif.	Jay Peters	350	KZB	L.C.	2142	140	Portable-Okla., Tex.	Southwestern Light & Power Co.	100	KPK
L.C.	5996	50	Springfield, Mass.	Westinghouse E. & M. Co.	20	KW WBZ	L.C.	2142	140	Oklahoma City, Okla.	Southwestern Light & Power Co.	270	KPR
*L.P.	5820	51.5	Rocky Point, N.Y.	R.C.A.	20	KW WQN	L.C.	2142	140	Brownsville, Tex.	Rio Grande Radio Supply	10	KFWS
L.C.	5100	58.79	E. Pittsburgh, Pa.	Westinghouse E. & M. Co.	20	KW KDKA	L.C.	2142	140	San Benito, Tex.	Rio Grande Radio Supply	10	KFWR
L.C.	5082	59	Casper, Wyo.	Illinois Pipe Line Co.	500	KDC	L.C.	2142	140	Detroit, Mich.	Detroit Yacht Club	500	WDYC
L.C.	4400	68.4	Miami, Fla.	Florida Radio Tele. Co.	100	WRB	L.C.	2110	142	Charleroi, Pa.	West Penn. Power Co.	100	WJBF
*L.C.	4400	68.4	Pinecrest, Fla.	Florida Radio Tele. Co.	5	WRP	L.C.	2100	143	Baltimore, Md.	Board of Fire Commrs.	250	WEQ
L.P.	4052	74	New Brunswick, N.J.	R.C.A.	20	KW WIR	L.C.	2100	143	Washington, D.C.	Potomac Electric Power	50	WJX
L.P.	3331	90	Kabuku, Oahu	R.C.A.	20	KW KIO	L.C.	2100	143	Washington, D.C.	Potomac Electric Power	50	WJH
L.P.	3156	95	Balinas, Calif.	R.C.A.	20	KW KEL	L.C.	2050	146	Boston, Mass.	Boston Fire Dept.	5	WEY
L.P.	2910	103	Tuckerton, N.J.	R.C.A.	20	KW WGH	L.C.	2050	146	Dallas, Texas	Dallas Fire Dept.	100	KVP
L.C.	2188	137	Portville, Pa.	West Penn. Power Co.	100	WOY	L.C.	2050	146	Pysh, Wash.	Merrill & Ring Lumber Co.	5	KJA
L.C.	2188	137	Pottsville, Pa.	Pa. Power & Light Co.	500	WDS	L.C.	2050	146	Portable-Calif.	Russell Reed	50	KFZ
L.C.	2188	137	Wilsonville, Pa.	Pa. Power & Light Co.	200	WLF	L.C.	2050	146	Portable-Calif.	Russell Reed	50	KGZ
L.C.	2188	137	Frackville, Pa.	Pa. Power & Light Co.	200	WBI	L.C.	2050	146	Portable-Calif.	Pratt & Dutro	500	KYX
L.C.	2188	137	Williamsport, Pa.	Pa. Power & Light Co.	200	WPH	L.C.	2050	146	Portable-Calif.	Pratt & Dutro	500	KZI
L.C.	2188	137	Hazleton, Pa.	Pa. Power & Light Co.	100	WCJ	L.C.	2050	146	Calver City, Calif.	Cecil B. DeMille	50	KJU
L.C.	2188	137	Allentown, Pa.	Pa. Power & Light Co.	200	WHC	L.C.	2050	146	Los Angeles, Calif.	L.A. Co. Forestry Dept.	500	KYY
L.C.	2142	140	Dearborn, Mich.	Ford Motor Co.	500	WAV	L.C.	2050	146	Portable-Calif.	L.A. Co. Forestry Dept.	300	KFV

*Also on 54.5 and 57 meters. †Also on 143 meters, 1713 meters, 1875 meters. **Also on 1600 meters, 1875 meters.
 NOTE—42.8 to 52.6 meter band used for the development of apparatus for picture transmissions.
 66.25 to 70.1 meter band reserved for Mutual Telephone Company, Hawaii, for inter-island telephone service, 133 to 150 meter band now being used experimentally by this company for the same service.
 109 to 120 meter band used by voluntarily equipped tug boats and small pleasure craft.

Potato Peelings

By Gerald F. Dunn

“AW, BUT, ma, why can't I go to the radio school. It's two whole—”

“Yes, I know that it is two whole months before you have to go back to school, but you can't go and that's final, so don't ask me again, and don't try to coax your father to let you go. You are only thirteen years old, and the first thing we know you will be wanting to go away on a ship if you get a radio operator's license.”

“Aw heck,” said Bob O'Connor, only son of Weston's leading banker as he threw his cap on the floor of the sunporch, “I'm gonna beat it to New York and take a boat to China.”

“You'll do nothing of the kind, young man. You pick up your cap this minute and go out and play baseball with the rest of the boys.”

Mrs. O'Connor was mildly surprised at the rapidity with which her son complied with her instructions, for a moment later he picked up his cap and disappeared through the door, bound for his favorite “hang-out,” Joe's Radio Shop.

About three blocks from home, he was attracted by a raucous screeching, sounding suspiciously like the noise emitted by a badly controlled loud-speaker. He walked on for another half block, the noise of the loud-speaker, for so it was, steadily growing in volume, when to his surprise he discovered that Allen's Hardware Company had installed a new radio department, with two loud-speakers hanging in front of the store.

Joining the group of idlers listening to the horns, Bob gazed enthralled at what he had never before seen, but which was nevertheless his dream of the perfect radio set—a ten-tube combination tuned radio-frequency set, with changeover switches for a superheterodyne. And sitting beside it was the prettiest little ten-watt transmitting set that he had ever heard of or seen pictures of.

So intent upon his study of the two sets was Bob that he didn't notice the presence of “Bull” Dolt, best dressed habitue of Weston's underworld, until the latter, sensing the “psychological moment,” stepped up to his side.

“Pretty nice looking sets, eh kid?” was “Bull's” opening remark.

“You bet. I only wish that my pa would let me have them, especially that sending set,” replied Bob.

“Kinda like to ‘pound brass’ for a while, huh?”

“I'll say I would,” was the enthusiastic response.

“I'm a commercial ‘op.’ Just got on the beach and I brought back a good set with me. Want to take a look at it sometime?” Although “Bull” knew nothing about technical radio, he was quick to see the opportunity to put his plan to work.

“Let's go right now,” suggested Bob, eager to see a real operator at the key of a radio set.

“No sooner said than done,” said Bull as he led the way to his machine.

Already he could see prospects of a rosy future on Easy Street for himself.

During the next hour, Bob was so occupied by the exhibition of speedy driving put on for his benefit, that together with “Bull's” ramblings of India and the Orient, and the rushing countryside, the machine had travelled forty miles before “Bull” turned into a side road and brought up before a small, low ranch house, apparently deserted.

“Where's your antenna?” was Bob's immediate query.

“Oh, I use a Beveridge system.” “Bull” had seen the term in a radio magazine.

“Gee you must have some set. Let's go in and look at it so that I can watch you for a while before I have to go home.” Bob had never heard of the Beveridge system, but it sounded like the real stuff to him.

Driving the car into an outhouse, “Bull” drew out a ring of keys, and beckoning to the boy to follow, he went on to the door of the house and adjusted

(Continued on Page 54)



“Meanwhile Bob went on peeling potatoes, toying with the peels on the table.”

Hornless Types of Loud Speakers

An Analysis of Their Theory and an Account of Their Performance Possibilities

By Dr. John P. Minton

IN an article published in October RADIO I discussed the limitations of horn types of loud speakers from the viewpoint of perfect reproduction or performance. Such deficiencies in performance are present to more or less extent in all types of horn loud speakers and the determination of the superiority of one of these over the others of the same type resolves itself down to the simple determination of which one has these deficiencies to a less extent. It is not necessary to restate these limitations here as they may be reviewed by reference to my article; they may mean the ultimate exit of the horn speakers.

In the present article I wish to discuss the hornless types of loud speakers with a view to the ultimate performance possibilities of this device. I do not desire to discuss any one design, but to consider all the various designs as grouped under one type and contrast this with the horn type.

Our tests and observations have been made in various ways, such as described in my article in the September issue of this magazine. It is natural to depend upon ear tests inasmuch as the ear in the last analysis is the final judge and loud speaker reproduction must satisfy its judgment. Such tests nevertheless are unreliable to as much as 50% because ear judgment is a very poor measuring instrument. Furthermore, no records are available for future use in development work. Accordingly, we have made all the listening tests but have depended mainly upon our sound pressure measurements at various frequencies and these measurements are reliable and accurate to within 10%. They can be repeated at any time with this precision. Our results therefore represent facts which can hardly be denied to exist. The conclusions therefore since they are based upon precise acoustical measurements and at least upon an average judgment should perhaps be more reliable than the average ones ordinarily presented to the reader. Let us enter at once then upon the discussion of the subject matter.

What is a hornless loud speaker? A loud speaker unit is a vibrating body designed to respond to the radio signals. This response in the form of mechanical vibrations of certain parts of the unit, is feeble and the amount of air set into vibration by such a unit is so small that it can be heard with only considerable difficulty. We must find a way to permit the unit to set into vibration a large amount of air. If this is done other

than with a horn we have a hornless loud speaker. There is nothing new in this general principle—it is as old as musical instruments themselves. Vibrating strings correspond to the loud speaker unit. They of themselves would give out very little sound. When, however, we attach them to a sounding body, so to speak, they set a large surface or volume of air into vibrations and we have, therefore, sounds of greatly increased intensities, so much so that large audiences can now hear and the sounds are intense enough to travel relatively great distances. In one case we may have the piano sounding board and the music is that from a piano. In another case we have a violin body and the music is different, corresponding to a violin. In numerous other cases the shape or size, or both, of a body is altered and we have the various stringed instruments, each with their own characteristics.

Now a hornless loud speaker is exactly the same as these. We may use any one of them, the violin body, the piano sounding board, a plain piece of wood, etc., etc. Fifty years or so ago Professor Tyndall of England used various sizes and shapes of loud speakers to enable large audiences to hear music. His musical instrument was in the basement of a college laboratory and his unit was a rod resting on the sounding board of the instrument and extended to the third floor. The rod was set into vibration by the instrument and corresponds exactly to the vibration of the armature and rod in certain types of a hornless loud speaker. Just as we cannot hear with ease the sound produced by this rod because of its small surface so Tyndall could not hear the sound from his rod very well. Accordingly he attached various vibratable objects to the rod. Such objects as boxes, serving trays, felt hats, wooden boards, etc., were used and the sounds were sufficiently loud to enable all the members of his classes to hear. Thus, in a college laboratory of acoustics the first hornless loud speaker was devised and served its purpose nicely. Since then many changes have been wrought in the art.

In the horn type of speaker the diaphragm of the unit is too small to radiate much sound by itself. The purpose of the horn is to reduce the acoustic impedance between the loud speaker unit and the surrounding air to a point where sufficient sound radiation is obtained. The trouble however with a horn is that it does not radiate equally at all frequencies and it radi-

ates particularly well at its various resonant frequencies where the acoustic impedance becomes quite small. Both these properties represent both an advantage in one sense and a disadvantage in another.

When we eliminate the horn, we no longer get sufficient sound, except possibly at the resonant frequency of the diaphragms. Below this frequency the stiffness of the diaphragm prevents large vibrations of the small diaphragm and above this frequency the mass or weight of the diaphragm prevents them. Accordingly, hornless loud speakers must have a vibrating body whose vibratory characteristics are more suitable than those of a small iron diaphragm for sound radiation. To accomplish this, numerous ideas have been advanced and some of them have yielded fruitful results.

Amongst the many surfaces to suggest themselves, a large flat one is the most natural one to consider. The characteristics of such a surface depends upon the material of which it has been made, how it is supported at the edges, how large it is, how thick it is, how stiff it is, how heavy it is, etc., etc. Let us consider how such a surface functions in order to give off sound. To be specific let us suppose a balanced armature type of unit with a driving rod attached to the armature at one end and at the other to the center of the surface to vibrate the surface. As the radio signals cause the armature to vibrate, these motions are communicated by means of the driving rod to the center of the surface. Here begins the physical phenomenon which determines how much sound is going to be radiated or how loud the signals are going to be.

To cause any portion of the surface to vibrate, vibrational energy, in the form of flexural vibrations of the surface, must be transmitted to all portions of the surface. The "intake," we might say, for this flow of energy is where the rod is attached to the surface. The energy travels out radially from this one point and sets up flexural vibrations of the surface. These vibrations are perpendicular to the surface of the material, that is, transverse, and hence set the air into vibrations which correspond to the sensation of sound. The nature of these flexural vibrations have an important part to play in the production of sound and the properties or physical nature of the material actually used have the

(Continued on Page 62)

Vacuum Tube Resistors

Their Use and Advantages in Grid Leaks, Resistance-Coupled Amplifiers and Current-Limiting Devices

By G. F. Lampkin, 8CAU-8ALK

VACUUM tube detectors and amplifiers are known to every radio fan who has graduated from the crystal-set class. Vacuum tube oscillators have acquaintance with all those who are termed "hams." These three uses of the tubes are by far the most common, and, as such, are known both in theory and practical operation to the majority of experimenters. By the use of the same theory, practically all other uses of vacuum tubes may be understood. One of the several other functions of the tubes is as a resistor, and a bit of practical data on their use in this capacity will no doubt enable the user to proceed more intelligently.

At first sight a vacuum tube as a resistor appears to be an expensive proposition. However, new vacuum tubes can be bought for a dollar; which, though "bootleg," will function as well in the capacity of resistors, as the higher priced tubes, as their characteristics approach closely enough those of the latter tubes. But even this approximate equality in price between vacuum tube and other types of resistors would not justify the use of the former, unless there were advantages to be gained by its use.

It is as the grid leak in an oscillator that the vacuum-tube resistor has outstanding advantages. The function of the leak is to furnish a high resistance path by which a negative bias can be placed on the grid of the oscillator tube, which bias keeps the plate current to safe limits. The bias allows high plate voltages to be used, with corresponding high outputs of power, without melting the plate by the heavy current which would otherwise flow. So far, except perhaps in the matter of adjustability, the two classes of resistors are on a par. But most radio-frequency oscillators are used as transmitters, either telephone or telegraph. And the vacuum-tube grid leak can be used to control either the telephone or the telegraph transmitter, or to combine both types in one set. Methods of telegraph control, or keying, with vacuum-tube grid leaks, were published some time ago in QST. A circuit is shown in Fig. 1 which permits the oscillator to be used for either phone or telegraph transmission. For telegraphy, the microphone is left out; with the key up, the negative grid bias raises the plate, or oscillator-grid-leak resistance, to a value where oscillations stop. With the key down, the leak resistance has its nor-

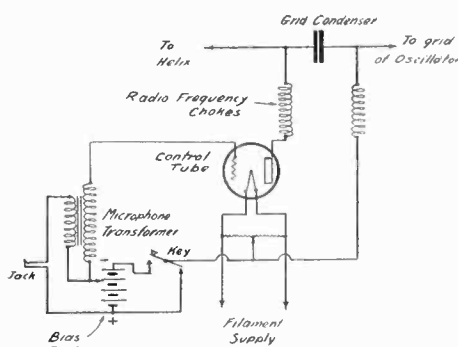

Fig. 1. Use of Vacuum Tube as Grid Leak.

mal value, and energy is radiated. In practice, the negative grid bias should be adjusted till the transmitter gives no appreciable radiation.

The arrangement permits high-powered sets to be keyed without breaking heavy currents—thus obviating any necessity for large keys or relays. It eliminates abnormal surges in the transmitter, which would cause key thumps to be radiated; and which would throw heavy strains, both mechanical and electrical, on the tubes, with consequent shortening of their lives. And finally, the arrangement provides a resistor which may be easily adjusted to give best operating conditions in the oscillator.

In view of recent articles in RADIO, describing the use of vacuum-tube grid leaks in grid modulation systems, data on their resistances is specially pertinent. The articles enumerated the advantages of low cost, simplicity, and effectiveness, for the grid modulation system. These qualities, then, are had in the grid-modulation circuit of Fig. 1. To modulate the set, the microphone is plugged in the open-circuit jack, and the key closed. With the key down, the transmitter radiates normally. When sound is impressed on the microphone, the resulting voltage fluctuations in the secondary of the microphone transformer cause corresponding changes in the plate or grid-leak, resistance; and finally, the change is manifested in the output power. The magnitude of these changes, and the necessary values of bias voltage, filament voltage, etc., can be determined from data given in the curves.

The receiving-set experimenter has a use for vacuum-tube resistors in resistance-coupled amplifiers, for either radio or audio frequencies. Although the advantages are not so pronounced as in the case of grid-leak resistors, still, an important one is had in the matter of ad-

justability. By varying the filament voltage, or applying a few volts negative bias on the grid of the coupling resistance it may be varied within wide limits. It should be possible to heat the filament of the resistor with alternating current, with no resulting hum in the output. It has been determined that the hum usually heard in attempts of this kind is due to some a. c. voltage on the tube grid; and not to any thermal, i. e., heating and cooling of the filament, effects, nor to magnetic effects of the alternating filament current on the electron stream. So if the grid of the resistor tube is left free, or connected so that no 60 cycle voltage is impressed on it, no hum will result. The inherent advantage of resistance-coupled amplifiers is freedom from distortion; the inherent disadvantage is low over-all amplification and waste of *B* battery. The greater the coupling resistance, the greater is the amplification obtained, but the *B* battery waste is also greater. So here is a hint to experimenters—build a resistance coupled amplifier and *B* battery eliminator to work together; then high amplification, undistorted, can be had without high cost for plate energy.

The above are the principal uses for vacuum tube resistors. They may of course be put to other uses, where a variable resistance of comparatively low current capacity is needed; or they may be used as current limiting devices, due to their inherent saturation effects.

The tubes which were measured for resistance data were a UV-201A and a UV-202. The first is suitable for 5 and 50-watt-oscillator grid leaks, and for receiving-set resistors. The UV-202 is suitable for the grid leak on higher powered oscillators, or where a comparatively heavy current is to be carried. These two tubes were selected as representative, and easily obtainable. To remove any doubt of the ability of the 201A thoriated filament to sustain a large current drain, it was run continuously for 62 hours, with constant filament and anode voltage. And during that time, the 35 milli-ampere anode current being drawn remained absolutely constant. Even if the emission of a 201A should fall, burning the filament for a short time with no applied plate voltage would restore it. It is possible to kill the emission of a UV-201A at 5 volts filament, and then run the filament voltage up until the tungsten core becomes hot enough to emit electrons. One previ-

ously dead tube emitted 150 mils at a filament voltage of 10—but the emission was extremely erratic, due to the thorium still inside the filament. Therefore no measurements were taken on the 201A under these conditions.

A resistor was placed across the tube filament supply, and center tapped for the filament returns; for a current of .35 mils flowing down one side of a 201A filament makes an appreciable difference in its temperature, easily visible. The anode consists of the grid and plate of the tube connected together as the positive terminal.

The curve of saturation current vs. filament voltage, Fig. 2, shows the maxi-

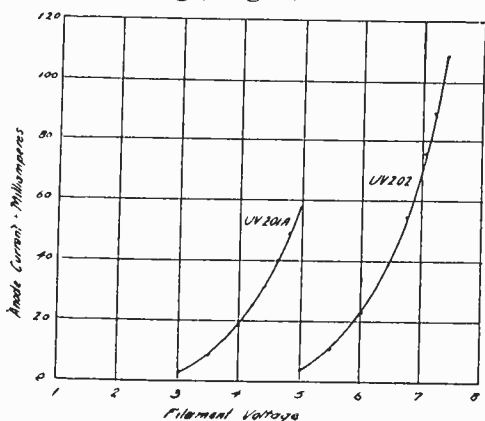

Fig. 2. Saturation Current Curves.

mum current which the tube will pass at any given filament voltage. A five-watt oscillator tube should have a grid current of approximately 3 to 4 milamperes, a fifty-watt tube 15 to 18 mils, and a 250-watt tube 40 to 50 mils. Each tube in a parallel combination passes the same current, so the total grid current will be as many times that of a single tube as there are oscillator tubes in parallel. Knowing the total grid current, it can be determined from the saturation curves which resistor tube is necessary for a grid leak. For reasonable life the 201A should not be run above 45 mils anode current. If the tube leak is to be used in a modulation system some leeway must be allowed; and the tube should be capable of passing more than the normal oscillator grid current—say, twice as much.

If the vacuum-tube grid leak is to be used in a telegraph transmitter only, the most satisfactory way of varying the re-

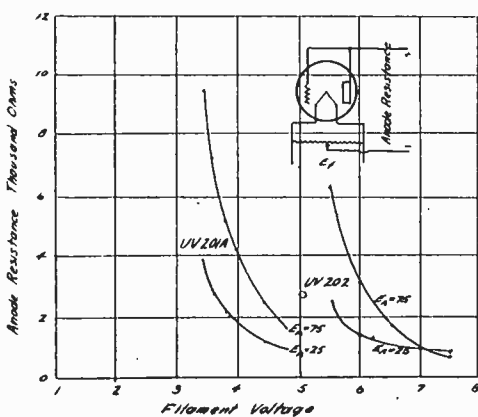

Fig. 3. Curve of Anode Resistance Variation With Filament Voltage.

sistance is to change the filament voltage of the leak, so that the resistance will vary with filament voltage as in Fig. 3. The two curves at an anode voltage of 25 are below filament saturation. The last point on the UV-202 curve for 75 volts anode is below saturation. All other points for 75 volts, both 201A and 202, are with the filament saturated. That is, all the electrons emitted by the filament are drawn to the anode, and no matter how much higher the anode voltage be raised, no more current will flow. As the resistance is figured as E/I , and I remains the same, the resistance will rise proportionally with the applied anode voltage. This is desirable for a telegraph transmitter. If the filament of the grid leak is turned down, only the saturation current can pass. Any more electrons attracted will pile up on the oscillator grid, making it more negative, and lowering the amplitude of the oscillations. This decreases the electrons passing to the grid—so that a final balance is struck. The net effect is to raise the grid-leak resistance, even though it is done with the aid of saturation.

The tube used for a grid leak in a modulation system must not be saturated. If it were, fluctuations in its grid bias could produce no change in its plate resistance, and consequently no modulation. The statement that the saturation current on the tube leak should be twice the normal oscillator grid current is not empirical; it is only a safe guess. The actual leeway required can only be found by experiment—cutting down the filament voltage until the quality of modulation drops. To get the desired normal grid-leak resistance, the filament of the leak should be adjusted, with the aid of the saturation curves, to give the necessary leeway in saturation current, and then a grid bias applied to bring the resistance to the correct value.

The bias necessary can be determined

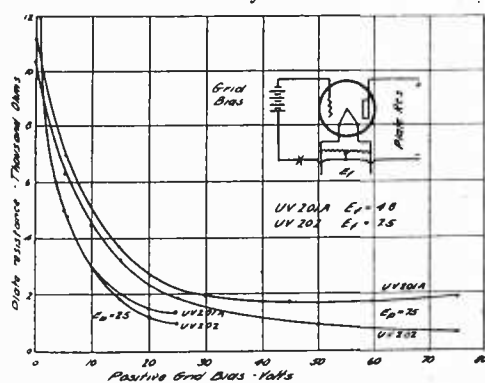

Fig. 4. Effect of Plate Resistance

from the curves of Fig. 4. These curves show that, if possible, the bias should be kept near zero. Then small variations in grid bias, from the secondary of the microphone transformer, will produce tremendous changes in grid leak resistance; as shown by the steepness of the curves at this point. This is a fortunate fact, and undoubtedly accounts for much

of the effectiveness of the grid modulation system. It is better not to have a high resistance in parallel with the vacuum-tube leak, for with a resistance in that position, it is impossible to obtain the full effect of the tube resistance change; and the lower the shunt resistance, the greater the deadening effect. It is much better, if necessary to get away from saturation effects, to use a larger tube for the leak.

Another method of varying the tube resistance is to connect the grid to the plate of the tube through a resistance, and to change the value of this resistance. With zero resistance in series, the grid would be positively biased to the same value as the plate voltage. The insertion of the grid-series-resistance lessens this positive grid bias by the value of the voltage drop across the resistance, caused by the passage of the grid current. Lessening the positive grid bias increases the tube resistance, as shown by the curves of Fig. 4.

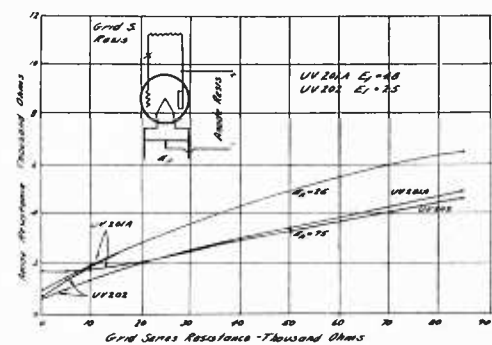

Fig. 5. Effect of Varying Anode Resistance With Grid Series Resistance.

Fig. 5 shows the relation between values of grid-series-resistance and of anode resistance. The upward bend of the UV-201A curve, at 75 volts anode, is again caused by saturation. The circuits of either Figs. 4 or 5 may be used for modulation, if the secondary of the microphone transformer is inserted at X. The filament side of the tube leak must connect to the oscillator grid and both leads to the oscillator must contain radio-frequency chokes. The grid-series resistance does not require a current-carrying capacity of more than 4 or 5 mils; and in some cases it may be more convenient to use than a grid bias battery. Experiments only can tell if there is any difference in the modulating qualities of the two connections. Doubtless there is none.

Grid leak resistance variation affects the power output of an oscillator and it should be borne in mind that for undistorted modulation the output power of the oscillator should change proportionally with the sound impressed on the microphone. With most microphones and microphone transformers this requirement may be changed to proportionality between output power and grid voltage fluctuation on the vacuum-tube grid leak; for the distortion in the

(Continued on Page 68)

Modernizing An Old Receiver

Simple and Practical Directions for Making Single Circuit Tuner
More Selective and Non-Radiating

By D. B. McGowan

PROBABLY there are still in this world a FEW persons who bought in good faith one of the much cussed, discussed, and condemned radio receivers known as the Westinghouse "RC and RA" so-called tuners. It is now too late to re-open the discussion of the merits or demerits of the tuner, but despite the very obvious lack of selectivity of this set, there is really little against it, from the user's point of view, except its propensity to radiate, and "bloop" with the carrier waves of various stations.

As there were many thousands of these sets sold to the public, many of which still must be in service, the following description of how the equipment was redesigned and modernized should be of interest, especially to those who live in the more crowded sections, where there are many more radiocast stations going at the same time, all of which interfere to some extent with each other on these receivers. The need for disturbing the original set as little as possible was kept in mind, when re-designing, and it is believed that the success attained well warrants the changes.

The Westinghouse R. C. set is a direct coupled affair, commonly called a "single circuit" receiver. Therefore, the simplest re-arrangement to obtain selectivity is to make it into a conventional tuned coupled circuit set. By doing this, we at once get away from two of the most undesirable features of the set; first its broad tuning qualities, and second, the radiating effect, which takes place when the tube is oscillating. No claim is made that the changes will entirely remove all these troubles, but the changes so improve reception that there is no comparison with the original operating condition.

Besides this, the detector and amplifier panel is rather out of date. The circuits were designed to accommodate the soft or gaseous detector tube, and the one ampere filament amplifier tubes, types C-300 (UV-200) and UV-201 (C-301), respectively. The system of coupling between tubes, in the original layout is not the most ideal in view of modern practice, as iron core transformers of quite doubtful frequency characteristics were used so that this unit was re-designed to give very much better results as far as tone quality is concerned, than the original.

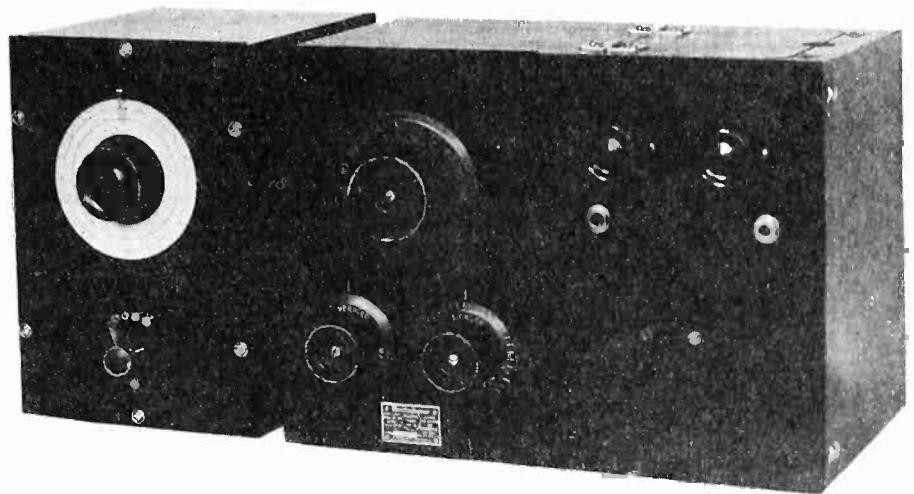

Fig. 1. Front View of Rebuilt R. C. Receiver.

The accompanying pictures show the entire equipment, as it was rebuilt. Referring to Fig. 1, the front view, at the left is the antenna tuning unit, which permits any desired degree of loose coupling; in the center, the usual "tuner" unit, which is not disturbed, except as to certain of the interior connections, and on the right the amplifier panel, with the necessary controls. The tuner and detector-amplifier unit are mounted on uniform panels, an entirely new panel being substituted for the detector and tube control unit instead of trying to use the old one which was discarded. Two rheostats are provided on the detector-amplifier panel, to permit filament adjustments, one rheostat controlling the detector tube alone, and the other the two amplifier tubes. Only two jacks are provided as it has been found that there is usually no need of a jack in the detector circuit, owing to the low power output from the detector tube.

The rear view of the set is shown in Fig. 2. To the right is the antenna tuning unit, the antenna loading coil and taps at the bottom, and the variable air condenser partly visible at the right of the bakelite tube. To the left is the "tuner" unit and next the new detector and amplifier apparatus.

In order to obtain better tone quality the impedance coupled type of amplifier was selected as being the most suitable, and was made with high resistance grid leaks for coupling units and choke coils for the plate circuits. The latter may either be a set of Thordarson Autoformers or the primaries of the ordinary bell-ringing transformers.

The antenna tuning unit was made by mounting a Remler condenser on the panel, in the usual manner at such a height that the dial matched up with the height of the tuning dial on the original, as can be seen in Fig. 1. The antenna loading coil was then mounted on the

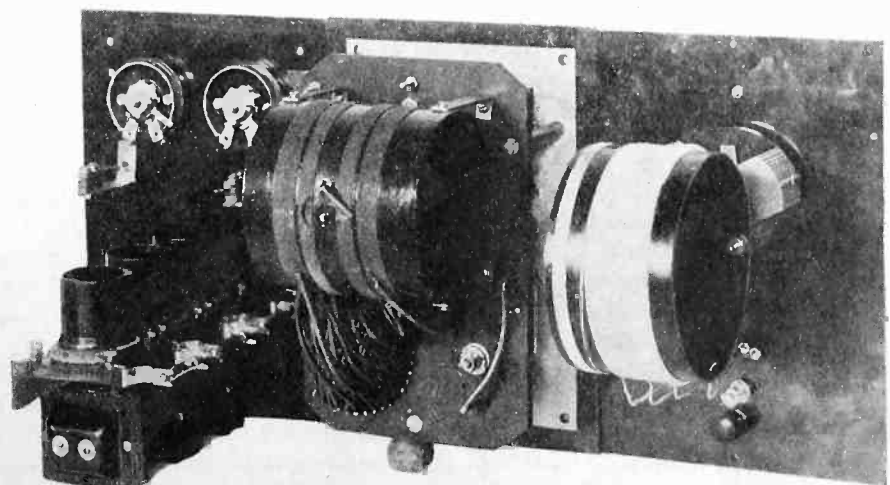

Fig. 2. Back View, Showing Antenna Tuner Panel.

back of the condenser, the two terminal screws of the condenser acting both as terminals, and supporting screws for the inductance. The latter is made up of 80 turns of No. 24 d. c. c. copper wire, divided into four sections as follows: 1st tap 8 turns, 2nd tap, 16 turns, 3rd tap, 36 turns, and the last tap including the entire winding. The first tap was wound in a single layer, and the other winding is a "double banked" affair. This was done to conserve space, and to increase the inductance of the coil. Actually this coil is larger than need be for the average set, and a single layer coil, wound on the same size tube containing about 2½ in. of single layer winding will probably be sufficient. In the set pictured, the coil will cover the entire broadcast band, from the very lowest, to the highest, with almost any sort of an antenna under 150 feet in length.

The three tubes are mounted in a three-gang socket of Frost make, which is arranged with rubber shock absorbers under each socket. This particular socket is also well adapted for mounting on the panel, end-wise, and on one side the three grid-leak resistances are mounted, end to end. Under the sockets the plate choke coils can be seen, and they are also screwed to the bakelite socket support. Three 1.0 mfd. condensers are mounted on the far side of the socket supports. These do not show in the picture, but are at the extreme left behind the sockets. Thus the whole amplifier unit, with the exception of the rheo-

formers, or choke coils of similar type would serve as well, but care should be taken to see that they can be mounted under the socket support, if the same scheme of mounting is to be used.

An antenna binding post is provided inside of the primary, or tuning unit inductance coil. This is one terminal of the condenser, and is invisible in the picture. The ground connection is made to the switch, and a binding post is fastened to the panel, projecting inwards, visible just under the switch, on the right in Fig. 2.

The antenna tuning unit is mounted in a separate box, which is not connected electrically in any way with the closed circuit, which comprises the original tuning elements. There being no shielding on either the antenna tuner box, or on the closed circuit unit, it was found that very satisfactory coupling could be obtained by mounting the antenna coil at the same height as the secondary, in the original tuner. Variation in coupling, and the resultant reduction in interference can be accomplished by simply moving the antenna tuner unit away from the secondary tuner, until the desired looseness of coupling is obtained. This usually will not be very critical, and need not be changed a great deal after it has been once set. Even with the two units set end to end, as shown in Fig. 1, the coupling between the two circuits is quite loose, and good selectivity is obtained. The actual position must be determined by experiment, in each case.

modern radio frequency and super-heterodyne receivers, it will surprise the user how the rebuilt set of this type will be improved. It will eliminate entirely the "haze" of other stations, which is so often found when using the original circuit, and thus reduce interference. The actual selectivity possible with this set depends on several variable factors, among them being the antenna used, and the proximity to powerful radiocasting stations and the skill of the operator. As this set is now inductively coupled, it is possible to use a "trap" to eliminate interference in the antenna circuit with much greater satisfaction than was the case with the old circuit. The radiation, or "blooming" caused by the oscillation of the detector tube is reduced and should not bother nearby listeners, an important factor.

Comfortable volume from the average loud-speaker will result on most stations with 90 volts plate potential, and 4.5 volts grid bias, as shown in Fig. 3. If more power is desired, such as to operate a large cone loudspeaker, a third stage of amplification may be added, using one of the newly developed power amplifier tubes, such as the UX-CX-112, with 160 volts plate potential and 10 volts C battery.

ESPERANTO NOTES

The postal administration of the Soviet Government has issued a seven kopek stamp bearing a portrait of Popov, famous electrical engineer, with a background of the antenna of the Moscow station. The stamp has "Inventisto de Radio Popov" in Esperanto over the portrait which is the first time that this international language has so appeared, or that radio has had such an acknowledgment. It is also the intention of the administration to issue postals with the words "Postal Cards" in Russian, French and Esperanto.

Radio-Geneve is now operating on 1100 meters at 1½ k. w. The programs are radiocast in French and Esperanto and a course in the latter language is given every Tuesday. The majority of the stock in the new enterprise is owned by Esperantists throughout the world whose active head is Dr. Edmond Privat, president of the Universal Esperanto Association, with headquarters at Geneva. The station is subsidized by the Swiss Government allowing 6% to the stockholders.

The international conference of member states of the Universal Postal Union, sitting in Paris, has officially recognized Esperanto as a "clear" language in accordance with the recommendation of the fifth Plenary Session of the League of Nations. This action is official recognition of Esperanto as an international auxiliary language.

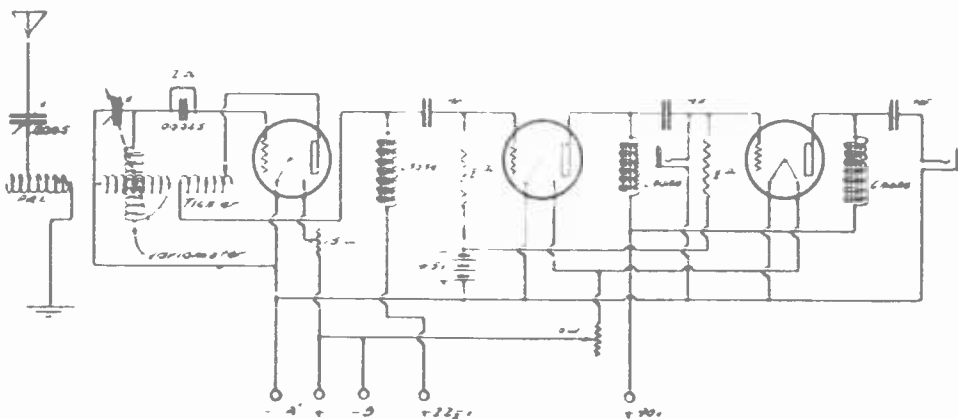

Fig. 3. Schematic Wiring Diagram.

stats and jacks, which are on the panel, is attached to the Frost three-gang socket mounting which greatly facilitates the wiring and assembling of the set.

The plates of the vacuum tubes are fed through the choke coils, which, owing to their high inductance prevent the voice frequency currents from short-circuiting through the B battery. The ones used were "bell ringing" transformers, of the 10 watt variety, which serve their purpose very well. As space was limited, the secondary, or low tension binding posts were cut off flush with the case, and left open circuited, the high (primary) winding marked "line" running to the proper terminals for the plate supply. Other trans-

Fig. 3 shows the circuit diagram, which does not differ from tuned coupled circuit regenerative sets of the usual type. The interior wiring of the original tuner is not altered in any way, except to remove the long terminal screws, which projected through the back of the original case. These were unscrewed, and leads taken from the various apparatus and terminals. The battery terminal block, which accommodates the A and B batteries are not shown in Fig. 2, but are mounted on the panel, to the right of the tube socket gang. The antenna and ground connections, as provided on the original tuner are, of course, short-circuited, to complete the circuit.

While not the equal of some of the

Proper Reflex Circuit Assembly

Practical Suggestions for the Construction of a Three-Tube Inverse Reflex Receiver

By L. W. Hatry

THE reflex set is the great experimental "piece de resistance." But for the home set builder it has proved to be of the same gentle genius as the bucking broncho to the tender-foot—a horse not to be successfully ridden. Many experienced tinkers have given up the reflex set, some because they can't get distance, and others because it will not perform without distortion. Another group assert it is "de bunk" to expect a tube to perform more than one job well. But unanimously they regret that they think any of these things since it does save tubes—then they build another reflex.

The writer asserts, without fear of vigorous contradiction, that a single reflexed tube suffers from practically none of these condemnations. Even in a set employing more than one stage of radio-frequency amplification, a single reflexed tube generally has proved satisfactory. The one-tube reflex may safely then be said to be a practicality. Setting aside commercial productions or similar sets made effective after long and arduous experimentation, the multi-tube reflex has not proven an entirely satisfactory practical thing.

Before we can go further, an understanding of the relation between sets employing reflexed circuits and sets with unreflexed circuits is necessary. We cannot compare the reflex, tube for tube, with an unreflexed set—although some reflexes would need a handicapped standard even on that basis. The reflex is supposed to make one tube perform as two.

The comparison should be between a two-tube reflex, with one tube as a detector, and a three-tube set consisting of r. f. amplifier, detector and one stage of audio frequency amplification. In both cases electrical conditions should be similar; the detector regenerative or not, the r. f. amplifier tuned or not. With similar external conditions the two sets will be found to perform nearly the same, with the greater volume in the unreflexed set. This last is generally ascribed to the fact that a tube should not be expected to do two things as well as it could do one. This explanation, barring overload, is a doubtful one.

In general, the home-made reflex set is not built according to the best and probably most useful radio-electrical practice. Some things are neglected that are worthy of better treatment. The essential purpose of this article is

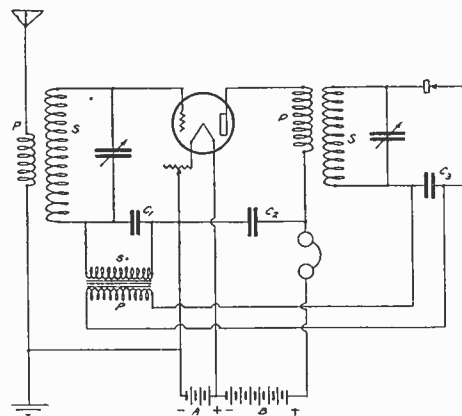

Fig. 1A. Circuit Diagram for One-Tube Reflex with Crystal Detector.

to suggest component arrangements and circuit constants and additions that have a sound radio-electric basis.

One oversight in most of the reflex diagrams is failure to see that all currents stick to their proper circuits,—so that the r. f. energy does not stay in bounds, causing loss of amplification through the adoption of mal-practices necessary to avoid howls and squeals.

Fig. 1A shows a one-tube reflex circuit with crystal detector and tuned r. f.

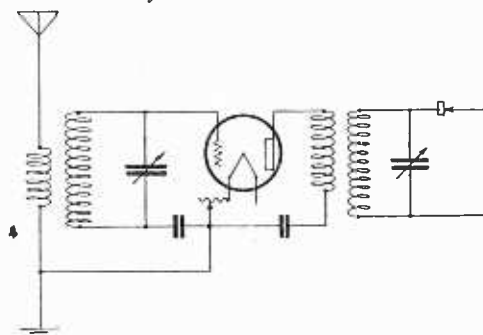

Fig. 1B. R. F. Portion of Fig. 1A.

transformer; B and C respectively illustrate the r. f. and the a. f. circuits, the heavy wiring of C showing where the r. f. should be absent.

This isolation is generally accomplished by shunting with condensers so

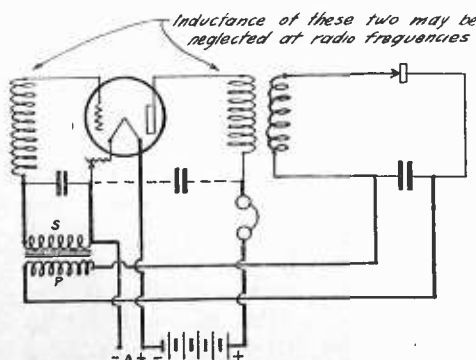

Fig. 1C. A. F. Portion of Fig. 1A.

as to provide a low resistance path for the r. f. energy, as is done by C_1 , C_2 and C_3 of Fig. 1A. But the distributed capacity of the windings in the a. f. transformers may also provide such a low resistance path. To use larger condensers in an effort to avoid this, reduces the amplification and causes distortion. So we insert a radio frequency choke coil as shown in Fig. 2.

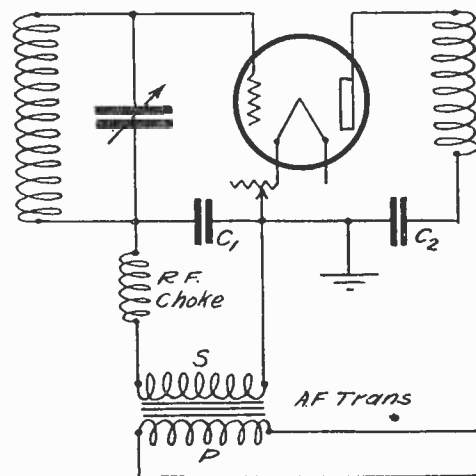

Fig. 2. Placement of R. F. Choke Coil.

The reactance of this choke coil should be sufficient to force the r. f. through the shunt condenser path. It can consist of 500 turns of No. 30 to 40 d. s. c. wire wound on a small paraffined wooden spool. Haphazard winding will reduce the distributed capacity and a small size will reduce its electromagnetic field. Its inductance should be about 15 millihenries. The filament battery should be grounded.

In using by-pass condensers to isolate the radio frequency portion of the circuit, remember that if the frequency is doubled the reactance, or effective resistance of the condenser, is halved. Likewise if the capacity of a condenser is doubled at a given frequency the reactance is halved. The relative reactance of different condensers is shown in the following table:

Capacity in mfd.	Reactance in ohms	
	at 500 k. c. (600 meters)	1500 k. c. (200 meters)
.001	650	210
.002	325	115
.003	210	70
.006	105	35

The condenser's reactance in ohms should be lower than that of the circuit it by-passes. Thus the by-pass condenser for the low resistance circuit of the battery leads should be about 0.5 mfd. But by no means allow this large capacity to

(Continued on Page 80)

The Lowly Low-Loss

A Nonsensical Satire on Current Radio Treatises

By Jack Bront

THE matter of losses strikes genuine terror to the heart of the radio technician, but it is the daintiest morsel masticated by the "expert." So under the stress of public sentiment the lion and tagger hunt in the Bay district was foregone, and the entire resources of the Hoboken laboratory were devoted to the study of lo-loss. Paradoxically enough, losses are to be shunned like the plague, rather than searched out in their respective kennels. Gains should appear the main objective in the radio fields;—gains in stations heard, gains in miles per microfarad, and gains in the versatility of those blue-black whoppers reciting the absolutely deafening crash of Habana on the single C-199 (with base, filament and grid removed).

If all the expert treatises on lo-losses were placed end to end, they would extend entirely around the bankroll of the Standard Oil Company. If all the whoppers told about lo-loss were recorded on phonograph records, they would entertain the populace of Mexico for 987 years, without a break in the charming sequence. Taking it on the other hand (the low loss), if all the lung power expended were converted to kinetic electric energy, the result would supply all the submarine cables of Switzerland with 3 volts at 37 amperes for 9 centuries, inclusive of the higher rates necessary for the transmission of the Scandinavian tongue below tidewater level.

Primarily, the attack on low losses has never been in the vulnerable sector. We readily admit the expression: "Losses creep in." From this we infer that they are low and cunning, and should be dealt with obviously with corresponding guile and discretion. One method is to absorb sufficient courage from the hair raising treatise of some "expert," and then get down in the labyrinth of the receiver and throw them out bodily, —if not from necessity, then for the moral effect.

View the despicable character of the hi-loss socket! The experts in some number agree on the vital fact that within the crafty innards of the innocent appearing socket lie all the treacherous and vicious attributes of the female she-wolf. Professor de Matsonia sponsors the invariable use of the lo-loss socket, he maintaining that if this were done, the building inspectors in any great city would O. K. no architect's plans unless the building were to be erected on armor plate and builded of fabricated steel. One must be open minded.—At this

juncture, the laboratory assistant accuses the writer of being so open minded as to perceive no issue therefrom. Nevertheless, I have rushed a job to the printers, entailing 987 requests for introduction to these gents that have measured them resistance of those socket.

Parallel with the esteemed professor's theory, the humble writer has led the waiting world down through the labyrinths of research, and has discovered that when green raspberries are brought within a few millimeters of a radio current carrier, no loss is apparent,—yet if the entirety of a ripe watermelon is placed in juxtaposition to the average radio receiver, in use,—the loss will be 100% (of the watermelon). I can concede nothing whatever as to any discrepancy between the value of my discovery, and that of the esteemed professor's.

Doctor Gazook points out in "Sulphuric Acid as a Beverage" that a litre of "sulphuric acid poured over the average superheterodyne will stop all losses at once. What signals do come through will be so clear that it may be found that the signals have cleared out altogether." It is apparently a matter of technical knowledge.

Losses in signal strength due to static have been investigated by Professor Enchilada of the Tia Juana conservatory of cayenne, and he states: "Remarkable freedom from static losses in reception were discovered when the antenna was taken down and sealed in a tank of iron with brass handles. The importance of the brass handles is vital. Much depends upon the handles being of pure brass with a high polish."

Commenting on the above theory, Doctor Kalveslivver deplores the fact that signals were also eliminated as "no signals were heard after listening for seventeen days." In a spirited rejoinder, Professor Enchilada retorted that the critic should be informed: "that my research work is confined solely to the matter of static elimination. What in the name of the knock-kneed prophet has the signal to do with it? Static elimination has been the objective, and now is the accomplishment." There you have it. Well founded is the assumption that men of science are violable to petty squabbling over matters of such negligible moment as signals.

Doctor Fleischalter states that "in our experience on the Hippo River in 1924, we coiled down the antenna in a barrel of horseradish. The signals were remarkably strong, and there was en-

tire freedom from strays." Raymond Gaspipe, who translated the works of the Doctor, states in notes that the "strays" referred to are not relative to static, but are indicative of a jocular band of laughing hyenas who had been wont to stray into the doctor's camp and listen to the jokes of 1856 being rehearsed over the air by ambitious, if not suspicious, announcers in the U. S. A. Another squabble of noted scientists of this water. We presume the hyenas laughed boisterously in their overcoat sleeves at the hoary cracks of the radio and of the doctor's party, reserving some jocularly for the petty irritabilities of such capable minds.

The "Journal of Narrowcasting" deplores the laxity in loss elimination in the average receiver. "Losses must be eradicated at all costs. The wearing of felt boots while tuning is indicative of fervent purpose in this direction. It is little realized that the wearing of gumboots causes tremendous dielectric losses." (Note: The constant of gumboots is 2, except for one legged listeners, where it is 1. Hip boots—higher.)

"Faulty resonance," says Hendrick Vermicelli-Salami, "is liable to produce losses in the rheostat;" while Dextrous Tooner points out that "standing waves on linear conductors should be balanced, or there will be a fall to zero,—subsequently the wave sequence is ge-broken, and the plate atoms are hardened." (Note: The greatest precaution should be taken to avoid the hardening of the plate atoms. Every two weeks a test should be made. With mortar and pestle, a few should be tested, and those which have hardened should be thrown out.)

David Seltzerwasser indicates the skin effect as the seat of the most prodigious losses. He maintains that "a judicious distribution of snow shoes in the vicinity of the receiver will entice the currents to seek other paths in the stratas of the conductor than that of the immediate surface on the outer side. "He later recommended the use of oil on the bus wires to provide for the "smooth operation of the device and eliminate the friction of the dragging maximums."

Fredkjxz Mzskz, the Czecho Slovak correspondent of the Daily Mail, announces his discovery of a low loss rheostat. His device indicates the practicability of this invention. (This paper is carefully filed and all who may care to peruse it may do so. It has been

(Continued on Page 70)

Speech Modulation Methods

How Radio Telephony is Accomplished With Various Types of Continuous Wave Tube Transmitters

By Jennings B. Dow, Lieut. U. S. N.

SPEECH modulation of the output of a vacuum tube generator is usually accomplished by one of three general methods. The simplest is by variable absorption of the radio frequency output of the circuit. This may be done by inserting a speech-operated microphone in the ground lead of a continuous wave generator or by shunting the generator tube, or parts of the output circuit with another tube whose grid voltage is varied at speech frequencies by the use of a microphone and speech transformer. This method is seldom used in practice, largely because the generating device is required to produce much more radio power than that utilized by the actual antenna or other radiating device.

A second method of modulation is by varying the operating grid voltage of a generating tube at speech frequencies. In such apparatus the secondary of a speech transformer is inserted in the grid lead, this secondary being shunted with a radio condenser so that the operation of the generator circuit will not be influenced by the high reactance of the transformer windings. A microphone and battery in the primary of the transformer cause variations in the average grid voltage taken over successive radio cycles, and therefore change the operation of the radio generator. This method of modulation is not extensively used, chiefly because the radio frequency output of a generator circuit is usually not readily altered by varying the operating grid voltage. The grid voltage operating point is important in determining efficiency but not the output current, provided the conditions are such that good articulation results. By reducing the operating grid voltage on a generating tube sufficiently, usually a point is reached at which the oscillation suddenly breaks and the radio output current immediately drops to zero. Grid modulation which thus cuts off the antenna current suddenly and completely results in very poor articulation. While with careful adjustments the breaking of the oscillation may be sufficiently gradual to permit good speech, this method is not considered to be one in which the modulation process is inherently reliable in telephone sets. Fig. 1 illustrates a refinement of this method, wherein a second tube is used to vary the generator grid operating voltage. When this method is employed, the second tube should have a power rating equal to at least ten per cent of that of the generator tube.

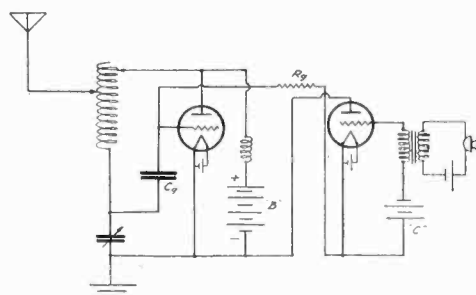

Fig. 1. Modified Grid Modulation Circuit.

A third method of modulation is by varying the input plate power of a generating circuit; that is, the average plate voltage and plate current of the generating tube or tubes of a radio circuit are caused to vary at the lower or modulating frequencies. This method is employed in practically all present commercial and military types of electron-tube radio telephone sets. It possesses the advantage over the first method that practically all the radio power output may be used in transmission of signals. On account of the nearly linear relations between cause and effect with this method, it is inherently superior to both the other methods as to articulation. In the transmission of speech signals the plate power of the generating tube is altered by the use of a power tube, which from its functioning is termed a modulator tube. It is the operation of this tube which is the center of discussion at this point. In connection with the discussion, however, are developed other topics, some of which are of interest in connection with any method of modulation.

A radio telephone set using plate modulation is a more or less complicated network in which three classes of currents co-exist—radio frequency, audio frequency, and direct. In Fig. 2 is shown schematically a typical radio telephone

transmitter set, analyzed for purposes of discussion into four distinct units. At the extreme right is the radiator unit, which joins up the transmitter with the distant receiving station. The signal which is conveyed depends upon the nature of the wave form of current in this radiator unit, and is independent of the process by which that current is produced. The useful currents in this circuit are of radio frequency. The modulating mechanism may cause slight audio currents to flow in the radiator unit, but these produce practically no effect except at near-by stations. In the figure shown, such audio currents result from the audio current flowing in the lead to the tube *O*, which is inductively coupled to the antenna or radiator circuit. During speech the radio frequency current is of variable amplitude and is known as modulated radio frequency. For this purpose of explaining the general operation of the transmitter it is unnecessary to analyze completely the wave form of the current.

To the left of the radiator unit is the radio generator unit. This contains electron tubes which, from the functions performed by them, are known as oscillator tubes, and also contains the other electrical equipment essential to the production of radio frequency power from whatever power is supplied at the input *b+* and *b-* terminals of this unit.

An essential part of any generating unit in radio telephony is a device such that the radio frequency voltage across the input terminals is small compared with other voltages of lower orders of frequency. In the present case this device is a condenser *C₁*, the reactance of

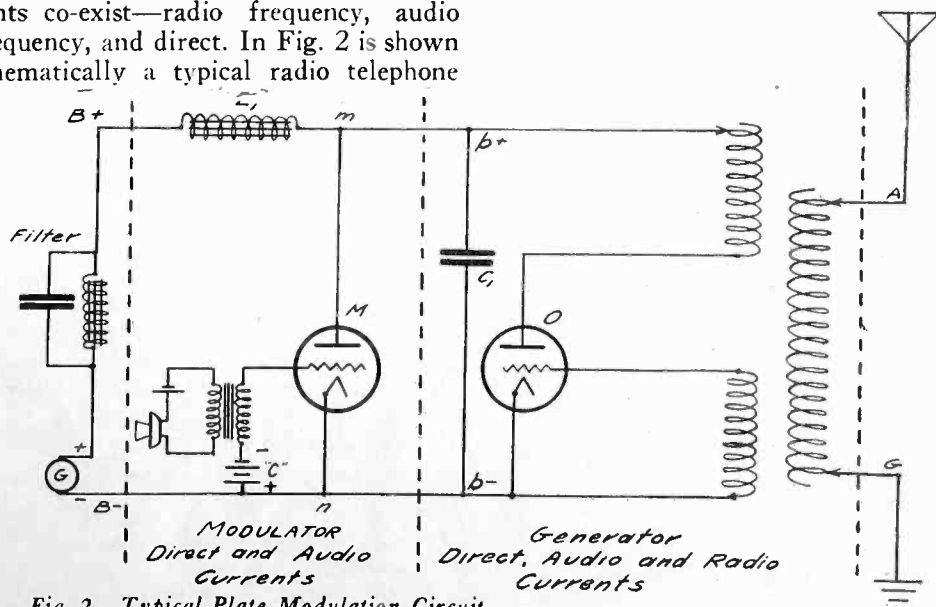

Fig. 2. Typical Plate Modulation Circuit.

which for radio frequencies is low compared with the ratio of average plate voltage of the oscillator tubes to the average plate current. In any continuous wave transmitter a device of this nature is required in case the radio impedance of the system supplying the plate power is so high that otherwise considerable radio voltage variations would occur across the input terminals, limiting the useful power output. In the present case the condenser C_1 may be thought of as an electrical check valve which prevents radio frequency power working back into the part of the network to the left, but which does not interfere with the lower frequency power entering the generating system.

The particular type of generating circuit shown in Fig. 2 is the Meissner circuit which is classified electrically as one with plate and grid both inductively coupled to the radio frequency circuit. In place of such a circuit any other type might be used. In the generator unit, all three types of electrical currents exist. The power entering the unit during operation is direct power and audio power. The output through the antenna and ground terminals, A and G , is modulated radio frequency. While a tube in continuous wave telegraphy may be thought of as a converter of power from direct to radio frequency, in a radio telephone set the generator tube converts power from direct and audio to modulated radio frequency.

To the left of the generator unit is the modulator unit, the function of which is to supply audio and direct power to the generator unit, the audio power being controlled by the operator speaking into the microphone. In the case shown, an electron tube is shunted across the input terminals of the generator unit, the two in parallel being supplied with direct power from a direct-current generator through the iron cored choke coil L_1 . The tube in this case is a speech-controlled resistance in which the instantaneous resistance, or ratio of plate voltage to plate current, is determined largely by the instantaneous grid voltage.

On account of the functions it performs it is known as a modulator tube. Mechanically it is usually the same as the oscillator tube. When tubes are paralleled, approximately as many modulator tubes are used as oscillator tubes. The modulator tube is a converter of power from direct to audio frequency and the audio current and voltage output of the modulator tube is a more or less faithful reproduction of the audio voltage impressed upon the grid of the modulator tube by the use of a microphone and transformer.

The modulator tube therefore functions as an aperiodic power amplifier. The power which is manifested by the heating effect upon the resistance, during speech, is entirely audio power, converted from

direct power from source E through the agency of the modulator unit. Tubes for modulating are usually designed to operate with a negative average voltage on the grid, which in the case shown is obtained by the use of a battery in the grid lead. The choke coil L_1 of the modulator circuit partially performs the same function for the modulator unit as does the condenser C_1 for the generator unit.

It prevents audio currents produced by the unit from working back through the input terminal $B+$ and $B-$, and in this, it is aided by the condenser C_1 . It performs, however, another important function.

If a fixed impedance and a variable impedance be connected in parallel and placed across a direct power source of zero internal impedance, then variations of one impedance will not disturb the current to the other unless the two in parallel are supplied with power through a common line impedance. The oscillator unit may be thought of as the fixed impedance and the modulator tube as the variable impedance in parallel, both being supplied with power through the common impedance L_1 . Without this impedance practically no variations in the audio frequency voltage across the $b+$ and $b-$ terminals could occur. The impedance of L_1 is usually high for the average speech frequency of 800 cycles per second, in comparison with the impedance given by the ratio of the direct voltage across the $b+$ and $b-$ terminals to the direct-current constituent flowing through the choke coil. Choke coils for this purpose are usually built with an air gap in the magnetic circuit and with a large number of direct-current ampere turns per unit length of the magnetic circuit.

To the left of the modulator unit is the direct-power supply unit. In this case it consists of a direct-current generator provided with a filter circuit to prevent voltage due to commutation from existing across the terminals $B+$ and $B-$.

To summarize, tracing from left to right, the primary power supply to the set is direct power delivered at the $B+$ and $B-$ terminals of the modulator unit. By an audio frequency variation of the modulator tube impedance, audio power is produced and, together with direct power, is supplied to the $b+$ and $b-$ input terminals of the generator unit. As a result, the amplitude of the radio frequency output current of the generator unit is varied at speech frequencies and a wave form emitted, which upon reception gives rise again to speech currents.

In Fig. 3 is shown a circuit in which the Heising system of modulation is applied to a Colpitts generating circuit. The radio frequency choke L_2 of this circuit serves the same useful purpose as the capacity C_1 of Fig. 2, that is, it blocks off the modulator circuit to high frequency currents originating in the generator circuit and at the same time permits audio frequency current variations to flow. Like that of previously mentioned radio frequency chokes, its value for frequencies commonly used should approximate three millihenries and negligible intrinsic capacity. The audio choke, L_3 , should have a value of 2 to 6 henries.

It will be observed in Figs. 1, 2 and 3, that a small battery is placed in the grid circuit of the modulator tubes. The negative side of this battery is connected to the grid through the secondary of the modulation transformer. The capacity grid-leak resistance method of maintaining a negative potential cannot be used here as in the case with an oscillating tube.

In the circuits explained above, the secondary of the modulation transformer is directly in series with the grid. The instantaneous grid potential with reference to its operating point as determined by the grid battery then is dependent upon the ratio of turns in primary and secondary, and the rate of change of current in the primary. If the potential variations thus produced on the grid are excessive or insufficient, poor modulation will result.

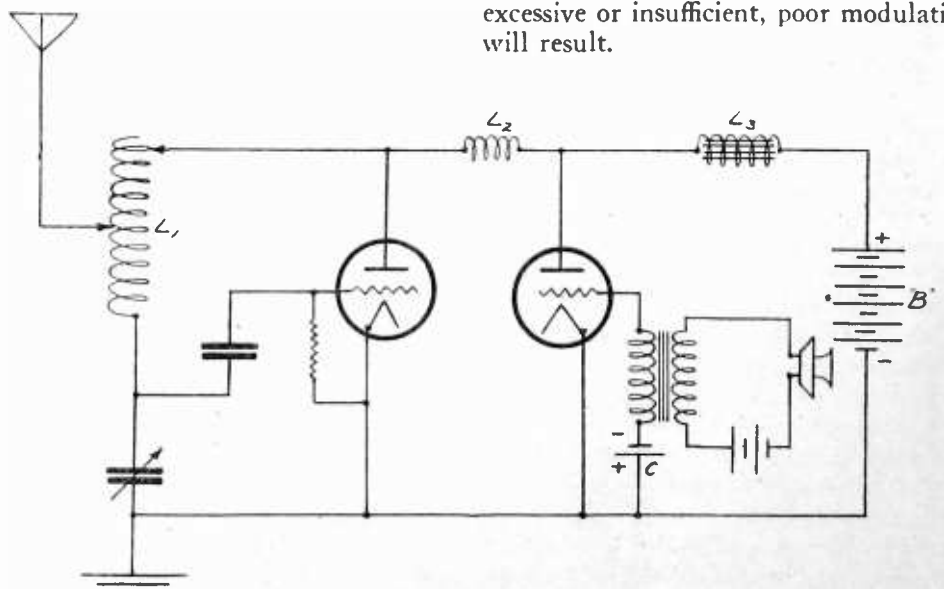

Fig. 3. Heising Modulation Applied to Colpitts Generator.

A Good Short-Wave Receiver

Using Tube Capacity for Feedback and Tuned Plate Circuit to Control Oscillation

By Frank C. Jones

MOST short wave receivers recently described use a fixed or movable tickler coil to obtain oscillations. The receiver described in this paper makes use of a very old circuit in which the internal capacity of the detector tube is used to obtain feedback and a tuned plate circuit to control oscillation or regeneration.

The advantages of such an arrangement are several, one being that the two controls are variable condensers, so that very smooth and easy tuning is obtained and no wobbly tickler control on a moving coil is needed. The losses of such a tuner can be made a minimum, since the "tickler" or plate coil is separated from the grid coil by several inches and entirely out of the field of the grid coil. Then by having the primary or antenna coupling coil several inches away from this grid coil, the latter can be entirely isolated so that dielectric losses are cut down. In the ordinary short wave tuner the tickler or plate coil is generally quite close to the grid coil and losses are introduced into that circuit where losses should be avoided.

The type of receiver described has been in use at station 6AJF for about a year and is used on all amateur bands except the $\frac{3}{4}$ meter band and has always given fine satisfaction. A similar receiver was used extensively in 5 and 6 meter tests made last spring at 6XM and 6AJF and was the only one which was really sensitive and easy to tune, which means a lot on the shorter waves.

The tuning on all of the bands is spread over a large portion of the dials making it especially easy to pick up and hold those extremely sharp and weak stations whose signals sometimes waver badly. The time required to change from one band to another is only a few seconds as it merely means clipping in the two proper sized coils. The circuit using 201A tubes has proven to be a

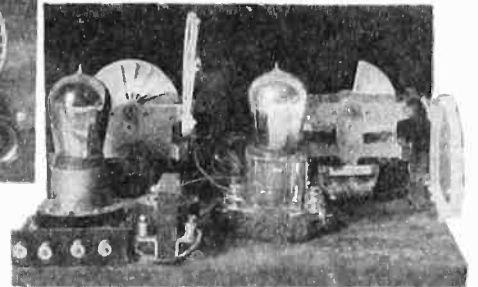
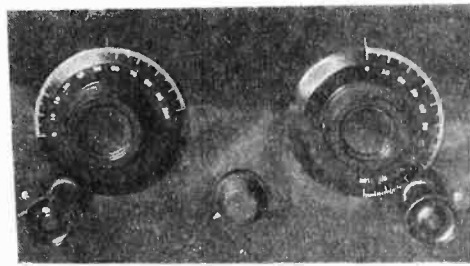

Views of Short Wave Receiver

very good oscillator, the detector oscillating nicely on 80 meters with the plate battery tap clipped into the filament battery only 2 volts from the negative side.

The pictures show most of the details and as such short wave tuners are generally made up from available condensers and parts, no panel specifications will be given except that a 7x12 in. hard rubber panel was used. The two variable condensers are Cardwell 11 plate type with all but three plates of the secondary condenser removed. This latter condenser also has the end plates cut away as much as possible by drilling and sawing so as to obtain a very low minimum capacity which is a very desirable feature in the secondary condenser. All but two fixed and one movable plate were cut out and the latter was also trimmed to give more even wavelength change along the dial. The two remaining fixed plates were spread apart with a screw-driver until nearly double spacing resulted; then by using a 4-in. dial and a 30 or 40 to 1 ratio vernier (tiny turn type) on the dial, good tuning results on all of the amateur bands, with a lap over on both sides of these bands for the particular coils being used.

The grid condenser and leak should be of the best if a quiet receiver is desired a 2-megohm leak and a .00025 mfd. grid condenser being generally suitable values. The detector tube socket is all glass and so losses are at a minimum and to prevent ringing on the shorter waves, rubber pads are used under the tube sockets. On shorter waves any vibration or jarring causes the detector tube to give a ringing sound which is very annoying but these rubber pads made from rubber sponges entirely eliminate this trouble. The sockets are bolted to the pads by short machine screws and then the pads fastened down with screws and washers in such a way that the socket rests only on the springy rubber. In order to further carry out this idea, all wiring to the sockets is of flexible wire.

The plate condenser has about .0002 mfd. capacitance and also has a 4 in. dial control and tiny turn vernier, though this fine a control is hardly necessary. The by-pass condenser should connect directly across to the filament as shown in the wiring diagram and a small radio frequency choke inserted as shown because the audio frequency transformer does not choke back the r. f. currents very well on the extremely short waves. Basket weave winding of about 30 turns wound by means of 7 finishing nails set in a $\frac{3}{4}$ in. circle makes a very satisfactory choke. The step of audio frequency amplification can be added if desired.

The coils are clipped onto the back of the condensers by means of small clips or binding posts so these leads are very short. The coils are made of No. 16 d. c. c. wire space wound by the use of knotted strings. The coil form is made with about a dozen pegs set in a 3 in. circle and the wire wound rather loosely around these pegs after which strings are started at the bottom of the coil in about 5 or 6 places. A simple knot is tied around each turn until the complete coil is tied in this manner and a very rigid job will result. About the best scheme is to wind up a set of coils starting with two turns, the next four, six and so on and in this way a sufficient number of coils will be made to cover all the wavelengths for both the grid and plate circuits. On twenty meters a two turn plate coil and a four turn grid coil work very well and a four or six turn plate coil with a nine turn grid coil covers the forty meter region excellently.

This type of receiver if well built will give very good satisfaction. In less than an hour and a half one evening in mid-summer, amateurs in every continent except Africa were copied, which is rather a difficult feat through summer static.

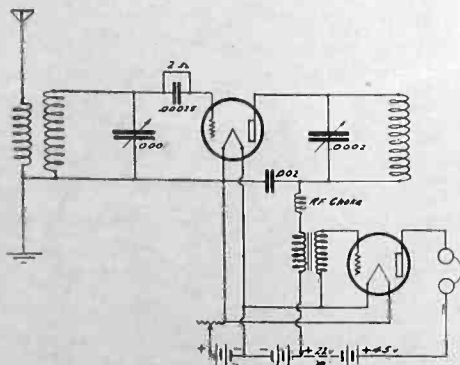

Diagram of Connections

Radio In Australasia

A Comprehensive Survey of Radio Conditions in Australia and New Zealand

By Ivan M. Levy

IT IS not generally known in the United States that the name Australasia, applies to both the Commonwealth of Australia and the Dominion of New Zealand, although both lands are governed by distinct Parliaments, and are under the British flag.

In Australia there are now about 75,000 registered radiocast listeners, and seven really first-class radiocast stations. The radio trade has not yet reached the saturation point, although owing to the large number of traders, business has slackened a good deal. The Queensland Government has installed a good 500-watt station in Brisbane, as a temporary outfit, until their 5,000-watt station is on the air, and it should be in operation about December. The Government is going to install a relay station further north so that the state of Queensland will be fairly well served within a few months.

In Sydney the major station is Messrs Farmer & Co.'s 2FC, 5,000 watts, very efficiently operated by Amalgamated Wireless, Ltd., which is an offshoot of the Marconi Company of Great Britain. This station still works on 1,100 meters wave-length, much to the disapproval of a large number of listeners for it means that many receivers cannot pick up the transmission, being built for wavelengths under 600 meters. 2FC is heard loudly in New Zealand with a four-valve receiver, embracing one stage of radio frequency and two stages of audio. Another Sydney station, Broadcasters Ltd., 2BL, has just moved its transmitter and aerial to the sea-side suburb of Coogee, and although operating with only 1,500 watts input, is heard in New Zealand with greater strength than 2FC. The wave-length of 2BL is 353 meters, and this quite evidently accounts for the greater range of that station as compared with 2FC on the higher wavelength. A smaller "trade" station in Sydney, 2UE, is also heard in New Zealand with the more sensitive types of receivers.

In Melbourne the "big" station is also a trade concern, 3LO, which is operating on 370 meters with 5,000 watts. Like the above-mentioned stations it is on the air night and day. I should mention that all the Australian stations pay for their performers and put out fine programmes, including band items, musical and dramatic plays, in some instances, right from the theatres. The proprietors of these stations receive a large percentage of the listeners' li-

cence fees from the Commonwealth Government. Another Melbourne station, run by the "trade" is 3AR, which is now on the air with 5,000 watts, on a wavelength of 484 meters. It also affords entertainment for New Zealanders.

Adelaide has now a very fine station, 5CL, operating with something over 5,000 watts input, on a wavelength of 395 meters. This station is heard in New Zealand as loudly as any Australian station although about 2,000 miles away. A smaller station in Adelaide, and another in Hobart are picked up by some New Zealanders quite well. I have heard both at times when the atmospheric conditions are favorable.

Perth, Western Australia, has a fairly good station, 6WF, operating on 1,250 meters, under the ownership of a "trade" concern. There are consistent rumors that this station as well as the Sydney station 2FC will reduce their wavelengths below 500 meters, in view of the success attained by 3LO, Melbourne, which, when formerly operating on 1,720 meters, could not reach a quarter the distance that it now does since reducing the wavelength.

American neutrodyne sets are still gaining in popularity in Australia and New Zealand, and the same may be said of the American reflex receivers. The one disadvantage of these two receivers is that they do not tune high enough to take in those Australian stations that persist on remaining above a thousand meters, but there is so much entertainment to be obtained from the other Australian stations that most purchasers are quite satisfied. Many Australian companies are building their own receivers, and by far the most popular parts are American, despite the excellence of some of the English parts now being marketed. The popularity of the American tubes has also induced the English and Continental tube manufacturers to turn out tubes with American bases, despite the proverbial conservatism of the English manufacturers. Within a few months the Australian Customs tariff on American tubes is to be raised to 40%, instead of the existing 10%. As a matter of business policy the Australians are importing huge quantities of American tubes for quick delivery in order to get in big stocks before the door is closed. This increase in Customs duty does not affect New Zealand, which is quite independent of Australia. Both in Australia and New Zealand the

prices of tubes have come down from about six dollars to four dollars and a quarter for all American Radiotrons and DeForest tubes of the detector and amplifier types. The British tubes are sold from 85 cents up to nine dollars. The lower-priced English tubes are fitted with English bases and have the following characteristics—filament volts .4; filament amps. .5; plate volts 30 to 100; for use either as detector or amplifier.

New Zealand radiocasting is in the throes of transition. The New Zealand Government has let a contract to a New Zealand Company known as the Radio Broadcasting Company of N. Z., with a capital of £20,000 to erect and operate the radiocast stations of this country. The company is to receive twenty-five shillings out of every thirty shillings received by the Government for license fees from listeners—from amateur transmitters, and a substantial proportion of the fees charged for traders' licenses. The company is to have two stations erected and in operation sometime next March, one station to be in Auckland and the other in Christchurch. They are to be restricted in output to 500 watts and just why the Government has put such a ridiculous restriction is beyond comprehension. The stations mentioned above are about 450 miles apart, and as static, like the poor, is always with us, reception frequently will be far from perfect for those who reside over a hundred miles away from either of these stations. According to statements made in official circles it is feared that stations of more than 500 watts output are likely to interfere with ship to shore telegraph communication. Hence the restriction! Under conditions of their contract the Government reserve the right to require the new company to erect a similar station at Dunedin and at Wellington, by giving notice to the company when its first two stations are on the air.

In the meanwhile the new company is also required to take over the existing radiocast stations conducted by various groups of the radio "trade," at a valuation to be agreed upon by both parties, and in the event of a disagreement the Government Chief Telegraph Engineer is to act as arbiter and his valuation is to be binding on the new company. Unfortunately for Wellington the owners of the existing station have not agreed to the price offered by the new company, and have declined to accept the arbiter's

(Continued on Page 72)

Radio as an Aid in Recording Earthquakes

An Interesting Account of How Radio Time Signals are Received and Automatically Recorded

By G. M. Best

THE recent series of earthquakes in the Eastern and Northwest portions of the United States has brought general attention to the fact that such disturbances are likely to occur in almost any section of the country, and are not confined to certain small areas. Consequently the public interest in seismology, the scientific study of earthquakes, has greatly increased in recent months on account of various newspaper articles about earthquake location and prediction. So a short description of a unique use of radio in aiding this study will no doubt interest the radio fraternity.

The principal instrument used in the study of earthquakes is the seismograph, a sensitive instrument for recording the faintest earth tremors. The apparatus is usually mounted on a heavy concrete base in the basement of a building located as far away from city traffic as is possible, due to the interference caused by moving vehicles.

At the Mt. Wilson Observatory laboratory, at Pasadena, California, is installed a new type of seismograph, known as the torsion seismometer, which records the horizontal component of the earth's motion. Previous models recorded the vibrations on a smoked chart rotated on a drum actuated by a clock-work mechanism. But in this model a beam of light is reflected by a mirror at-

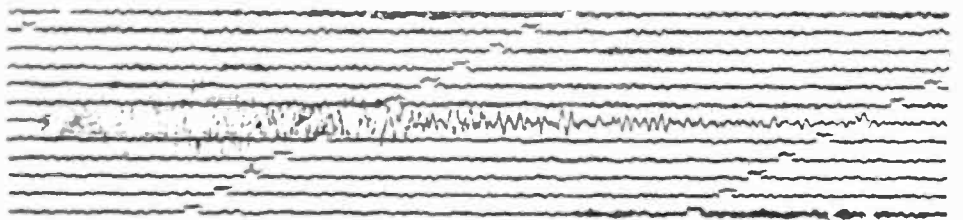

Fig. 1. Record of Local Earthquake on Seismograph.

tached to the seismometer so as to affect a piece of sensitized photographic paper mounted on the revolving drum. Whenever earth tremors occur, this mirror swings back and forth horizontally, and the beam of light exposes portions of the photographic paper to form a continuous wavy line, which appears in black on a white background, as is shown in Fig. 1.

This illustration shows a small portion of the chart over a period during which a slight local earthquake was recorded, and the sharp, irregular lines indicate the horizontal motion of the earth during the tremor. An additional seismograph is required if the vertical motion of the earth during a quake is desired. The series of humps in the wavy lines seen at regular intervals are caused by a clock which transmits an electrical impulse each minute, to the seismograph, and thus permits a record of the exact time at which an earthquake has occurred. Hence it can be seen that the earthquake recorded had a duration of approximately one minute, and since it

is known exactly what time the chart was placed on the drum, the humps in the line can be counted until the earthquake record is reached, and the exact minute and second of the tremor computed.

Any form of chronometer, no matter how well made, is bound to have some form of error, and it was with the idea of correcting this error that an apparatus for recording radio-transmitted time signals from various government observatories was constructed, and placed in successful operation. The essential parts of the time signal recorder are shown in the schematic diagram in Fig. 2.

The radio signals are received from the various long wave, high power telegraph transmitting stations, such as NPG, Mare Island; NPL, San Diego, and NSS at Annapolis by a three circuit tuner employing honeycomb coils, and are converted to 1000 cycle frequency in the detector circuit. A two stage audio frequency amplifier having high ratio

(Continued on Page 75)

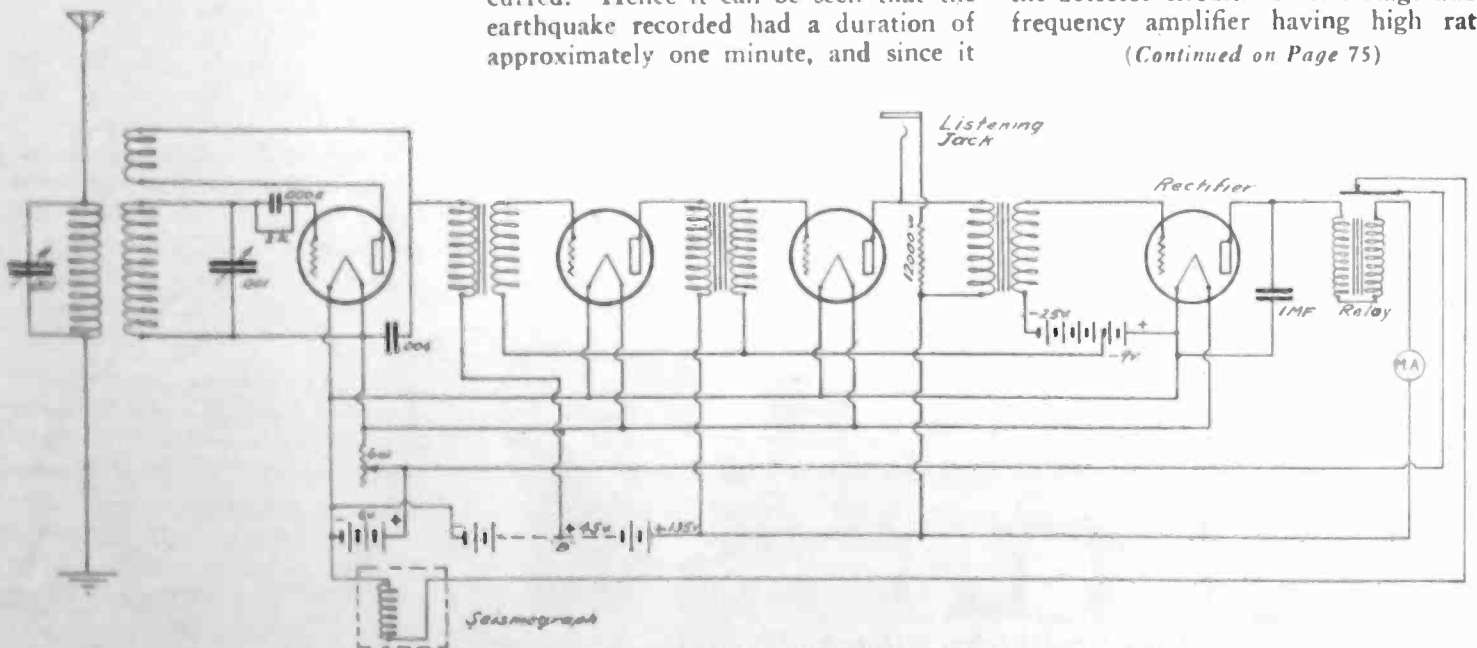

Fig. 2. Diagram of Time Signal Recorder.

Radio In The Fiji Islands

A Graphic Account of Successful Radio Reception on a Far Away Isle

IMAGINE living on an island in the middle of the Pacific Ocean, and depending upon radio stations from four to six thousand miles distant for your evening's entertainment. Picture yourself, if you will, by a thatched roof house on a hill above the sea, with the radio set and loud speaker on the lawn, of a warm winter's evening, enjoying yourself by listening to Jerry Anderson singing "I'm So Ashamed" from WQJ in Chicago, or to the Little Symphony Orchestra from KGO in Oakland.

Such is the regular custom of Rev. Richard Piper, in charge of the Methodist Indian Mission at Lautoka, Fiji Islands, and his account of how he accomplishes this feat with an 8-tube Best Superheterodyne is a tale of long weeks of painstaking work, with inadequate tools and all sorts of makeshift apparatus.

Having obtained a copy of the May 1924 issue of RADIO, Rev. Piper proceeded to assemble the 45,000 cycle Superheterodyne described therein, for use with a loop antenna. The special apparatus such as the intermediate frequency transformers, oscillator coupler and the like had to be ordered from America, and after a long wait, the material arrived. Early last spring the set was placed in successful operation, the complete assembly being shown in the pictures. Rev. Piper's "assistant engineer" is seen standing to the left of the loop antenna, and we are assured that he is very adept at wiring and builds fine radio cabinets out of rare native woods. Not having a 6 volt C battery available, Mrs. Piper was persuaded to part with her flashlight for a few weeks, and the batteries therefrom comprise the imposing array of dry cells at the rear of the baseboard.

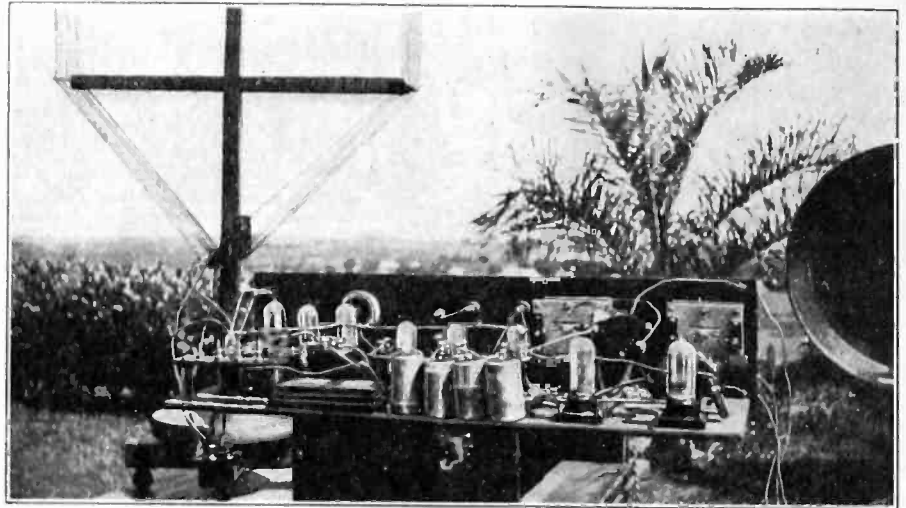

Closeup of Set, Showing Mammoth "C" Batteries

Almost immediately after the set was turned on, signals from KGO, 4500 miles away, were picked up with the loop antenna, and soon the entire native population was being entertained with jazz from the land of the "Charleston." A customary evening's reception begins about 5 P. M., when the carrier waves from U. S. stations are picked up, and by 5:30 the program from KGO are plainly audible. From then on until 6:10 P. M. the sun drops very rapidly and signals come up to maximum strength so that stations such as KFI, KNX, and KHJ in Los Angeles, CFCN in Calgary, and WQJ, WEBH, WDAF, KOA and other stations east of the Rockies are heard with loud speaker volume.

Due to trouble this summer with terrific static which infests the tropics, it was decided to try an underground antenna, so a No. 8 insulated wire was buried under the bungalow and down

the side of the hill to a total length of 200 ft., the wire being pointed in the compass direction of KGO. With an antenna tuner consisting of a variocoupler, with loading coil and series air condenser in the antenna circuit, satisfactory programs practically free from static were had throughout the static season. A special antenna tuner for receiving the Australian 1100 meter stations was also constructed and with it Station 2FC in Sydney is received daily. Press dispatches from this station as well as those from U. S. stations are copied, as Mr. Piper furnishes all the news for the local newspaper, which is published by the sugar company of the island. The method of tuning for 1100 meters is novel, and may be of interest to those fans who desire to increase the wavelength range of their supers. The antenna coil consisted of an aperiodic primary of 20 turns of No. 20 d. c. c. wire, wound on a 2 in. tube, placed inside the secondary coil, which consists of 150 turns of No. 24 d. c. c. wire wound on a 3 in. tube. A .001 mfd. fixed condenser is placed in shunt with the oscillator condenser, and the plate voltage of the oscillator tube increased to 70 volts, as with 45 volts the oscillator will not function with such a large condenser in the circuit.

Mr. Piper is now engaged in constructing a shielded model superheterodyne, for use with the underground antenna, and with the short wave tuning apparatus and oscillator coil system used in this model, he will undoubtedly be able to hear the 62 meter transmission from KDKA in Pittsburg, a distance of 7000 miles from Fiji.

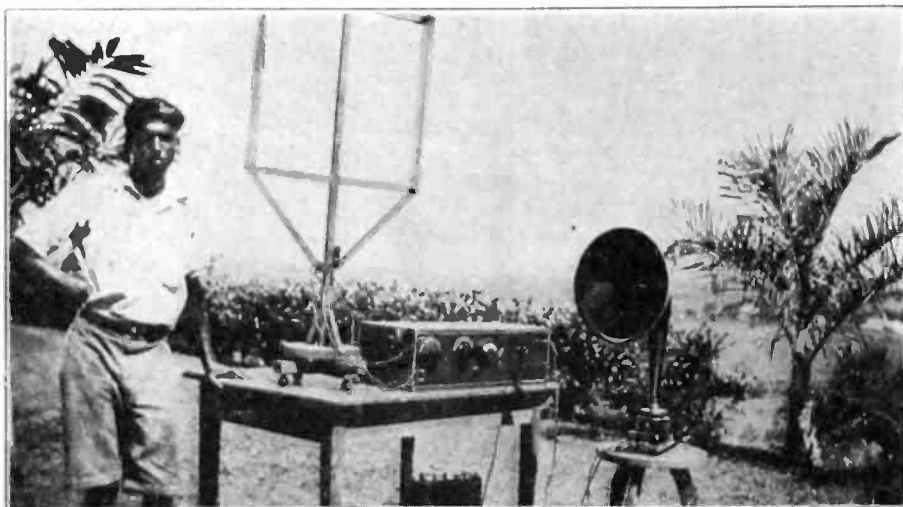

A Best Superheterodyne at Lautoka, Fiji.

An Improved Multi-Wave Receiver

Constructional Hints for a Receiver for Use on Short or Long Waves

By Willis L. Nye

THE present assignments for radio-cast or amateur transmission are scattered over a very wide band of frequencies and the ability to receive on all these waves calls for a receiver having a wide frequency range.

The question of the best circuit to use is not one of lengthy thought, because

control condensers are mounted on the panel, the same applying to the rheostat, verniers, jack and filament switch. The two tuning inductances are mounted to the extreme left of the sub-panel with all leads parallel and leading to the wavelength change switch. The switch should be mounted on the bakelite sub-

- LIST OF PARTS**
- 1 Bakelite panel 8x13x $\frac{3}{8}$ in.
 - 1 Bakelite panel 9x13x $\frac{3}{8}$ in.
 - 2 .00025 mfd. Condensers with geared vernier.
 - 2 vacuum tube sockets.
 - 1 grid condenser with gridleak attached.
 - 1 30 ohm rheostat.
 - 1 large 4 in. dial with vernier gear.
 - 2 small 2 $\frac{3}{4}$ in. dials.
 - 1 phone jack.
 - 6 binding posts.
 - 4 feet of 3/32 in. strip brass, $\frac{1}{2}$ in. wide.
 - 1 double pole, double throw switch.
 - 1 home wound choke coil.
 - 1 .0005 phone condenser for by-pass purposes.
 - 1 Bremer-Tully Short Wave Tuner, 50 to 150 meters.
 - 1 Bremer-Tully long wave tuner, 200 to 550 meters.
 - 1 audio transformer.
 - 6 Carter phone tip jacks.
 - 1 filament switch.
 - Necessary screws, spaghetti, bus-bar, etc.

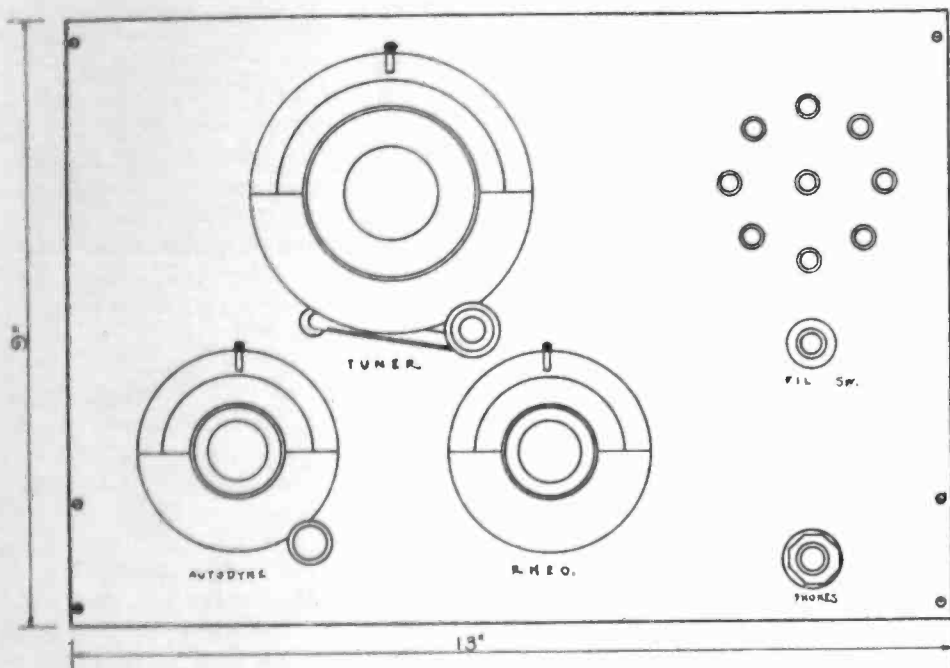

Fig. 1. Panel Layout.

panel and not on the porcelain base ordinarily provided with the switch, unless special switches with bakelite bases can be obtained. Each switch has a lead making contact to a phone tip jack, so that smaller or larger coils than those already installed may be connected to cover waves above or below the present range. It will only be necessary to connect one set of the phone tip jacks to each switch.

The sockets are mounted near the panel next to the edge of the sub-panel,

the experimenter has a choice of a number of circuits, including the Hartley-Reinartz and the Armstrong three circuit regenerative. As far as is known, these two circuits have proved to be among the best for short and long waves. Each has its advantages and the choice of the circuit will be left to the constructor, although the Hartley-Reinartz circuit will be described here. Practically the same hints apply to both circuits, whichever one is chosen.

The panel layout should be as shown in Fig. 1. The holes for the various pieces of panel mounted apparatus will be given by the manufacturer of the parts purchased and they may be drilled to suit from the template given. It will be of advantage to place the parts in a manner similar to Fig. 1, saving the builder a lot of proportioning of apparatus.

The general plan of the receiver is shown in Fig. 2, enabling the constructor to obtain an idea of the arrangement of baseboard apparatus. The exact dimensions of each piece of apparatus, and their location, are left to the builder, although the approximate distances are given for the sake of convenience. It will be noticed that the grid and plate

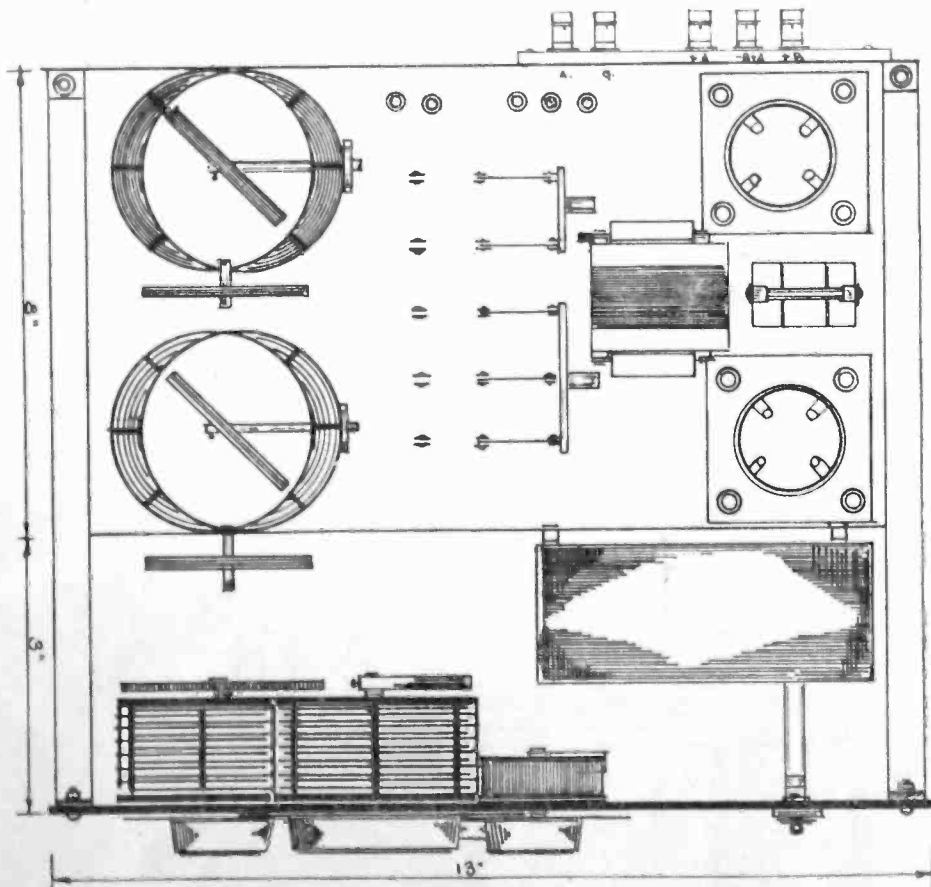

Fig. 2. Assembly Details.

the choke coil being mounted to the rear of the audio transformer and the sockets at right angles to the tuners. The choke coil is wound on a 2 in. form, has 250 turns of No. 28 d. c. c. wire and should be kept as far from the tuners as is possible. The audio transformer may be mounted between the two vacuum tube sockets.

The two Bremer-Tully tuners should next be screwed to the sub-panel to the rear of the condensers, the short wave tuner being mounted as close to the variable condensers as is possible. The radio-cast tuner may be mounted at the rear edge of the sub-panel. Mount all the tuners so that the ticklers and primary coils may be adjusted for their relative

mounted on the sub-panel and these are to be used when coils are used to obtain a range different than obtainable with the existing tuners. Such coils may be wound of a heavy gauge wire so they are self supporting.

The range of the receiver is roughly from 550 meters down to 40 meters or less, if the smaller coils are used. To reach 40 meters the tuner will have to be tapped at the 7th turn for the filament return. The usual range on the short wave tuner is from 56 to 150 meters. To reach to 200 meters a 250 mmf. fixed condenser is shunted across the leads. To obtain a wavelength range of 600 meters the same condenser is shunted across the long wave tuner.

THE REGENO-NEUT.

By CARLOS S. MUNDT

THE neutrodyne receiver, as developed by Prof. Hazeltine, has always been a very popular form of radio receiver. Its relative ease of operation, quietness, excellent tone quality and general dependability have commended it to many. Besides, the principle of neutralization has been seen to be a very useful one, so that it has been applied to receivers of different design.

The vacuum tube is a voltage operated device. Any voltage oscillations impressed on the grid circuit give rise to resulting variations in the plate current and hence to corresponding variations in the telephone currents. However, its sensitiveness may be enormously increased, by feeding back some of the energy of the plate oscillations to the grid circuit, whose own oscillations are thereby able to produce still larger variations in the plate current, thus giving a greater current response in the telephone receivers. Such response is of course far greater in value than would have been obtained from the original oscillations in the circuit.

This method of "feeding back" energy from plate to grid is called "regeneration" and is really an amplifying action, taking place while detector action is going on. It has been often called "self amplification" because of this, amounting as it does to the use of the detector tube for a double purpose.

The neutrodyne owner of experimental trend may derive considerable benefit from the application of regeneration to his receiver. While it is true that this may mean the addition of another control and greater operating care the results may be well worth while, resulting as they do in considerably amplified signals.

There are several methods of obtaining the desired feedback, the simplest of which takes the form of a variometer inserted in the plate circuit of the detector tube, producing coupling to the grid itself via the tube. Variometers, however, because of their high losses due to distributed capacity will scarcely be favored in this era of strictly "low loss" construction.

There remain two other methods, described as follows:

(1) The addition of a tickler coil to the grid tuning element just preceding the detector. In some receivers this may be accomplished by winding on a small form about 20 turns of No. 22 d. s. c. wire and placing it in variable inductive relation to the grid coil. In other sets the builder may wish to remove the detector tuning element and insert an entirely new one in its place, containing of course the necessary feedback coil, or tickler. Fig. 1 shows the arrangement of this form.

(Continued on Page 46)

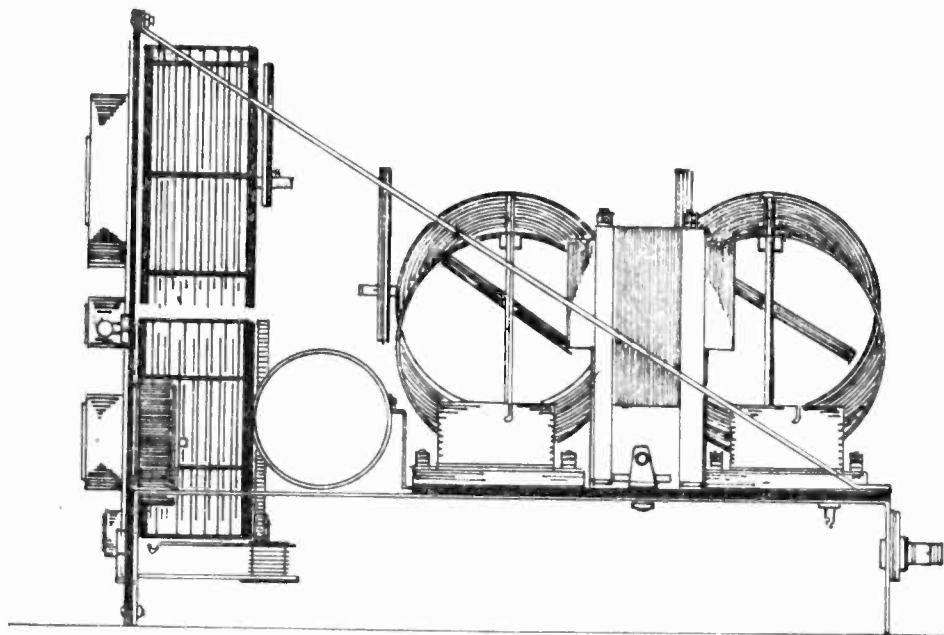

Fig. 3. Side Assembly.

distances from the secondaries, after which the set screw may be tightened so that they will be permanent. Once the proper settings are found, they need not be touched again. The grid condenser and leak should be mounted near the detector tube. The audio transformer should have a medium amplification ratio so that the quality of broadcast will not be below the usual standard. This will also be satisfactory for the short waves.

A by-pass condenser will be of much value in the B battery circuit, as shown in the circuit diagram, Fig. 4. The phone tip jacks are shown in Fig. 2,

Thin shellac, if applied to slightly warmed metal surfaces, will serve as quite satisfactory metal lacquer. It is best put on with a camel's hair brush.

In making up a ground connection, a couple of old "bath boilers" buried in permanently moist earth will often give good results. They should be well cleaned of all paint, and grease, before burying, however.

The common black paint sold as "asphalt roof paint" will be found to be quite satisfactory as an acid proof paint.

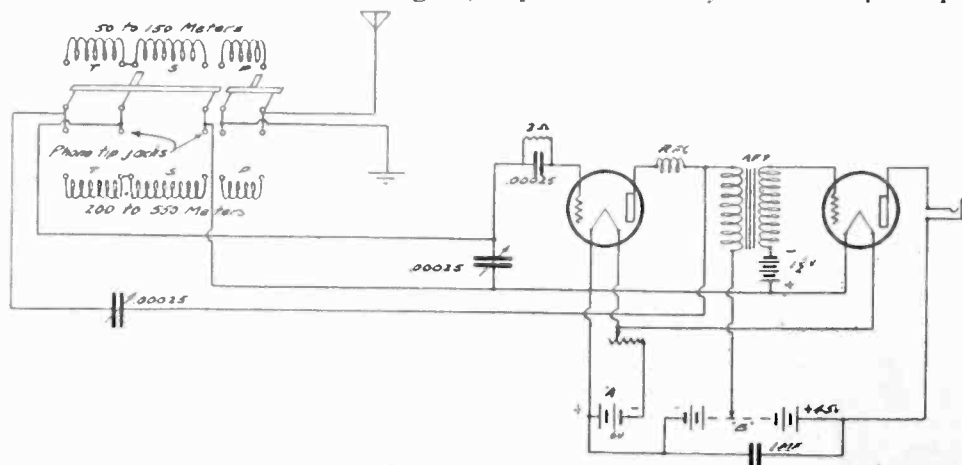

Fig. 4. Schematic Wiring Diagram.



QUERIES *and* REPLIES



Questions submitted for answer in this department should be typewritten or in ink, written on one side of the paper. All answers of general interest will be published. Readers are invited to use this service without charge, except that 25c per question should be forwarded when personal answer by mail is wanted.

I wish to build a Browning Drake circuit, using Canadian peanut tubes, with UX-112 tube in the power stage. Please show how the filaments of the peanut tubes may be operated in series from a six volt storage battery.—R. L. R., Rochester, N. Y.

The circuit you wish is shown in Fig. 1. C potentials for the various tubes are ob-

shown revised so as to accommodate four 5 watt tubes, with inductively coupled antenna system. For C. W., the buzzer system can be employed by cutting out the microphone, and where I. C. W. is to be used, the two modulator tubes can be placed in parallel with the oscillators by connecting the grids as shown and short-circuiting the r. f. choke in the modulator plate circuit.

If you are satisfied with your present arrangement and do not care about the short waves, no particular advantage would be gained by rebuilding your set. The resistance coupled amplifier, if properly constructed, will equal in amplification the output of your present transformer coupled amplifier.

Does an aerial deteriorate by being in use for 3 years in an exposed position?—H. N. R., Ladner, B. C., Canada.

Unless the antenna wire is enameled with a good grade of material, it will corrode quite noticeably in 3 years, and will be coated with a layer of oxide. It is doubtful, however, whether you will notice much difference in the reception of stations, over that obtained with a new piece of wire.

Kindly publish what changes are necessary in the four tube LC receiver in order to use .0005 mfd. variable condensers instead of .00035 mfd. as specified in the article in October RADIO.—W. J. H., San Francisco, Calif.

The antenna inductance coil should have a total of 58 turns of No. 20 bare copper wire, with a tap at the 7th turn for the antenna. The r. f. transformer should consist of three sections of 17 turns each. No other changes will be necessary when using .0005 mfd. tuning condensers.

The current supply set described in June 1924 RADIO doesn't give very good results on the second stage of my 5 tube Kennedy. The receiver has a C battery and variable resistance for the detector current. Would the Raytheon tube described in November RADIO work in this device?—U. L., Sacramento, Calif.

The Raytheon tube will require a higher voltage than that provided by the transformer which you now have. If you will re-wind your power transformer according

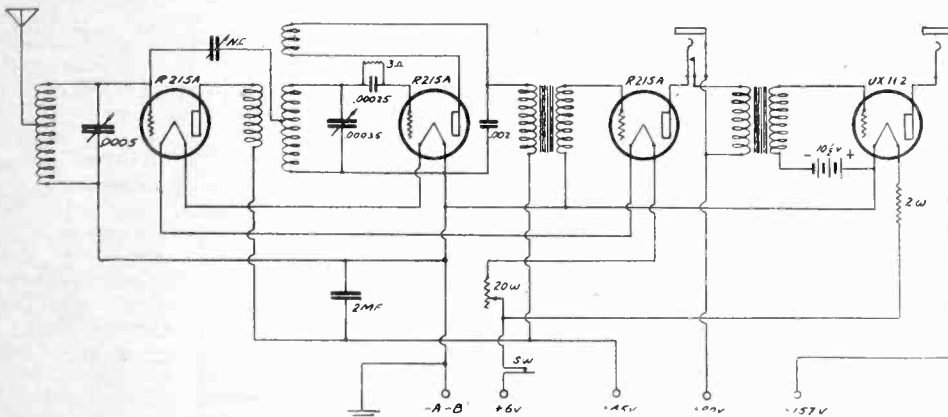

Fig. 1. Browning-Drake Circuit With Series Filaments.

tained by the voltage drop across the filament circuit. If a C voltage greater than 2.2 volts is desired, for any of the peanut tubes, a dry cell battery will be required.

My present 10-watt radiophone has a conductively coupled antenna tuner and would like to change this into an inductively coupled circuit, with four 5 watt tubes instead of two. Please show how the set can be used for C. W., I. C. W. and phone.—T. B. S., Santa Barbara, Calif.

In Fig. 2 your present transmitter is

As you do not state the wavelengths to be covered by the set, no data for the inductance coils or tuning condensers is given.

Have an 8 tube Best Superheterodyne built according to a diagram in Nov. 1924 RADIO. Would there be any advantage in changing to the circuit shown in Sept. 1925 RADIO, other than the privilege of tuning in the short waves? Would three stages of resistance coupled amplification improve quality of reception and give same volume as two stages of transformer coupled audio?—A. L., Oakland, Calif.



Fig. 2. Circuit of 10-watt Transmitter

to the data given in the article on Page 35 of November RADIO, you will have the proper secondary voltage to operate the Raytheon tube. If you are not obtaining satisfactory results from your present outfit, the rectifier tubes may have lost their filament activity, and should be rejuvenated. One of the new UX-213-CX-313 rectifier tubes will take the place of the two A tubes you are now using, and will not require a higher transformer voltage.

Kindly publish information for building the external oscillator for use with the Superheterodyne described in September RADIO, for receiving amateur C. W. signals. In my set, have placed my filter coil ahead of the intermediate frequency amplifier. Would it make any difference if this coil was placed just ahead of the detector tube, as is usually done?—C. L. B., Kerry, Ore.

In Fig. 3 is shown the diagram of the

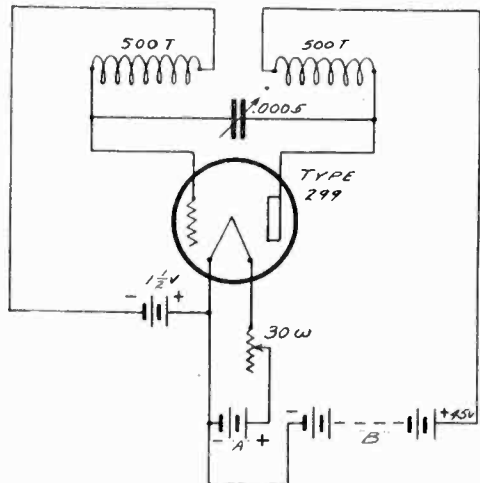

Fig. 3. Separate Oscillator for Superheterodyne.

beating oscillator necessary for amateur C. W. reception. The oscillator coils consist of two 500 turn honeycomb coils placed close together, taping them in position with friction tape so as to have maximum coupling. When tuned with a .0005 mfd. condenser, the range of these coils will probably be from 60 kilocycles down to about 30 kilocycles. Assuming that the intermediate frequency amplifier is tuned to 45 kilocycles, it will only be necessary to set the beating oscillator about either 44 or 46 kilocycles, and a 1000 cycle beat note will be obtained on C. W. signals. No coupling between the beating oscillator and the radio receiver is necessary, as an adequate amount of energy will be transferred through the filament circuit, which should be common to both the oscillator and the radio set.

Have built a Best Superheterodyne with type 299 tubes, using Remler apparatus. The loop dial tunes broadly and the feedback condenser is too critical. The audio amplifier has tendency to howl on distant stations. What could be done to cure the trouble? Could this set be made to operate with 201-A tubes? Could better results be obtained with A tubes for the detector and two audio stages? Would the combination of A and 299 tubes as shown in September RADIO be the best? What would be the best antenna booster to use? What changes in grid leaks should be made if the tubes are changed?—H. S. C., Compton, Calif.

If the loop tunes very broadly, it is either wound with too fine wire and is of high effective resistance, or there is a high resistance connection in the loop circuit. The feedback condenser should have some of the movable plates removed, as it appears to have too much capacity at present. Shunting the secondaries of the two audio frequency transformers with 1/2 megohm grid-

leaks will help reduce the tendency of the amplifier to howl. If only two intermediate stages are used, the set can be made to work satisfactorily, without trouble from oscillation, using all 201-A tubes. The use of A tubes in the detector and audio stages will increase the power output of the set, but will make very little difference in the sensitivity. The combination of type 299 tubes in the intermediate stages and A tubes in the other sockets, as shown in the Superheterodyne described in September RADIO, is the best arrangement where a storage battery is available and a supply of A tubes is already on hand. An antenna tuner as shown in Fig 4 is a very simple and selective booster for a loop set. Place the loading coil and condenser in series between the antenna and ground, and mount the coil in close proximity to the loop. The coupling coil will not be needed when the loop is used. For type 299 tubes, the grid leak resistance should be 3 megohms, but for the A tube the resistance should be reduced to 2 megohms.

Have a Best Superheterodyne, and would like to use a single wire antenna in connection with it. How may the antenna be attached?—W. S., St. Paul, Minn.

The most satisfactory combination of the antenna tuner is shown in Fig 4. This

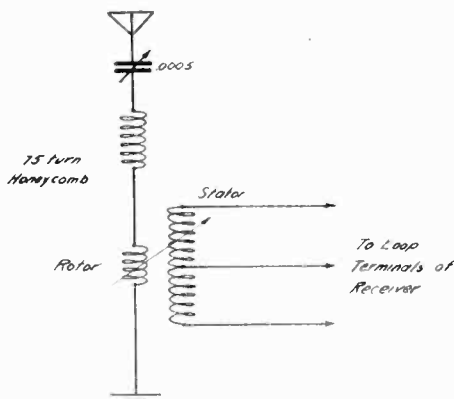

Fig. 4. Method of Connecting Antenna to Superheterodyne.

circuit has been published several times in these columns, but in view of the increasing number of questions on the tuner, it is again printed. The antenna loading coil may be either a 75 turn honeycomb coil or a coil consisting of 100 turns of No. 22 or 24 wire wound on a tube at least 3 in. in diameter. The coupling coil may be an oscillator coupler such as is used in the receiving set for the oscillator system, the rotor being connected in the antenna circuit and the stator windings used as the secondary coil, in place of the loop antenna.

Please publish a diagram for one stage of amplification.—M. R. R., Berkeley, Calif.

We cannot intelligently answer your question without knowing whether you wish a radio or audio frequency amplifier, and to what type of detector or tuned circuit the amplifier is to be added. Kindly forward this information and we will be glad to publish the diagram.

Please give me the necessary data for changing my four tube receiver so that it will operate from a 6 volt storage battery. It is a Roberts Reflex with 299 tubes, and now operates with a 3 dry cell battery, which runs down in a few days.—D. H. M., Malone, N. Y.

Assuming that your present filament rheostat is designed to limit the current of the four tubes to .24 amperes, with 4 1/2 volt A battery, a 10 ohm fixed resistance should be placed in the positive A battery lead, between the radio set and the battery. A voltmeter is a particularly handy thing to

have with 299 tubes, especially when operating them from a battery having a voltage greatly in excess of the tube operating voltage.

I have a five tube Neutrodyne which was constructed from Fada parts over a year ago. Can this set be re-wired to employ three variable condensers all mounted on one shaft?—H. B. W., Stratton, Ill.

You can now obtain a three gang variable condenser made up of three .00025 mfd. sections, with common rotor and separately insulated stator groups. It is preferable to use a condenser unit having each rotor adjustable with a set screw, so that slight variations in the inductance of the secondary coils can be taken care of. Some multi-unit condensers are equipped with an adjustable rotor plate for each rotor section.

My 8 tube superheterodyne gives satisfactory reception of distant stations, but I have trouble in tuning out a local station situated a few blocks away, and would like to know if shielding the set will help matters? The local stations come in at many places on the oscillator dial.—H. J. D., Chicago, Ill.

Shielding the back of the panel and inside of the cabinet with sheet brass of at least 20 gauge is an excellent aid in cutting out local interference. Holes should be cut in the back panel shield so that none of the metal parts of the panel apparatus will touch the shield. The entire set of shields should be connected together and permanently wired to the negative A battery, which should in turn be connected to ground. Any superheterodyne oscillator tube will emit harmonics, unless an elaborate oscillator system is employed, and up to the present time, no superheterodyne has been used commercially with anything but the ordinary variety of oscillator circuit. Hence, when the offending station is operating at say 1,000,000 cycles, which is 300 meters, and your intermediate frequency amplifier is tuned to 50,000 cycles, you can hear the station with the oscillator tube set at either 1,050,000 or 950,000 cycles. If you will adjust the oscillator so that it is operating at either 525,000 or 475,000 cycles fundamental, it will emit harmonics at 1,050,000 and 950,000; 1,575,000 and 1,425,000; and so on up to the very high frequencies, as harmonics up to the 25th have been measured with such an oscillator. Consequently, the 1st harmonic of the oscillator when set at 525,000 cycles will produce a 50,000 cycle beat note with the 1,000,000 cycle incoming signal, and you will hear the station at a point on the dial which would correspond with a wavelength near 600 meters. This is only possible when the loop tuning condenser is set at 1,000,000 cycles, for if the loop is tuned to 525,000 cycles, it is inconceivable that you would be able to hear the 1,000,000 cycle station to such an extent that it would interfere with reception at 525,000 cycles. We have received many such complaints from time to time, that the same station could be picked up at six or more places on the dials, and when the set was examined, it was found that the stations producing this phenomena were all below 250 meters, and could be picked up in many places on the oscillator dial only when the loop dial was set at the exact wave of the incoming signal. If the loop was de-tuned several degrees, the station could not be picked up at any point on the oscillator condenser.

For reducing the voltage on my homemade B eliminator from 250 to 45 volts, 18 milliamperes, I am using a carbon-pile type rheostat and at times the rheostat makes the radio set noisy, due to the large amount of power being dissipated in the carbon discs. Is there any

(Continued on Page 41)

STATION 6ZAC, TUTUILA, SAMOAN ISLANDS

6ZAC, call of Mr. Clifford J. Dow, is a reminder to the amateurs of the Pacific Coast of the days when Dow was at Wailuku, Maui, Hawaiian Islands, and where more than one distance record was established. Mr. Dow is now located at Tutuila, American Samoa, which is some 2000 miles (southwest) of Hawaii, and has re-established his station under the old call. Mr. Dow is now in the U. S. Naval Radio Service, and is attached to the Naval Radio Station at Tutuila, where he has constructed a short wave transmitter which has again placed 6ZAC on the radio map.

The equipment was built to accommodate a 250 watt G. E. tube, but the only one available went soft soon after the tests were started with it, so a 50-watt Western Electric tube was substituted.

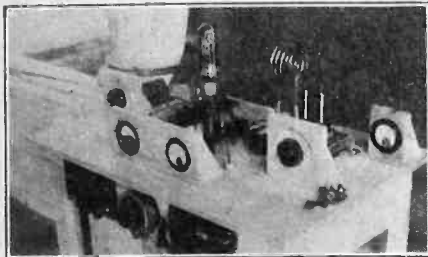

Transmitter at 6ZAC, Samoa.

The apparatus shown uses the above mentioned 50 watt tube, in a "tuned grid and plate" circuit, which has become so popular and useful on the higher frequencies. The coils for the plate and grid tuning may be interchanged to allow transmission on 20 meters, as well as on the normal 40 meter band, and these coils are wound with stiff copper tubing, which holds its shape firmly, and securely. A small coupling coil is placed within the plate coil, which couples the antenna to the plate circuit. The plate supply for the tube, is obtained from a 220 volt 500 cycle generator, which is stepped up to about 1000 volts and supplies the tube through suitable choke coils. Keying is accomplished by opening and closing the primary transformer circuit, similar to the method used for ordinary 60 cycle tube transmitters or spark equipment. The actual input to the tube is about 150 watts, which gives about 0.9 amperes on 39 meters, and about 0.7 amperes on 20 meters.

Using the above transmitter, communication has been handled with every U. S. Radio District, Cheefoo, and Tsingtao, China, NPO, Cavite, P. I., and the Naval Radio Laboratory, Bellevue, District of Columbia, which shows that the set certainly reaches out.

This same equipment is used when necessary for Naval traffic, and under such conditions it uses the call NPU. This will explain the apparent similarity between the "notes" of 6ZAC and NPU.

Mr. Dow expects to be transferred to the Naval Radio Laboratory, Bellevue, D. C., (NKF) where he will probably be assigned to experimental work in connection with the Laboratory, so it is not known for certain how long he will be working the 6ZAC station.

QUERIES AND REPLIES

(Continued from Page 40)

way to cure this trouble?—F. H. A., Bellingham, Wash.

The only sure method of reducing the voltage output of the B eliminator without such troubles is to determine the exact resistance required, which in your case is 11,388 ohms, and obtain the proper values of Ward-Leonard resistances, designed to dissipate at least 5 watts of power without undue heating.

RADIO CONFERENCE RECOMMENDATIONS ON AMATEUR MATTERS

As there was no change in the allocation of wavelengths assigned for amateur use, the conference recommended that the existing amateur regulations be continued in force, with the following minor modifications:

That the Department of Commerce no longer license the use of spark transmitters on amateur bands;

That amateur phone operation be permitted in the amateur band between 83.3 and 85.6 meters, provided such stations observe the prescribed amateur silent hours;

That a monthly supplement to the "List of Amateur Radio Stations" be published by the Department.

JEWELL 1926 RADIO CONTEST

Under the slogan of "more miles per watt" the Jewell Electrical Instrument Co. is again offering a fine watch as a trophy for the licensed amateur submitting documentary evidence of having transmitted, by radio telegraphy, the most miles per watt over a distance of 300 miles or more. This will be awarded June 1, 1926.

NEWS OF THE AMATEUR OPERATORS

6BX, A. Binneweg, Jr., 524 Fairbanks Ave., Oakland, Calif., will conduct extensive experiments on 5 meters and less from Dec. 15 to Jan. 30. He requests that amateurs interested in co-operating write immediately.

9WV had recently been re-issued to Max Colvin, 208 N. Jackson Ave., Kansas City, Mo., who is working on 40 and 80 meters with a five watt tube in an inductively coupled Hartley circuit, and would greatly appreciate any reports on reception of his signals.

NEW RADIO CATALOGS

Jewell Electric Instrument Co. of Chicago have issued a handsome description of the use of a new voltmeter intended primarily for checking the filament voltage of tubes used in some of the new sets equipped with phone tip jacks for this purpose. No. 135-A is a 2 in. diameter instrument reading 0-5 volts and equipped with special prods in the rear for plugging into the jacks. No. 135-C is a similar instrument in an attractive clock-case mounting and equipped with cords and phone tips; it has a double scale 0-7.5 and 0-150 volts.

Circular No. 735 from the Jewell Electrical Instrument Co. of Chicago, illustrates and describes their Junior Tube Tester, for determining the relative emissivity of the filament by measuring its plate current in milliamperes.

The ninth edition of the Acme Apparatus Co. instruction book on "Amplification Without Distortion," constitutes an excellent text on the basic principles of radio theory and construction. Diagrams are given for a two-stage transformer coupled audio amplifier, a three-stage impedance coupled, a four-tube reflex with loop and a B battery eliminator. National Radio Institute has issued an attractive booklet, "Rich Rewards in Radio," descriptive of their correspondence course.

Cardwell Equitrols is the subject of Bulletin No. 71 from the Allen D. Cardwell Company of Brooklyn, N. Y. This is a device whose dial gives straight line wavelength tuning with a standard condenser having semi-circular plates and devotes greater dial space to the low wavelength stations.

CALLS HEARD



SAGO-SVIE, Pittsburgh, Pa.
U. S. A.: 5aab, 5ab1, 5ac1, 5acl, 5ado, 5ado, 5adu, 5adz, 5agn, 5agq, 5agu, 5alg, 5al1, 5aln, 5akz, 5ame, 5arn, 5ask, 5asv, 5atf, 5atk, 5atp, 5atv, 5atx, 5auc, 5oo, 5gk, 5he, 5hy, 5jd, 5jf, 5lg, 5ms, 5nj, 5nq, 5pa, 5qa, 5se, 5uk, 5yb, 5yd, 5zal, 5aak, 5ac, 5agk, 5ahu, 5al, 5akm, 5alo, 5ap, 5ase, 5awt, 5bas, 5bbv, 5bev, 5bgv, 5bjd, 5bjx, 5hmb, 5hmw, 5bur, 5bvf, 5cah, 5cbj, 5cfe, 5cgw, 5chl, 5cno, 5cns, 5cpf, 5cqa, 5cqu, 5csa, 5css, 5csw, 5cto, 5cuc, 5dag, 5dah, 5dal, 5dan, 5dao, 5dh, 5dl, 5hw, 5jl, 5ul, 5nw, 5ql, 5sb, 5sk, 5tc, 5vc, 5vr, 5wt, 5yd, 7adg, 7aek, 7ajj, 7ij, 7kk, 7lu, 7nx, 7uj, 7uv, 9dkv, 9efy, 9wo. Australia: 2cs, 2lo, 2tm, 3ef, (5bg), 9dr. British: 2cc, 2od, 5lf, 5nn, 6tm, Canada: 1ar, 1ef, 4fv, 9ak. Cuba: 1af, 2mk. Denmark: 7ec. France: 3go. Mexico: 1aa, 1af, 1b, 1k, 1x. New Zealand: 1ao, 2aq, Porto Rico: 4rl, 4sa. Samoa: u6ZAC. Misc.: Ane, fl, fw, lpy, lpz, kfuh, nlsr, npp, nrri, nve, wap, wnp, wvz, pcuu, fsz, in. (All on 40 meter band).

By H. C. C. McCabe, 71 Holloway Road, Wellington, New Zealand

U. S. A.: 1axa, 1arh, 1aep, 1are, 1anq, 1aoa, 1amf, 1aao, 1azd, 1bql, 1bvl, 1bzp, 1bg, 1cep, 1cmx, 1er, 1ka, 1uw, 1to, 1pl, 2acs, 2agw, 2ahm, 2bee, 2bbx, 2cgl, 2cqz, 2cvj, 2cx1, 2gy, 2lu, 2zb, 3edk, 3afq, 3aha, 3auv, 3chg, 3ld, 3lw, 4sb, 4fg, 4rm, 4fl, 4tv, 4cu, 4oa, 5ade, 5acl, 5ald, 5all, 5akz, 5amw, 5ado, 5atv, 5aql, 5afd, 5alj, 5agu, 5akl, 5ame, 5aua, 5akn, 5ev, 5se, 5ls, 5ms, 5uk, 5oq, 5wl, 5tj, 5nq, 5va, 5lg, 5ox, 5jd, 5zal, 5b5, 5sb, 5clg, 5nx, 5ct, 5hm, 5avj, 5das, 5aaf, 5akz, 5ut, 5bvf, 5vr, 5dah, 5cto, 5dal, 5css, 5xad, 5cat, 5hu, 5cgw, 5alv, 5bvs, 5trj, 5bqu, 5asv, 5cah, 5cmq, 5zh, 5dab, 5vc, 5bv, 5csw, 5jp, 5ur, 5alj, 5dam, 5bgv, 5zd, 5ae, 5ake, 5bkv, 5bjd, 5akm, 5dh, 5ajl, 5adt, 5asr, 5abg, 5sk, 5clp, 5beb, 5bjv, 5rw, 5fh, 5ccy, 5alv, 5zac, 5css, 5akx, 5aon, 5daq, 5bmw, 5bas, 5bvy, 5bjd, 5cix, 5cnc, 5ckm, 5kb, 5ew, 5chl, 5bap, 5ckz, 5cls, 5abt, 5awt, 5sz, 5apj, 5bgb, 5bbv, 5aea, 5cct, 5ahp, 5ccp, 5agk, 5dan, 5bg, 5bcp, 5ut, 5ac, 5bdn, 5ds, 5wr, 5bip, 5zbn, 5bc, 5eb, 5aqp, 5cuk, 5che, 5afg, 5hc, 5bur, 5bcs, 5oa, 5fh, 5nw, 5bon, 5bav, 5cgu, 5aak, 5bhq, 5ml, 5dag, 7ay, 7it, 7de, 7au, 7uv, 7ly, 7uz, 7nx, 7av, 7uq, 7uj, 7abf, 7na, 7to, 7df, 7aek, 7adq, 7dj, 7gb, 7fb, 7wu, 7hl, 7vp, 7nl, 8tx, 8eq, 8ay, 8bpl, 8bce, 8aly, 8cyl, 8jq, 8pk, 8bnh, 8nt, 8ayy, 8sf, 8ced, 8gz, 8cau, 8bf, 8pl, 8buc, 8cbi, 8byn, 8se, 8ada, 8caz, 8gk, 9ek, 9uq, 9cex, 9ebo, 9dtk, 9bhq, 9dng, 9amd, 9xn, 9ado, 9czz, 9efy, 9aod, 9bpy, 9eky, 9aef, 9dvr, 9bvh, 9ff, 9dwn, 9akt, 9eld, 9adr, 9ale, 9dex, 9tj, 9mn, 9dpy, 9akf, 9ebx, 9dpx, 9ecc, 9aot, 9dfj, 9bht, 9bbh, 9cjm, 9dac, 9zt, 9bez, 9dkv, 9aul, 9dr, 9efs, 9ua, 9wo, 9bwo, 9aim, 9dwo, 9bpb, 9bwb, 9ded, 9cxx, 9cjs, 9egu, 9hp, 9dqr, 9yav, 9eel. Alaska: 7de, wwo. Canada: 3za, 4gt, 4bv, 4aa, 5hp, 5ef, 5ct, 5go, 5ba, 5gt. Mexico: 1aa, 1b, 1k, 1x, 2ei, 9a, xda. Hawaii: Fx1, 6buc, 6aff, 6ajl, 6tz, 6cst, 6def, 6asr. Porto Rico: 4sa, 4rl. Chile: 1eg, 2rm, 2re, 9tc. Argentine: Lpz, afl, cb8. Brazil: lab, 2sp. Philippine Islands: 1hr. Japan: 1aa. France: 8fq, 8tok. Holland: Osv, obq. England: 2nm, 2sz, 2cc, 2kf, 2lz, 2od, 5lf, 6tm, 6td. Italy: 1mt. Samoa: Vmg, 6zac. Miscellaneous: Ane, lcc, wap, wqo, wqn, wiz, npm, npr, nrri, nerkl, fsz. Exact log kept here. Will qsl card anyone desiring report.

By 1CV, 18 Prospect Hill Ave., Somerville, Mass.

The following worked using a "boot-leg" type 201-A with less than 300 V. RAC.
2aan, 2acs, 2adc, 2afg, 2aey, 2ahg, 2ahw, 2amw, 2anm, 2ang, 2ajj, 2ait, 2ahk, 2aqr, 2at, 2bm, 2bo, 2bwa, 2bvp, 2bq, 2bdj, 2cdm, 2cqz, 2cpd, 2chu, 2chm, 2cgb, 2cgl, 2erb, 2erp, 2cub, 2cvj, 2cxy, 2cyh, 2cyw, 2ez, 2go, 2ku, 2fq, 2fo, 2lm, 2va, 2sy, 2ain, 3afw, 3ais, 3auk, 3auv, 3bel, 3bel, 3btq, 3cjj, 3cjin, 3kj, 3ju, 3jd, 3oq, 3pf, 3qt, 3tp, 3tr, 3uj, 3uw, 3wn, 3agm, 3anj, 3bmt, 3buv, 2bpm, 3ds, 3in, 3xm, 4ux, 8ave, 8akk, 8aks, 8aci, 8fe, 8blx, 8ckm, 8cnx, 8cwp, 8cvh, 8dbm, 8dqa, 8drj, 8dhx, 8vo, 8rv, 9bfx, 9ehu, 9rw, 9xd, 9asa. Can.: 2ax, 2av, 2fo, 3afz, 3tf, 3ni. Hrd by English 2ta, 6td, bvj.

(Continued on Page 44)

FROM THE RADIO MANUFACTURERS

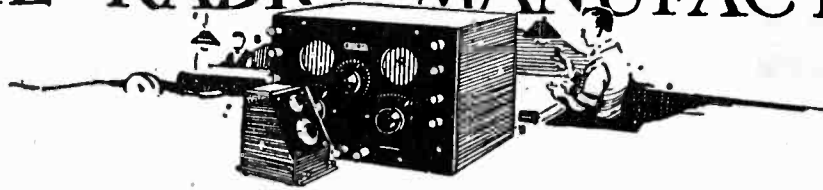

The Rathbun Straight Line Frequency Converter is a new dial containing an ingenious mechanism which imparts a straight line frequency characteristic



curve to the old type semi-circular plate condenser. It is designed so that it turns through one complete revolution while the plates of the condenser are turning 180 degrees.

The New Thorola Rheostat is designed with a contact arm and shaft whose tension is set at the factory and is undisturbed when attaching to the panel by means of its single hole mounting. This gives great smoothness and dependability in operation.

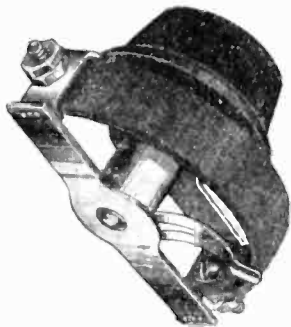

It is made in 6 and 15 ohm sizes. The resistance wire is made in a half circle, thus permitting rheostat placement at any angle in a variety of positions.

The Pacent Straight Line Frequency Condenser is of the metal end-plate, grounded rotor type, and is designed so that stations can be equi-spaced according to frequency.

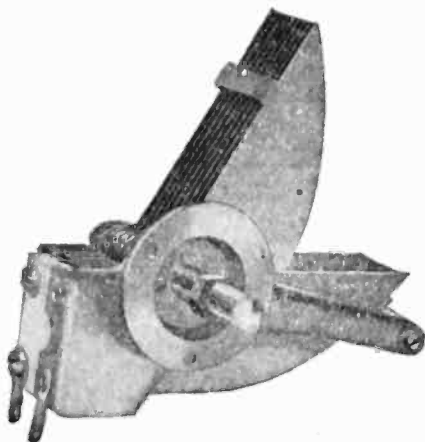

The one hole mounting and rigid construction will insure perfect operation after the condenser has been mounted in the set.

The Selector Improved Loud Speaker is designed to give perfect tonal reproduction regardless of the power input, so that it can be used with the new power



tubes without trouble from rattling of the diaphragm. It is finished in black crystalline enamel, and is arranged for table mounting.

The Eby UX Socket is designed to accommodate the new UX base now provided with storage and dry battery tubes, and will also serve with any of the new

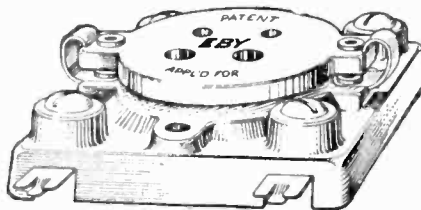

rectifier tubes. It has soldering lugs as well as terminal screws, and the socket springs have a positive grid which insures perfect connections.

The U. S. Tool Multiple Condenser for single control receivers has three sets of rotor and stator groups, the rotors being on a common shaft and connected to the metal end plates. The stator groups are insulated with hard rubber and each individual rotor group can be adjusted to any position by means of set screws.

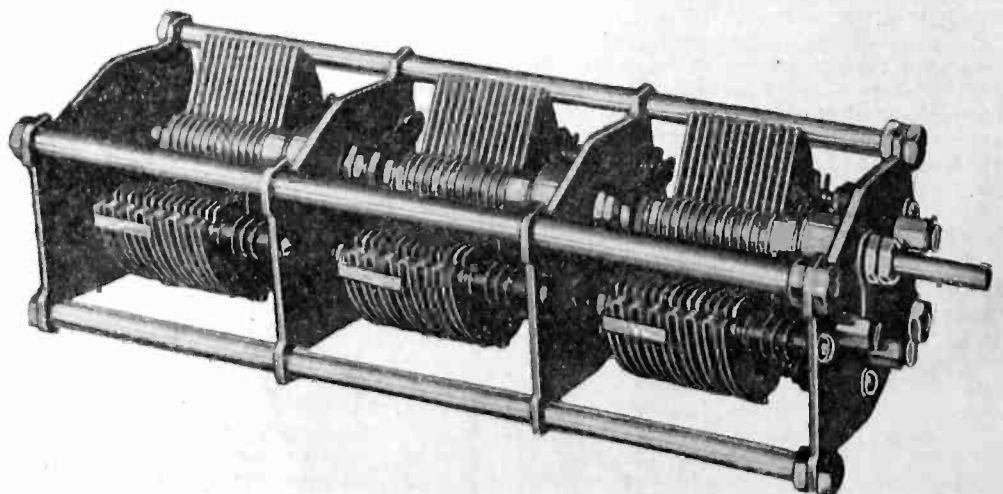

The Daven Leakandenser is a combined grid leak and grid condenser, arranged for mounting on a set of spring clips, so that the unit can be quickly



changed. The Leakandenser is made with five different values of grid leak resistance: 2, 3, 4, 5 and 7 megohms.

The Fynur Vernier Control can be attached to any variable condenser having the standard 1/4-in. shaft and imparts a



smooth, evenly operated vernier adjustment. The dial has no gears, and hence cannot develop backlash or lost motion.

The Sterling Universal Tube Tester is a simple device designed to test vacuum tubes for various defects which may



develop. It has two meters and is provided with an adaptor so that the tube to be tested is actually connected in the circuit in which it is to be used.

Supremacy

IN EVERY industry there is some one product that by sheer merit and outstanding quality and performance is accepted as the standard by which other products may be judged. In the Radio Industry it is the Mu-rad Transcontinental Receiver. In this great Radio Receiver, for the first time, unmatched tone-quality, absolute selectivity, extreme distance and simplicity of tuning have all been perfected.

Only One Dial to Tune

Aside from its pure, natural tone, the most remarkable feature of the new Mu-Rad is its One Dial Control.

MU-RAD RADIO CORPORATION

Factory:
Asbury Park, N. J.

Sales Offices:
Newark, N. J.

Write Dept. G-4
for Literature

The - ONE DIAL CONTROL -
MU-RAD
Transcontinental Receiver

Tell them that you saw it in RADIO

A Tungar keeps your radio batteries always peppy-

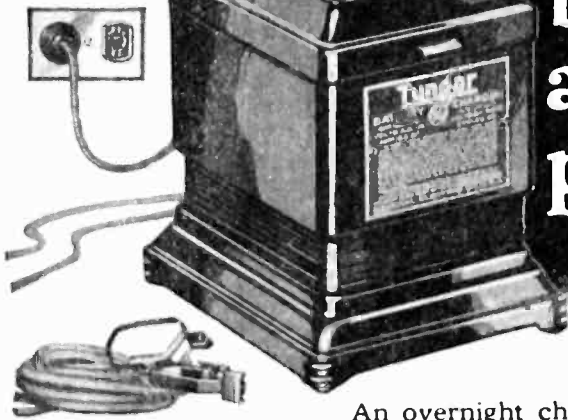

An overnight charge with a Tungar costs about a nickel. It peeps up both "A" and "B" batteries and keeps your radio set at its full-toned best.

Tungar — the original bulb charger — is noiseless. It contains no substance which could spoil furnishings. Just clip it to your set and plug it into the house current. It can't blow out Radiotrons if the battery is left hooked to the set while charging.

Use a Tungar—the charger that needs no attention.



The Tungar is a G-E product, developed in the Research Laboratories of General Electric.

The new Tungar charges any make and size of storage battery: radio "A" and auto batteries, and "B" batteries as high as 96 volts in series.

East of Rockies

Two ampere size \$18.00
Five ampere size \$28.00
60 cycles . . . 110 volts

Tungar

REG. U.S. PAT. OFF.

BATTERY CHARGER

Tungar—a registered trademark—is found only on the genuine. Look for it on the name plate.

Merchandise Division
General Electric Company, Bridgeport, Conn.

GENERAL ELECTRIC

ARE YOU A SUBSCRIBER?

SEND \$1.00 FOR A TRIAL SUBSCRIPTION TO "RADIO" FOR 6 MONTHS

The "Windham" Variable Condenser

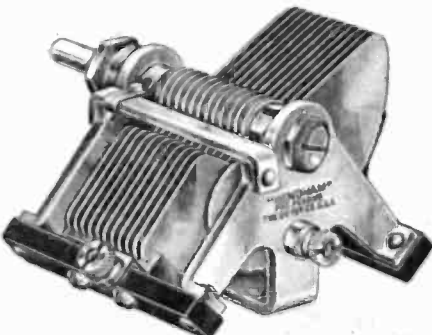

A durable, rigid instrument with correct electrical characteristics and made by skilled mechanics. It is provided with adjustable bronze cone bearings, the brake is independent of the bearings and adjustable. The plates are straight line.

It occupies small space, single hole mounting.
The price is right.
Desirable territory open.

The Goyer Company, Willimantic, Conn. U. S. A.

CALLS HEARD

(Continued from Page 41)

By **6DNL**, 528 So. Garnsey St., Santa Ana, Calif.

1aff, 1pl, 1sl, 1wc, 1yb, 2agq, 2bck, 2bpb, 2bu, 2ceb, 2cay, 2cns, 2cxy, 2cpa, 2fo, 2mm, 2wc, 3adv, 3bct, 3cgv, 3er, 4aad, 4fl, 4ha, 4lo, 4kn, 4oa, 4rm, 4sl, 4xc, 5aab, 5ado, 5agm, 5ail, 5amg, 5amk, 5atv, 5atp, 5atf, 5aua, 5ef, 5he, 5hy, 5jd, 5jf, 5oy, 5rg, 5uk, 5yd, 5zal, 7acl, 7gs, 7gy, 7uj, 7uv, 8alg, 8aly, 8boy, 8bvt, 8cau, 8cgr, 8dac, 8djk, 8don, 8eb, 8er, 8fl, 8gy, 8gq, 8jj, 8pl, 8se, 8ze, 8zu, 9adk, 9aim, 9akf, 9apm, 9ate, 9bcn, 9bez, 9bpy, 9bmx, 9bwb, 9bwx, 9ccv, 9cgu, 9bz, 9cea, 9dac, 9dbb, 9deq, 9afp, 9dkd, 9dmj, 9dng, 9dwb, 9ecc, 9ecp, 9ez, 9eez, 9eky, 9ejl, 9us, 9wo, 9xax, 9zt, c-3nf, c-3ni, c5go, hu-6buc, hu-6dbl, hu-fxi, mlaf, mlk, mln, m9a, nlsr, nkf, npg, npm, nqql. Comm.: fw, wir, wiz, wqi.

By **7MF**, Harold DeVoe, 1310 West Main Street, Medford, Oregon.

U. S. A.: 1acl, 1aff, 1ahg, 1anq, 1aoa, 1atj, 1bdx, 1bes, 1bke, 1blu, 1caw, 1ch, 1ck, 1ckp, 1hn, 1nt, 1or, 1qm, 1si, 1vc, 1yb, 2aim, 2aky, 2amj, 2bo, 2box, 2cl, 2cty, 2cqz, 2cv, 2cyx, 2fo, 2kg, 2kr, 2ku, 2kx, 2mm, 2wr, 2xaf, 2zv, 3bdz, 3bof, 3chg, 3jw, 4dc, 4fl, 4je, (Porto Rico), 4km, 4kn, 4pk, 4rm, 4sa, (Porto Rico), 4we, 5aid, 5ak, 5alj, 5amd, 5amk, 5arn, 5asj, 5atf, 5ce, 5fh, 5gj, 5jd, 5oq, 5pi, 5qz, 5se, 5zai, 6ano, 6oa, (Hawaii), 6zaf, 7kn, (Alaska), 8ada, 8adm, 8afq, 8aje, 8aun, 8baf, 8bga, 8bqm, 8bsc, 8buk, 8can, 8cbr, 8cjb, 8cjt, 8cni, 8cnx, 8coz, 8eg, 8eq, 8ex, 8gl, 8jq, 8mc, 8pk, 8ry, 8se, 8si, 9adk, 9ado, 9adw, 9aim, 9ajm, 9akf, 9aln, 9alr, 9amt, 9ark, 9atq, 9bbh, 9bcn, 9bdu, 9bbz, 9bkk, 9bkr, 9bmd, 9bml, 9bmn, 9bmx, 9bnd, 9bnk, 9bol, 9brg, 9bvh, 9bwb, 9bwo, 9ccn, 9ccv, 9cej, 9cfv, 9cll, 9cj, 9cl, 9cur, 9cun, 9cwn, 9cwo, 9cxx, 9dac, 9daj, 9deq, 9dfq, 9djj, 9dmj, 9dnt, 9dng, 9dpr, 9drd, 9dv, 9dwb, 9dwp, 9dyt, 9eak, 9ecc, 9eel, 9efs, 9egn, 9ehw, 9eiz, 9eje, 9efy, 9ek, 9eky, 9fj, 9gh, 9hp, 9mm, 9mn, 9se, 9xn, 9za. Foreign—Australian: 2bk, 2cm, 2yl, 3ef, 4bg, 5do. Canadian: 3ael, 3kp, 3nl, 4gt. French: 8zf. French Indo-China: ane. Hawaiian: fxl. Mexican: 1b, 1aa. Argentine: db2. New Zealand: 1ao, 1ax, 2ae, 4ag, 4ar, 4as. Naval: nlsr, nkf, npg, npm, npu, nra, nve. Misc.: lpw, wap, wir, wiz, wqo. 7MF is on 40 meters with a five or fifty watt. Will appreciate any reports on my signals and will QSL promptly.

By **6ALV**, 1026 Park St., Alameda, Calif.

Canadian: 2be, 2cg, 2dx, 3aa, 3ni, (4ah), (4al), 4ck, 5bm, 5bz, 5ef. Mexican: 1aa, 1b, 1g, 1k, 9a. Hawaiian: 6oa, 6dcf, (fx1). New Zealand: 1ao, 2ac, 4ag, 4as. Australian: 2ds, 2tm, 2yl, 3bu, 3xo, 3yx. Philippine: 1hr. Japanese: 1aa. Brazilian: lab. Naval: naj, npm, nrrl, nve, nlsr. Samoa: npu. Misc.: kfuh, wvy, vmg, wiz, wqo, gdvb.

By **6ASM**, C. Nichols, R2, Box 952N, Inglewood, Calif.

1acl, 1axa, 1bhs, 1bql, 1sl, 1yb, 1za, 2aks, 2aim, 2bir, 2brb, 2bkr, 2bxj, 2blm, 2cbj, 2clx, 2cxl, 2ce, 2cur, 2cpa, 2cty, 2cuj, 2gk, 2kr, 2mu, 2mm, 2nw, 2nf, 2wr, 2rr, 2xaf, 2zu, 3afq, 3bmc, 3bct, 3bg, 3bqg, 3cel, 3cm, 3hq, 3ig, 3qs, 3vx, 4aae, 4bq, 4cr, 4do, 4ej, 4er, 4fl, 4fn, 4io, 4jr, 4ks, 4kn, 4ku, 4lt, 4oa, 4rm, 4sl, 4vq, 4we, 5aab, 5aav, 5asv, 5agu, 5atx, 5atf, 5aid, 5ail, 5amk, 5adz, 5amw, 5ado, 5akz, 5ce, 5ew, 5gj, 5he, 5jf, 5ls, 5lg, 5nq, 5nw, 5ot, 5ox, 5oq, 5ov, 5ph, 5rg, 5uk, 5zal, hu-6jl, hu-6buc, hu-6dbl, hu-6dcf, hu-fx-1, 7aek, 7ki, 7hl, 7ip, 7ly, 7mz, 7uj, 7uz, 8adm, 8aly, 8bwb, 8bql, 8bkq, 8boy, 8bip, 8bdf, 8buk, 8cau, 8cud, 8cbr, 8dka, 8dfb, 8er, 8es, 8eg, 8eq, 8gs, 8jl, 8jq, 8pl, 8pk, 8rv, 8tx, 8su, 9ada, 9ado, 9aed, 9aio, 9akf, 9ayp, 9apm, 9bcn, 9bdw, 9bht, 9bmx, 9bub, 9bwb, 9bwo, 9bwx, 9cea, 9che, 9cpo, 9cun, 9cwo, 9dac, 9daj, 9dga, 9dms, 9dng, 9dnp, 9drd, 9dtm, 9ebr, 9ecc, 9ecp, 9eel, 9eez, 9efs, 9ix, 9ph, 9qr, 9ql, 9tj, 9wo, 9xn, 9zd, 9zt, 9zk, pr-4sa. Mexico: 1aa, 1ax, 1f, 1k, 9a. Canadian: 5ef, 5hp. N. Z.: 1ax, 4ag. Australia: 2cm. Commercial: wqo. All QSL's wud be appreciated.

By **Burton Dare** and **John Cunningham**, **CAVE, 68PG, CRE, 1058 Fleet Road, Oakland, Calif.**

1ary, 1ajx, 1apk, 1are, 1bdt, 1bdx, 1bhm, 1cme, 1cmp, 2agw, 2ana, 2axf, 2br, 2brb, 2kf, 2kc, 2rk, (2zb), 3abw, 3adq, 3adt, 3bjp, 3bss, 1cny, 3ot, 3yo, 4fg, 4fm, 4gw, 4io, 4my, 4uk, 4ll (vry consistent) (5ary), (5aef)? (5se) hrd too numerous. 6bhx (qra?), 8ave, 8aow, 8add, 8ago, 8apn, 8bal, 8bhx, 8bpo, 8cyl. Canada: (5hs), (5dd), (5hp), (5ef), 4bv. Foreign es Commercial: nuqg, (nqc), numn, 6zac, kel, wgy, (ax-2), kfuh, kfum, rhal, chieg-, z4ag, z4aa-, a2yl, 2xa. All qsl's ansurd. Qrk 15 watt kenotron rae"

(Continued on Page 76)

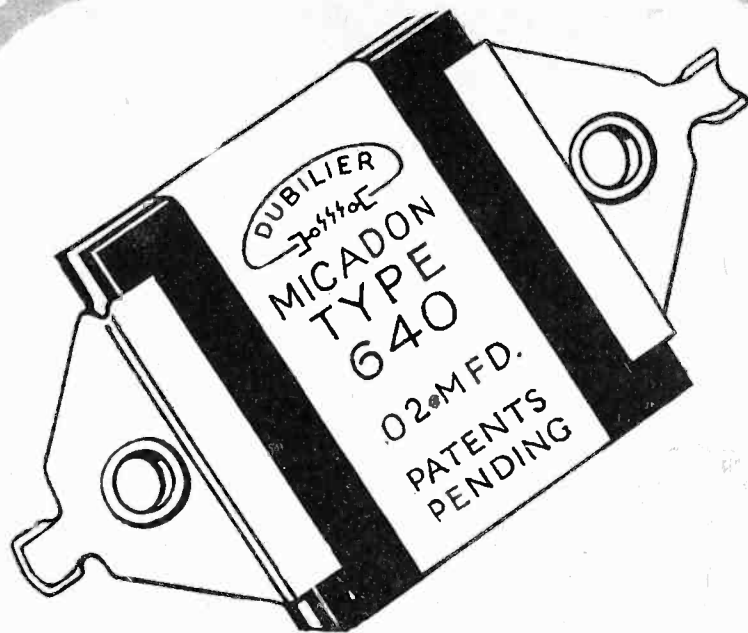

MICADONS

Found in famous radio sets

In radio sets that have earned fame and a reputation for quality, you will find Micadons—the foremost fixed condensers of radio.

Over 25 Million in use

More than 25 million Micadons are today giving satisfactory service—they are found in 90% of all the radio sets in use.

The reason is—

Dubilier *knows how* to make efficient fixed condensers and their methods are fully protected by basic patents. Micadons are the result of twenty years' intensive, scientific research.

Dubilier

CONDENSER AND RADIO CORPORATION

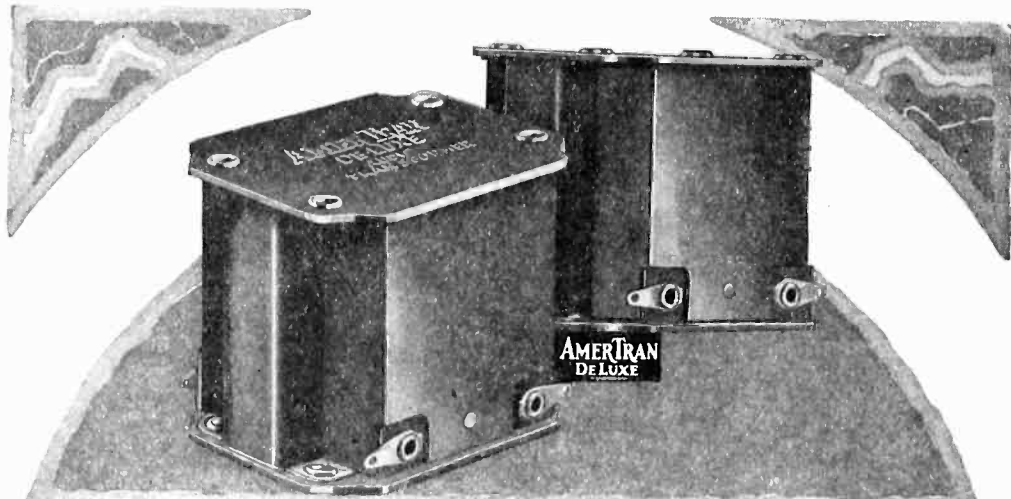

Volume—with True Quality!

The value of radio as an entertainer increases only with the realism and quality of reception. This requires good broadcasting—reception and amplification equal to, or better than, the broadcast range of audio frequencies—and a loudspeaker of uniform response over the same range. Heretofore one of the weak links in this chain has been the audio amplifier.

But it is now possible with AmerTran DeLuxe audio transformers to obtain faithful, strong reproduction over a range of frequencies down to the lowest pitched audible sound. This is nearly three octaves lower than that previously obtained. The deep boom of the drum, the thrum of the base viol, and the thunder of the pipe organ are reproduced with startling realism—and at no sacrifice of the highest notes within the audible range. Once tried, the AmerTran DeLuxe will be recognized as setting a new high standard of excellence in audio amplification.

AmerTran DeLuxe requires no special circuit other than the use of a large tube in the last stage to prevent overloading at the low frequencies brought out. It is made in two types.

Price, either type, \$10.00

We have prepared a booklet describing these and other AmerTran products, together with recommendations for their use. We shall be glad to send you a copy upon request.

AMERICAN TRANSFORMER COMPANY

178 Emmet Street, Newark, N. J.

"Transformer builders for over twenty-four years"

California Representative: W. I. OTIS, 303 Rialto Building, San Francisco



AmerTran Audio Transformers type AF6 (turn ratio 5) and AF7 (turn ratio 3½) have been substantially reduced in price. As before, they are today the leaders in their class. No changes have been made in the electrical characteristics since they were first sold. Either type now \$5.00.

Read by 43,750 Families

—This leading Pacific Coast weekly program and schedule magazine contains 64 pages of the most reliable data in print.

50 cents

for the next 12 issues—
mailed to your home.

**RADIOCAST
WEEKLY**

"The Recognized and Accepted Authority"
Pacific Bldg. - - San Francisco

THE REGENO-NEUT.

(Continued from Page 38)

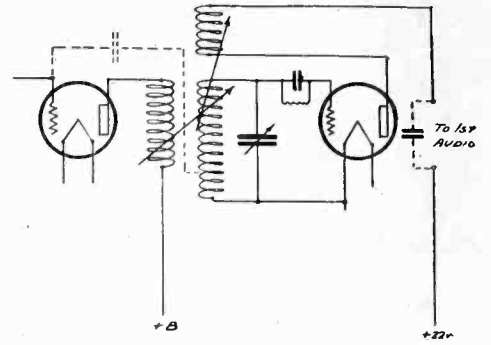

Fig. 1. Regeneration With Tickler Feedback.

(2) As many persons object to the tickler adjustment, the tickler can be wound as a continuation of the grid coil (with a tap between) and a condenser may be provided as a control, acting therefore as capacity feedback, shown in Fig. 2.

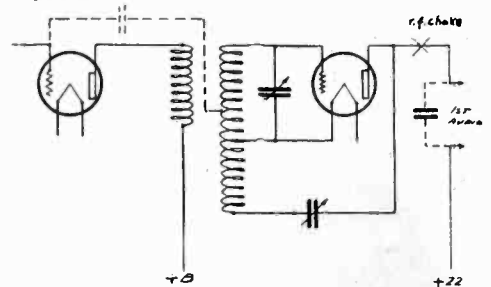

Fig. 2. Capacity Feedback Through Series Condenser and Inductance.

To those who wish to minimize the number of controls it may be pointed out that tandem condensers are now available on the market, and if one of these be substituted for the usual first two, then the addition of the regenerative control will not be felt a hardship.

Note that the second neutralizing condenser is best removed when utilizing either of the above arrangements. Radiation need not be feared because of the retention of the first neutralization.

FOUR-TUBE SET

(Continued from Page 16)

leak value does not cure the difficulty, the series resistance in the tickler lead is recommended. It is very important to note the correct position of the tickler coil on the r. f. transformer. If it is placed at the grid end of the secondary coil, there will be sufficient distributed capacity between windings to tune the secondary to a wavelength around 275 meters, and stations below that wave cannot possibly be received. If this effect is noticed when the set is completed, it is an almost certain indication that the tickler coil is at the wrong end of the secondary and the coil should be changed to its proper position.

In wiring the under part of the base-board, if the various wires have a tendency to curve and will not lie flat on the board, it is permissible to bunch them fairly close together and lace them with twine so that they will present a solid and neat appearing form.

FADA Radio

All the comforts of home



WITHOUT doubt radio holds them at home—they need no longer seek amusement in less desirable environments!

But nowadays it is not enough to have radio — one must have *superlatively good radio*, for the rising generation are particular as to pleasure.

“FADA RADIO—the Standard of Reception” is radio at its best.

Clear as a bell, tonally true and *human*, this superb instrument has abolished catch-as-catch-can programs—for with it you can tune in what you want with as much ease as you can tune out what you don't want!

Listen in yourself—the nearest Authorized FADA RADIO Dealer will gladly demonstrate FADA RADIO in his store or in your own home. Call him up *today* — there is no charge for this convincing demonstration.

Most Fada dealers will be glad to arrange convenient terms of payment. Send to 1581 Jerome Ave., New York, for free book B “FADA RADIO—the Standard of Reception”.

F. A. D. ANDREA, INC.

CHICAGO NEW YORK SAN FRANCISCO
FADA RADIO, LTD.—TORONTO FADA RADIO, LTD.—LONDON

*Manufacturers of TUNED RADIO FREQUENCY receivers,
using the highly efficient NEUTRODYNE principle.*

There is a FADA RADIO model for every purse—all 5 tube Neutrodyne sets for dry cell or storage battery tubes, from \$85 to Art Cabinet models up to \$300. Illustrated is the Queen Anne Desk at \$300.



Tell them that you saw it in RADIO

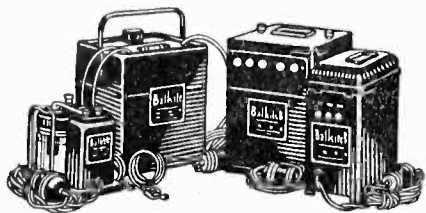

Equip your set with

FANSTEEL
Balkite
Radio Power Units

Balkite Battery Charger
Balkite Trickle Charger
Balkite "B"
Balkite "B" II

*the ideal radio
power supply*

The Balkite Battery Charger for charging "A" batteries. The Balkite Trickle Charger for continuous charging. Balkite "B" replaces "B" batteries—designed for sets of 6 tubes or less. Balkite "B" II—for sets of 6 tubes or more.

FANSTEEL PRODUCTS CO., Inc.
North Chicago, Illinois

PACIFIC COAST DISTRIBUTORS:
Seattle, A. S. Lindstrom Co., 95 Connecticut St. San Francisco, A. S. Lindstrom Co., 274 Brannan St. Los Angeles, A. S. Lindstrom Co., 324 N. San Pedro St. Portland, A. S. Lindstrom Co., 146½ N. 10th St. Salt Lake City, A. S. Lindstrom Co., 407 Dooly Bldg. Denver, Jack L. Hirsch Co., 1641 Stout St.

FANSTEEL
Balkite Radio Power Units

BALKITE BATTERY CHARGER · BALKITE "B"
BALKITE TRICKLE CHARGER · BALKITE "B" II
All Balkite Radio Power Units are Tested and Listed as Standard by the Underwriters' Laboratories

5 TUBE GUARANTEED RADIO **BIG POWERFUL MIRACO ultra 5**

Get Special Offer

Users everywhere report it gets programs coast to coast, Canada to Gulf, loud and clear on speaker; outperforms \$100 to \$250 sets. Many \$59.50 hear Europe. Mar. 59.50 velous value. Let users testimony convince you. Retail

FACTORY PRICES—SAVE **MIRACO RADIO GETS 'EM COAST TO COAST**

1/3 TO 1/2. Smaller Sets \$13.75 up, retail. FREE Literature on latest 1 to 5 tube models. Agents new low prices and SPECIAL OFFER! Write! MIDWEST RADIO CORPORATION Pioneer Builders of Sets 414-B-E 8th St., Cincinnati, Ohio

USE OUR TESTING LABORATORY. SEE PAGE 64.

The Wilson "B"
Radiopower Unit

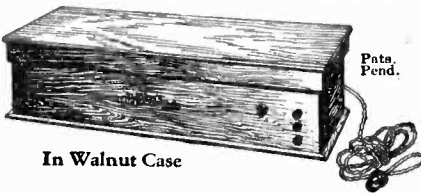

In Walnut Case

This new unit will enable you to get the most out of your receiver. Provides uniform "B" voltage at minimum cost. Operates from light socket. Will not set up the slightest hum. Hook it to your set and forget it except to switch it on and off. Nothing to adjust. Nothing to get out of order. No acid to spill. No expensive replacements. The most dependable, convenient and economical plate current supply. Price complete \$35.

Write for complete information

The Andrews
Paddlewheel Coil

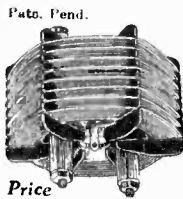

Price \$3.00

This coil can be used in any hookup requiring a high grade inductance. You will be pleased with results because of its negligible losses, minimum distributed capacity and exceptionally high ratio of inductance to resistance.

It greatly improves tone quality, making possible any desired volume without distortion. Used in such well-known receivers as the *Deresnadyne* and *Buckingham*. Ask your dealer for constructional blueprints of tested circuits employing this superior coil.

Our Technical Dept. will answer inquiries.

Duo-Spiral
Folding Loop

Handsomely finished in silver and mahogany to harmonize with the finest home furnishings.

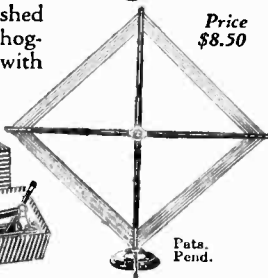

Price \$8.50

Folds neatly and compactly. Has graduated silvered dial and insulated handle. Use a *Duo-Spiral* for selectivity and to reduce static. A special model for every circuit.

If your dealer cannot supply these standard products, write direct.

Radio Units Inc.

1303 First Avenue Maywood, Illinois
Perkins Elect. Ltd., Montreal, Toronto, Winnipeg

RADIOCAST WEEKLY

Sixty-four Pages of Programs, Photos, Humor, Musical Reviews, Schedules, Tables, Editorials, Etc.

5¢ Per Radiocast Weekly
Copy 433 Pacific Bldg.,
SAN FRANCISCO

ALL-WAVE REGENERATOR

(Continued from Page 18)

are large enough so that noticeable discrimination in favor of the higher frequencies will be absent, but not so large as to provide a combination with an unfavorable discharge period.

A jack is provided for using three tubes, and another for using all four tubes where extreme volume is required. A C battery of 3 volts is shown connected to the grids of the first two audio tubes. This will be the approximate C voltage where 150 volts B battery is used for the last audio stage, but if only 90 volts B is used, then the C voltage for the first two stages should be reduced to 1½ volts by taking out a separate tap on the C battery. The schematic wiring diagram shows a UX-112 tube in the last stage, with 9 volt C battery and if dry cell tubes were to be used, a UX-120 tube, with 18 volts C battery and 150 volts B battery would be preferable in the power stage. The 18 volt battery in this case, is connected in series with the 4½ volt C battery already in the set, giving a total of 22½ volts negative grid potential for the last tube.

It will be noticed that according to the diagram the phones are cut into the output of the second stage in series with the coupling resistance, thus not disturbing the operating characteristics of this particular tube. Were this resistance to be cut out in favor of the phones as is customary in jack switching, then a C battery should be cut in to take care of the change in effective operating plate voltage due to the difference in phone and coupling resistances.

The actual assembly of the receiver is quite simple, and is well illustrated in the rear view of the set. The coil, with its rotor clearly visible, is at the right of the baseboard, while directly in front of it is a .5 mf. bypass condenser across the 4½ volt C battery to prevent reaction, as it is used in both detector and amplifier circuits. The small mica condenser visible in an upright position between the middle coupling resistance mounting and tube socket is a .002 bypass from plate to filament of the first audio amplifier. This condenser, normally connected from plate to filament of the detector, cannot be so connected in this circuit for in this position it would prevent regeneration. It frequently happens that the capacity of the set wiring, or of the primary of an audio transformer, is sufficient to accomplish this in a circuit of this type. Should this be the case, a choke coil as depicted in the diagram will be necessary, connected as shown and located some few inches away from the tuning coil system. Such a choke will seldom be necessary, and may be eliminated by short-circuiting the wires leading to it.

The tube sockets should be suited to any of the new UX tubes and due to

(Continued on Page 50)

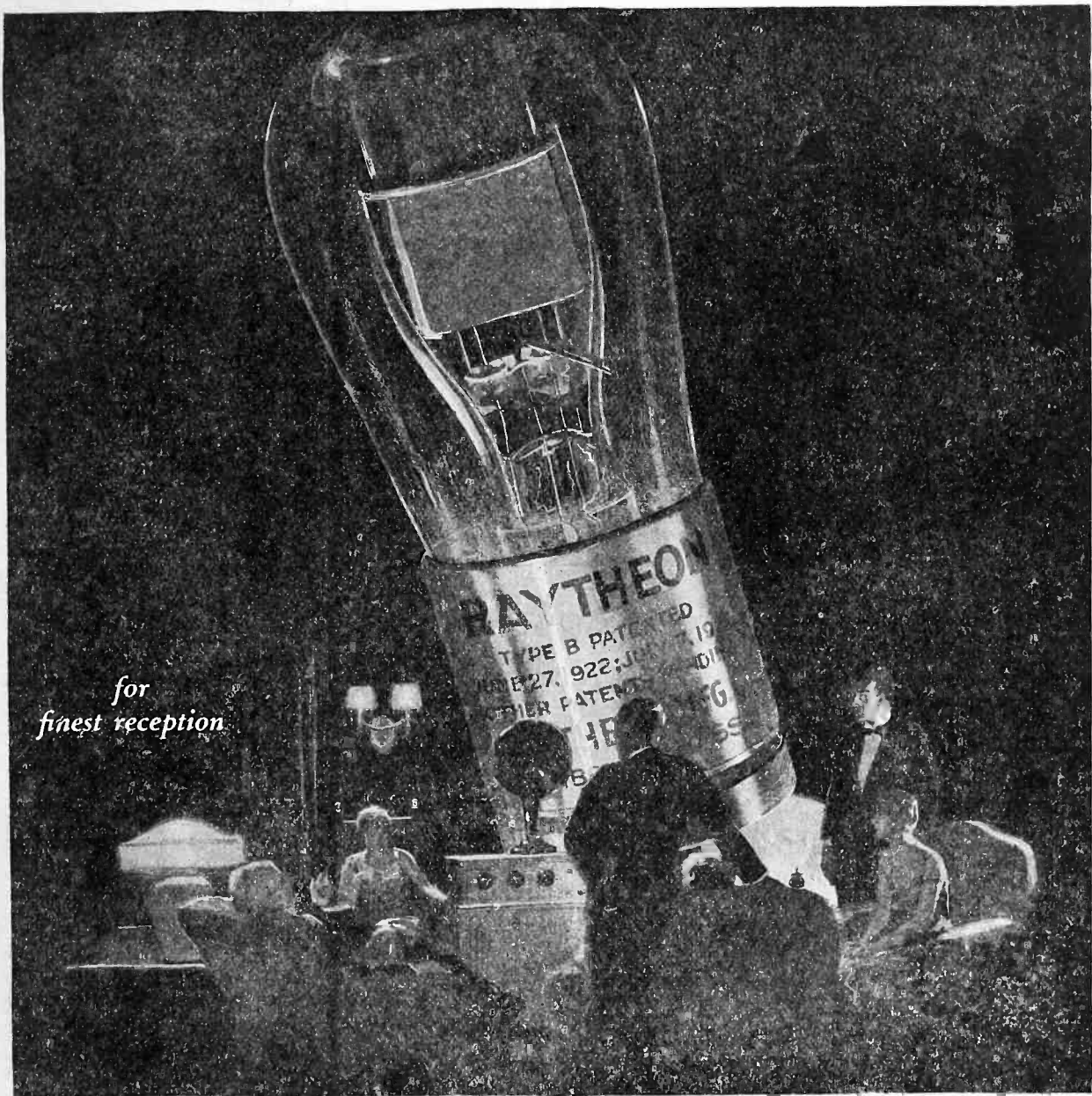

for
finest reception.

RAYTHEON

the result of five years of research and experiment, and the work goes on to maintain the standard already set. Ask your dealer to explain the meaning of Full Wave Rectification, No Filament, Reserve Power, and a sixty milliamperere rectifier for six dollars.

Progress comes not through a happy hit or miss process. In each link of the broadcast chain—from microphone to loud speaker—we realize the results of years of unremitting effort for something better. Today attention is focused on the elimination of the battery, that most unreliable and expensive source of electric power now in commercial use. That this should come about as a result of scientific research was to be expected. That it should make possible an added beauty of tonal reproduction gives further assurance of the permanency of the RAYTHEON rectifier in this field.

RAYTHEON B-eliminators or specially designed parts for home-built units are made and sold by these and other well-known manufacturers:

Acme Apparatus Co.	Mayolian Radio Corp.
All-American Radio Corp.	Modern Electric Mfg. Co.
Dongan Electric Mfg. Co.	Thordarson Electric Mfg. Co.
General Radio Co.	Toke Deutschmann Co.
Jefferson Electric Mfg. Co.	Webster Co.



RAYTHEON MANUFACTURING COMPANY
CAMBRIDGE, MASSACHUSETTS



(Continued from Page 48)



A Certified Check Against Distortion

AS clear and mellow as chime sounds—let the "Electrad" Audiohm banish that stuttering, sputtering reception forever.

If you want pure tones, clear and mellow, whether high, low or medium pitch, improve your set with the Audiohm. Insure reproduction that will equal in smoothness and richness the original tones of the artist.

Every receiving set with one or more audio-transformers needs one of these tone, quality and volume controlling devices.

Always insist upon getting the genuine "Electrad" Radio Essentials. Look for the attractive blue and gold cartons on your dealer's counter. Variohms, Lead-Ins, Resistance Coupled Amplifier Kit, Lamp Socket Antenna, Certified Grid Leaks, Lightning Arresters, Fixed Mica Condensers, and many others.

Buy "Electrad" Radio Products from your dealer. If he can't supply you, write us, sending his name.

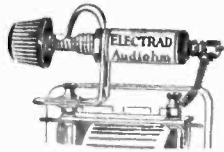

"ELECTRAD" AUDIOHM
Placed across secondary of your first audio-transformer. Eliminates distortion. Easy to attach. Simple to tune. Price \$1.50.

"ELECTRAD" LEAD-IN—Fit under closed doors or windows. No holes to bore. Easily installed. Efficient in operation. 3000 volt insulation. Extra waterproofing. Price 40c. Made to meet "Electrad's" high standard—there is a difference.

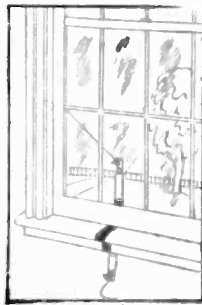

"ELECTRAD" LIGHTNING ARRESTER—Indoor type. A reliable safeguard always against ruined sets. Listed under re-examination service of the National Board of Underwriters. Should fire occur from lightning it is best to have an approved arrester. Price 50c.

ELECTRAD

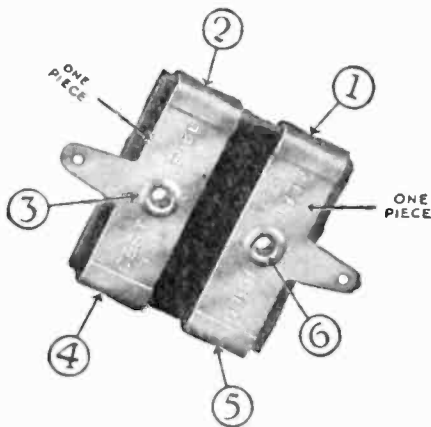

"The Six Point Pressure Condenser"

THE "Electrad" Certified Fixed Mica Condenser is a revelation in accuracy and design. Ingenious, rigid binding and firm riveting fastens parts securely at six different points, insuring positive electrical contact. Value guaranteed to remain within 10% of calibration. Standard capacities, 3 types. Licensed under Pat. No. 1, 181,623, May 2, 1916 and applications pending. In sealed dust and moisture proof packages. List 30c to 75c.

ELECTRAD Inc.

428 Broadway
New York City

the design of practically all UX sockets, the tube when being inserted should not be pushed directly down, but instead worked slowly around until it slips down naturally, as otherwise the socket springs might be damaged and the tube burned out.

To build the receiver, the list of parts shows what material will be required. It is needless to suggest that substitution be not indulged in by the prospective builder unless he is thoroughly familiar with the electrical requirements of each item, particularly as all parts listed are of standard reputable manufacture.

The panel should be laid out following the drilling template, shown in Fig. 2, all holes drilled, and where necessary countersunk. It may then be grained if desired by rubbing in one direction only with sandpaper and oil until all gloss has been removed. It may be engraved if desired, or an indicating mark for the tuning dial may be scratched with a scribe and filled with Chinese white.

No baseboard layout is given, as there is plenty of room, and the exact location of part is not important. In fastening down the parts, the lugs supplied should be locked so that they point in the directions evident from an examination of the rear view picture.

In wiring the set, it is necessary to remember that all possible wiring be installed on the base-board and panel separately, then the two screwed together, and the few remaining connections made. No binding posts are shown, as the antenna and ground connect to posts 1 and 2 of the coil socket, and the battery leads come in through the color cable, the ends of which terminate directly in the set wiring.

For operation, four tubes will be required, three 45 and one 22 volt B battery, at least one 4½ volt C battery, and a 6 volt storage battery for the 201A type tubes, or six dry cells connected in series parallel for the 199 type tubes. Dry cell tubes will give practically as good results as storage battery types, and therefore may be recommended since they eliminate the necessity of the wet battery. An antenna from 60 to 100 feet long, preferably outdoors, will be entirely satisfactory.

In testing the receiver, only the A battery should at first be connected, a tube inserted, the switch turned on, and the rheostat barely turned on. If it lights in each socket, the wiring is probably O. K. It should be further checked by removing the A plus lead and substituting for it the B plus leads one after the other, with which connections the tube should not light if the set is wired correctly and everything O. K. If so, then the B and C batteries may be connected, the tubes inserted and the antenna and ground connected. For 199

(Continued on Page 52)

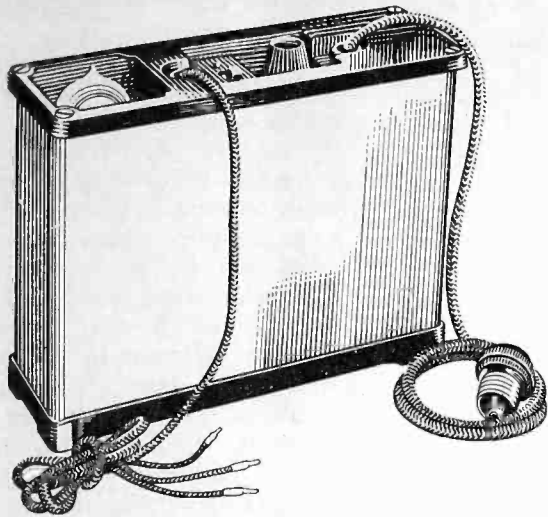

Illustration at left shows Acme "B"-Eliminator. Made in two types.

Type E-1 (110 volts 60 cycle).....\$50
 Type E-2 (110 volts D. C.)\$20

E-1 USES RAYTHEON TUBE

Parts for "B"-Eliminator

B-2 30 Henry Choke.....\$5.00
 B-4 Transformer\$7.00

An Acme "B"-Eliminator complete, or assemble one yourself from Acme parts

***No noise — no hum
 — no "B" Batteries !***

WHETHER you buy an Acme "B"-Eliminator complete or assemble one yourself from Acme parts, you will have no hum, no noise and no distortion. When you use Acme parts you will be using the same parts as used in the complete Acme "B"-Eliminator, and that has been proven to have no hum, no noise and no distortion.

The big job in finding a method of hooking up house electric current to replace "B" batteries in radio sets has not been to eliminate the hum. That was easy. The problem was to discover a way of overcoming the distortion.

Now, after two years' experiment and research we have won out.

You can guess the result. NO "B" batteries to quit cold when you need them most. You get permanent reception, better reception and higher voltage that is constant. There is nothing to wear out. The first cost is the last—and the current consumed is trifling. A cent for every six hours.

Not only this, but the new Acme "B"-Eliminator has two voltages—100 and 150. It is highly effective on any set from 2 to 10 tubes. What is more, the detector voltage is 0 to 70.

The rectifier consists of an Acme Transformer and vacuum tube, with no filament to burn out. This rectifier (Raytheon) tube handles both sides of the wave and will last indefinitely.

The filter so successfully smooths out the rectified pulses in current and voltage that a source of power is delivered of a better nature than batteries.

The full story of not only this new "B"-Eliminator but the new MA-2 closed transformer, the new Acme "double free-edge cone" loud speaker and all other Acme receiving apparatus is contained in the eleventh edition of "Amplification Without Distortion," which is just coming off the presses.

Most of you, as old friends of Acme, are probably familiar with former editions, over 200,000 of which have been issued. The new one is more complete and interesting than ever. Send for your copy.

If planning to assemble a "B"-Eliminator yourself send twenty-five cents for full sized diagrams and instructions showing how to assemble the Acme "B"-Eliminator.

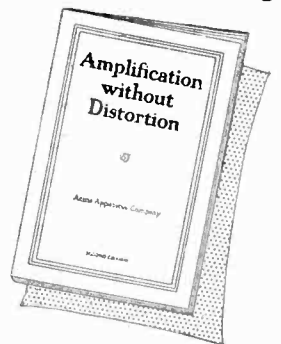

CLAUDE F. CAIRNS

President, Acme Apparatus Company

ACME APPARATUS CO.,
 Dept. D12, Cambridge, Mass.

Enclosed find 10 cents stamps or coin for my copy of the new 11th edition of "Amplification Without Distortion."

Enclosed find twenty-five cents stamp or coin for full sized diagrams and instructions showing how to assemble "B"-Eliminator. (A copy of "Amplification Without Distortion" included.)

Name.....

Street.....

City..... State.....

(Check proper square or squares)

ACME

~for amplification

Tell them that you saw it in RADIO

PRECISE
No. 480
Supersize Audio
Transformer
\$7.50

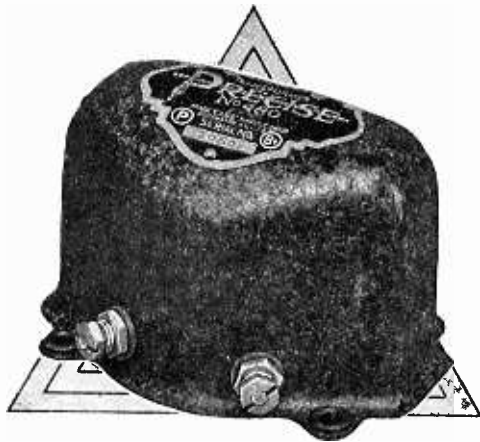

Do You Know

That Precise Syncrodensers are the ORIGINAL and ONLY straight-line frequency condensers combining straight-line capacity at the higher end, thus assuring uniform station separation?

DO YOU KNOW that Precise Syncrodensers will make your receiver more selective, due to the characteristics of design and construction?

Select Precise when building your receiver and be assured of maximum tuning efficiency regardless of what type of set you are constructing. They are rigid and compact and can be mounted either on panel or sub-panel, requiring a minimum of space.

Ask your dealer to show you the Precise line, or write for literature.



Rochester, New York

126 Liberty St., New York City
205 W. Harrison St., Chicago

Branch Offices:
821 Market St., San Francisco
454 Builders' Exchange, Minneapolis, Minn.

1127 Pine St., St. Louis, Mo.
701 A. O. U. W. Bldg., Little Rock, Ark.

Canadian Distributors: PERKINS ELECTRIC, Ltd.,
Toronto—Montreal—Winnipeg

Every Precise Instrument is a Laboratory Product

RADIO AGENTS WANTED 5 Tube Demonstrator FREE!

Earn \$25 to \$100 a week, part or full time. Everyone a prospect. Complete line standard sets and accessories, \$65 to \$99. Write today for illustrated catalog and exclusive selling plan for live dealers and community agents. 20TH CENTURY RADIO CO., 1011 Coca Cola Bldg., Kansas City, Mo.

ARE YOU A SUBSCRIBER?
SEND FOR TRIAL SUBSCRIPTION
\$1.00 FOR SIX MONTHS

LONG DISTANCE
Exclusive choice of MacMillan
for his North Polar Expedition.
ZENITH RADIO CORPORATION
310 South Michigan Avenue, Chicago, Illinois

You Can Get
Greater Reflex or Crystal
Set Reception if you use
the
BROWNLIE
Vernier Detector

\$2.00 at Your Dealer or Direct
ROLAND BROWNLIE & CO.
22 Saunders St. Medford, Mass.



A Laboratory
Product



**CRESCENT
LAVIE
RESISTANCES**

for Distortionless Amplification

Used in 50 big broadcasting stations. 12,000, 48,000, 50,000, and 100,000 ohms. For distortionless amplification. Order a Crescent today at \$1.50. Special sizes made to order. Discounts to dealers.

CRESCENT RADIO SUPPLY COMPANY
3 Liberty Street, Jamaica, N. Y.

(Continued from Page 50)

tubes, the rheostat should be barely on—for 201A tubes practically all the way on.

For all waves from 50 to 550 meters the inductance coils may either be purchased or wound on forms available on the market. For other waves they must be wound by hand as none are available ready wound. The winding specifications are given below, it being borne in mind that 1-2 is the rotor, 3-4 one of the stator coils, and 5-6 the other. If ends 4 and 5 were connected where they are adjacent in the middle of the stator form, then a continuous winding would be formed with ends 3 and 6 and center tap 4-5. B and C coils are space wound, each turn being separated from the next by winding on two wires simultaneously, one of which is later removed. The rotor need not be space wound. No. 26 d. s. c. wire is used, held in place by collodion, or amyl-acetate in which celluloid has been dissolved. The E size coil is layer wound, the stator having three layers.

Type	Range in meters	Coil 1-2	Coil 3-4	Coil 5-6
		1½-in. tube	2½-in. tube	2½-in. tube
110A	100-550	30T	45T	45T
110B	90-210	16T	17T	17T
110C	50-110	6T	8T	8T
110E	500-1800	60T	125T	125T

With one coil inserted in its socket, the regeneration condenser should be turned in until the set nearly oscillates, and the tuning condenser slowly rotated. If a station is heard as a whistle, the set is oscillating and the regeneration condenser should be cut out until only the voice of music is heard, as an oscillating condition in the set should not be tolerated. Once heard, a station may always be tuned in at approximately the same dial setting providing the position of the small rotor coil has not been materially altered.

It is fairly easy to locate a station not previously heard providing only its operating frequency is known, by the following method. To operate by this method, it is necessary to know the frequency range covered by given coil system. Let us take the coil which gives a range of roughly 1580 to 545 kilocycles. 545, the minimum frequency, subtracted from 1580, the maximum frequency, gives 1035, the number of kilocycles covered by a 100 degree rotation of the tuning dial. Obviously, one division on the dial is equal to 10.35 k. c. or, roughly, one transmission channel per dial degree.

Suppose, now that we wished to locate station WHT, operating on 400 meters or 750 k. c. 545 or the minimum frequency, subtracted from 750, the station frequency, leaves 205 k. c., which divided by 10.35, the number of kilocycles per dial division gives between 19 and 20 as a result. This means that station WHT will be heard at between 19 and 20 on the dial.

SM

SILVER

SIX

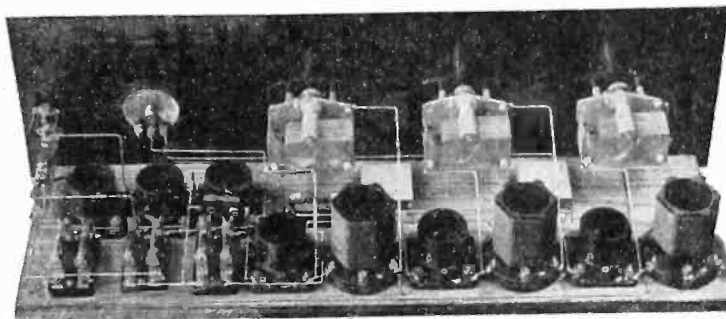

FACTS THE "WHY OF THE SIX"

As Described in Radio Broadcast for January.

SELECTIVITY is such that out of town stations may be brought to Chicago through twelve powerful local stations. Selectivity can be regulated at will, from a degree satisfactory for ordinary reception, up to the surprising limit where side-bands are cut. **SENSITIVITY** is so great that nothing will surpass the "Six" except special laboratory-built superheterodynes. Either coast may be brought in to Chicago during the summer months on a small antenna—in many cases on a loop.

FLEXIBILITY permits the use of antenna or loop with either detector, one or both stages of radio frequency amplification. Interchangeable R. F. Transformers, with adjustable antenna coupler, permit operation on all waves from 50 to 550—or higher if desired.

VOLUME is so great as to paralyze any but the best loud-speakers. Yet it may be adjusted to any degree by a single knob.

QUALITY cannot be excelled due to resistance coupled amplification. It is the only receiver that will bring real appreciation of "cone" speakers.

CIRCUIT consists of two stages of R. F. amplification with special oscillation control uniformly effective at all wavelengths, grid-biased detector and three stage resistance coupled audio amplifier.

EASE OF CONTROL allows use of one, two or three dials at will.

TUBES may be either dry cell or storage battery, with UV201-A's recommended. "B" Battery Consumption at 135 volts is below 10 milliamperes—less than one-third that of other six-tube receivers.

ASSEMBLY requires but a few hours, using only parts supplied in kit.

The "SIX" has taken the Radio Fans by storm. Thousands have built the "SIX" and thousands are building it today. Their letters say it is the marvel of Radio—and it is truly a great receiver. It has everything that makes for perfect reception, and still it is so simple that any novice can build it and get the same amazing results as an expert.

Write for Mr. Silver's description of his new "SIX"

TYPE 600 KIT, including all parts necessary to build the Complete "SIX" \$53.00

TYPE 610 KIT, essentials only, including 3 condensers, 3 inductances and 3 inductance sockets \$27.75

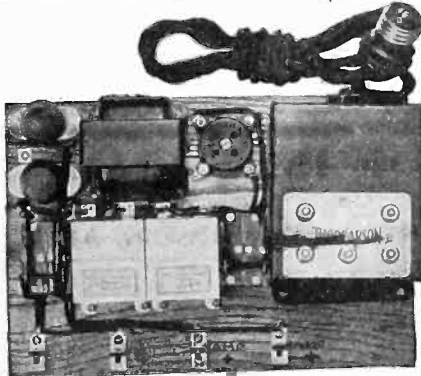

Wins First Prize

A SILVER "SIX" built by C. Wood Tatham won first prize in the "HOME BUILT SET CONTEST" at the Chicago Radio Show, Nov. 17-22.

Second Prize

In the same event was awarded to Mr. Hartley with a superheterodyne designed by McMurdo Silver.

And Second Prize

In the "MISS RADIO CONTEST" was won by another of Mr. Silver's designs owned and operated by Miss Dorothy Goedecke.

Silver Circuits are always in advance, always up-to-date—Prize winners over years.

The Improved Raytheon-Thordarson "B"-Eliminator

This Eliminator will deliver from 20 to 200 volts at three different, adjustable voltages with maximum current of 50 milliamperes—more than enough for the largest receiver.

The SM Type 650 Kit includes Thordarson Transformer, choke, Tube Condensers, genuine Raytheon Tube, Bradleyohms and all necessary parts.....\$34.

Assembly Instructions by McMurdo Silver.....10c.

Mail This Coupon

Silver-Marshall, Inc., Chicago, Ill.—106

Gentlemen: Please send me:

A—Complete building data on the Silver "Six," for which I am enclosing 50c.

B—Descriptive circulars on S-M Products.

C—Assembly instructions for S-M-Thordarson-Raytheon "B" Eliminator, 10c.

Name.....

See These and Other SM Products at Your Dealer's

Silver-Marshall, Inc.

106 South Wabash Avenue, Chicago



RADIO MAGAZINES Are First

1. **First** to carry the advertising of successful Radio Manufacturers.
2. **First** to come to the aid of a young industry and publish its ideas.
3. **First** to make Radio available to the home owner.
4. **First** in Radio advertising lineage.
5. **First** in purely Radio Circulation reaching 100% Radio interest, free from all fiction, general news and unrelated matter.
6. **First** for advertising productivity and economical coverage.
7. **The first** market for all Radio Manufacturers.

RADIO MAGAZINE PUBLISHERS' ASSOCIATION, Inc.

98 Park Place

New York, N. Y.

G. M. BEST'S ABC ELIMINATOR

As Described in December RADIO

Complete kit of parts \$49.50 - Assembled and wired \$54.50

(Less Milliameter and Tube. Milliameter \$7.50
Extra, UX-213 Tube \$7.00 Extra)

We Furnish Exact Units Used by G. M. Best. All Parts Sold Separately at Standard Prices.

¼ Cash Required With all C. O. D. Orders.

RADIO OWNERS SERVICE CO.

660 Twelfth Street, Oakland, California

We Cut, Drill and Engrave Radio Panels. Write for Price Sheet.

IMPORTANT! Best results with ABC Eliminator requires accurately matched tubes in your receiver. We furnish precision-matched Cunningham or Radiotron tubes in sets of 3, 4, 5, 6, 7, 8 and 9 at \$2.50 per tube, postpaid.

AUGUST & SEPTEMBER

BACK COPIES OF "RADIO"
With Best's Super-Het. Articles
Both for 50c.
"RADIO," SAN FRANCISCO

POTATO PEELINGS

(Continued from Page 23)

the catch on a double snap lock, taking good care that Bob should not see his actions as he passed through the door.

"Right in this way, kid, here's where the big business will come off," said "Bull," still with his suave manner. Holding open a door, he let Bob pass through ahead of him. "Wait a minute, I'll be right back," this time in a rather strained voice.

"But where's the radio set?" queried Bob, apprehensively.

"What radio set?"

"Wha—why you said that you had a big set here! Why there aren't even any windows in this room—let me out, I want to go home!"

"You'll go home all right kiddo, but not for a little while—maybe a few days. I got to write a letter to your old man and tell him what a nice little boy you are, and how much money you're worth." "Bull" had at last dropped his mask and was again the open crook.

Slamming the door on Bob's entreaties, "Bull" retreated to an upper room whence he returned in a short time with a cot and several blankets. Unlocking the door, he threw his burden on the floor at Bob's feet, and quickly closed and relocked the door.

By the time three-quarters of an hour had elapsed, "Bull" had made all of the windows and doors in the house secure, cutting off every avenue of escape for the boy. He then put out some cold meat and a piece of bread for Bob's supper. Letting the boy out and waiting until he had eaten the food, he returned him to the room without windows, locking and bolting the door, after which he left the house.

Seemingly only a few minutes after he had gone to sleep, Bob was awakened by a violent shaking of his bed. "Aw ma—this is vacation, let me sleep," he pleaded, sleepily.

"Get up you young rascal, before I dump you on the floor. You're gonna be the cook here while I take a rest. C'mon, hurry up, I'm hungry," The voice was that of "Bull" Dolt.

By now, the lad was wide awake, and scrambling out of the blankets, he made a dash for the door, only to be checked by the strong locks. So realizing the futility of exerting his young strength against that of the "Bull," he dressed, beginning his first day in captivity with work.

"Where'd yuh learn to cook, kid? That wasn't a half bad breakfast," said "Bull" evidently in a good humor after finishing the meal Bob had prepared.

"Oh, I'm a Boy Scout, and we all learn that," said Bob, proudly, notwithstanding the seriousness of his position.

"Well boy, you're going to do plenty of it so it's lucky for you that you know

(Continued on Page 56)

Fine Radio



Apparatus

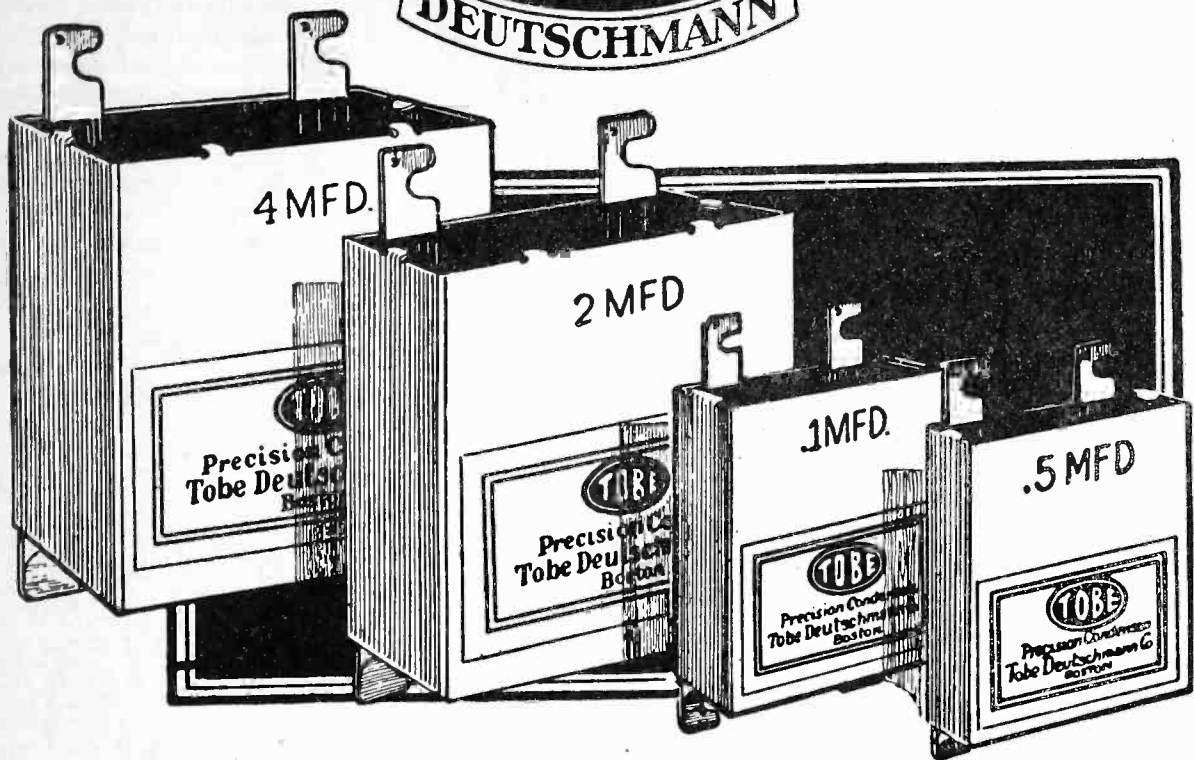

PRECISION FILTER and BI-PASS CONDENSERS

THE standard smoothing condensers for use in A and B Eliminators, for by-pass condensers in all radio sets, and for coupling condensers in resistance and impedance coupled audio amplifiers.

- Accurate to within 5% of rating.
- 700 volt high-tension insulation.
- Long life.
- Unaffected by extreme heat or cold.
- Shielded metal cases with beautiful matt silver finish.
- Packed in the new and distinctive silver cartons.

These are the reasons TOBE CONDENSERS are pre-eminent in Radio and allied electrical fields.

For the Raytheon Plate Supply Unit, use

2 type 705—0.1 Mfd.—Price.....	\$.70
1 type 707—0.5 Mfd.—Price.....	.90
2 type 709—2.0 Mfd.—Price.....	1.75
2 type 711—4.0 Mfd.—Price.....	3.75

TOBE CONDENSERS are specified by Edwin E. Turner in RADIO for November, 1925—by Gerald M. Best in RADIO for December, 1925—Roland M. Beers in Radio Broadcast for December, 1925—and by Laurence M. Cockaday in Popular Radio, November, 1925.

“THE BETTER CONDENSER”

The TOBE DEUTSCHMANN line also includes Transmitting Condensers and Transmitting Tubes. Send for circulars.

San Francisco Office—821 Market Street, San Francisco, Calif.

Tobe Deutschmann Co.

CORNHILL BOSTON MASS.

West of the Rockies
PRICE
\$26.50

TOBE DTW LOOP

(collapsible)

Supreme for all loop operated circuits. The one loop in all America chosen by McLaughlin for his single control set. Has 27 inch sides. Genuine Litz wires. Graduated base for compass settings.

Made to laboratory standards for a lifetime of efficient use.

On Wings they ride the ether waves



Patented July 25, 1925; May 2, 1911

Patented July 25, 1925; May 2, 1911

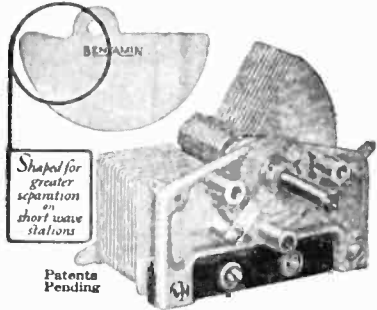

Benjamin Low Loss, Long Range Condensers

First of all a wonderful low loss condenser. The shape of the rotor blades eliminates bunching of stations on the lower side of the dial and makes tuning very easy. Unpolished silver plate finish. Friction disc on rotor shaft adjusts turning tension without loosening or throwing plates out of alignment. Made in three sizes: 13 plate for .00025 Mfd., 17 plate for .00035 Mfd., and 25 plate for .0005 Mfd. Drilling template furnished with each condenser.



Benjamin Tuned Radio Frequency Transformers

Even in what has been considered an excellent set, it is astounding what an improvement in tone, quality, volume and selectivity the introduction of these coils produces. Low Resistance. Low Distributed Capacity. Space wound, air core; double green silk insulation—the nearest approach to an all-air dielectric construction and the highest type of inductance possible.

Sold through Radio Jobbers and Dealers everywhere

Benjamin Electric Mfg. Co.

120-128 S. Sangamon Street, Chicago

247 W. 17th Street, New York

448 Bryant Street, San Francisco

Manufactured in Canada by the Benjamin Electric Mfg. Co. of Canada, Ltd., Toronto, Ontario

BENJAMIN CLE-RA-TONE Shock Absorbing Radio Socket

Stops tube noises. Assures clear reception. Four delicately adjusted springs support the socket and absorb all jars and shocks. The Cle-Ra-Tone Socket "floats" above its base. Bakelite, used wherever possible, insures sturdiness, long life and high insulation. Flexibility of springs is not affected by stiff bus wiring. Handy lugs make soldering easy. Benjamin Cle-Ra-Tone Sockets prevent the transmission of outside vibrations into microphonic disturbances.

"Push" Type Cle-Ra-Tone Socket

A socket made with the precision of a jeweled watch. It embodies all of the wonderful shock absorbing features and qualities of the regular Cle-Ra-Tone Socket. The "Push" Type Socket is designed to accommodate the new standard UX "push" type base radio tube. It will also take tubes with the ordinary bases, excepting the UV-199.

(Continued from Page 54)

how. After you wash up the dishes, you can sweep out all of the rooms, make my bed, wash the floor in this room, and then get dinner ready. This afternoon you can peel a bunch of potatoes and apples. Hop to it!"

Nearly the entire forenoon was taken up for Bob with the cleaning, and by the time he had gotten dinner and finished washing the dishes, he was glad of the chance to sit down to his task of peeling potatoes and apples.

But Fate was not going to let Bob have much of a rest, for no sooner had he settled himself to his work, when a loud knocking was heard on the front door.

With a glad cry, Bob rushed to the door, but "Bull" shoved him back, muttering under his breath.

"Who is it?" he growled.

"Fire! Fire! Fire!" was the startling response. "Open the door quick!"

Throwing open the door, "Bull" was pushed aside by a young fellow about eighteen years old, evidently a farmer's boy, who rushed in. The new boy dashed to the sink and seized a bucket before "Bull" could say a word, so astounded was he.

"Your roof is on fire, there's smoke coming up from the base of the chimney," the newcomer panted.

"Aw hell, that's just a leak in the pipe, no need to get excited," exclaimed "Bull" in relief.

"Whew, that was a scare," the new boy said heavily, still panting, as he sank into a chair.

"Bull" made a grimace which both boys failed to see.

"Sit down and take a rest. My name is Jones and this is my son. We were just moving some stuff upstairs as you came in, so we'll finish it. Be back in a minute. Come on, son."

Leading the way upstairs, he walked into a back room and closed the door behind himself and Bob.

"Look here, kid, see this pistol? Well there's plenty of bullets in it, and you're going to get one of them if you pull any boners while that other fellow is in the house. Get me?"

Taking the reply for granted, he again led the way to the lower floor, and closing the door, he sat down and offered the boy a cigarette, which was refused. Bob immediately went back to his peeling, this time sitting at a table.

All three talked for a few minutes, and then all at once Bob's heart gave such a leap that his face changed color. For there on the lapel of the newcomer's coat was an emblem identical to the one on his own coat—signifying that both boys were members of a national association of radio amateurs, most of whom

(Continued on Page 58)



DON'T WAIT! Pep Up That Set Now With X-LVARIO DENSERS

Install them in your receiver and hear them speak for themselves

SPECIFIED BY GERALD M. BEST

Endorsed and Used by the Foremost Radio Engineers

SPECIAL FOR MODIFIED 45000 CYCLE SUPERHETERODYNE, CAP. RANGE .00002 TO .0001 M. F., \$1.50

MODEL N—Capacity range 1.8 to 20 micro-microfarads for balance in Roberts two tube, Browning-Drake, McMurdo Silver's Knockout, Neutrodyne and tuned radio frequency circuits. Price, \$1.00

MODEL C—Two capacity ranges. 00016 to .00055 and .0003 to .001 Microfarads, for the Cockaday circuit, filter and intermediate frequency tuning in superheterodyne and positive grid bias in all sets. Price, \$1.50

X-L RADIO LABORATORIES

2426 Lincoln Avenue

CHICAGO

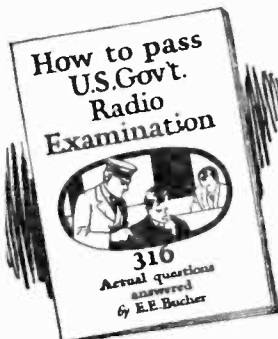

PASS the U. S. Government Commercial or Amateur Radio License examination! This book will help you do it! Send sixty cents in stamps or coin for your copy—postage prepaid to any point in the U. S., Canada or Mexico.

For a Short Time Only **60c**

RADIO INSTITUTE OF AMERICA
322 Broadway, New York City

ARE YOU A SUBSCRIBER?
SEND FOR TRIAL SUBSCRIPTION
\$1.00 FOR SIX MONTHS

The *NEW* NATIONAL EQUICYCLE Condenser

The latest development in straight line frequency control as applied to NATIONAL Condenser design. Increases range of rotation from 180° to 270°, permitting more precise adjustment and sharper separation of stations, and accomplishes this WITHOUT GEARS, CAMS AND LEVERS.

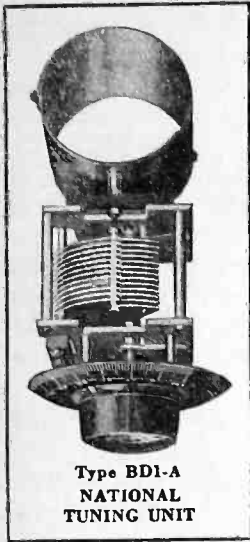

Type BD1-A
NATIONAL
TUNING UNIT

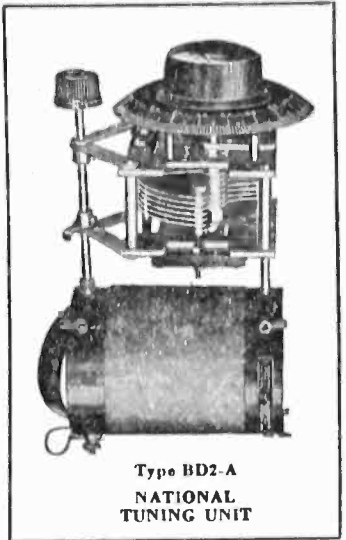

Type BD2-A
NATIONAL
TUNING UNIT

*It changes
a mob
into an
orderly
procession*

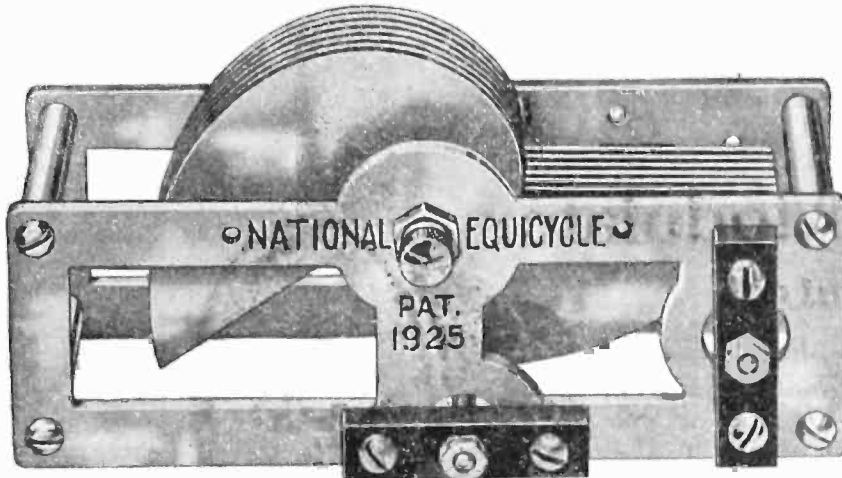

(Patented February 10, 1925)

*and
lengthens
the line
of
march!*

Tests Conducted at Crufts Laboratory, Harvard University, by Prof. Field, give characteristics of the new Equicycle Condenser as indicated by the following graph:

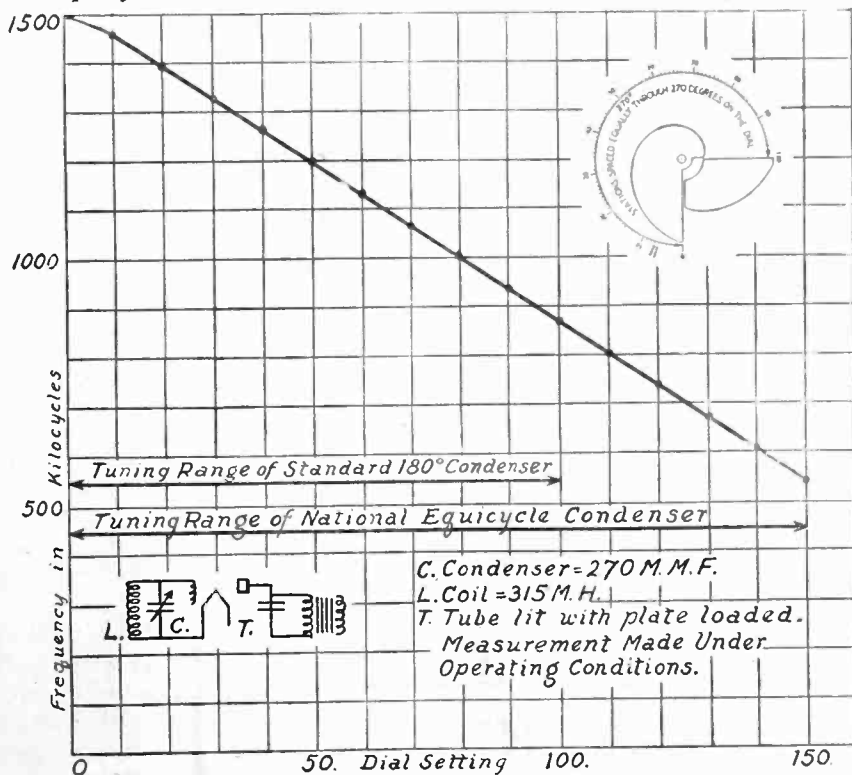

—The novel shape of the plates spaces the station groups at equal intervals of 10 kilocycles (as specified by the U. S. Department of Commerce) in a true straight frequency line.

—The same electrical efficiency and mechanical ruggedness that have always characterized NATIONAL DX Condensers have been embodied in the *new* NATIONAL EQUICYCLE Condenser.



Type B
NATIONAL VELVET
VEDNIER DIAL

Get the Genuine. Insist upon NATIONAL COMPANY'S RADIO Products. Your dealer appreciates your patronage and will gladly get them for you. Write for Bulletin 111-R

NATIONAL COMPANY, Inc.

W. A. READY, PRESIDENT

110 Brookline St.

Cambridge, Mass.

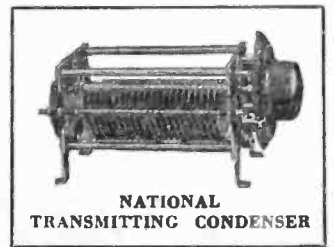

NATIONAL
TRANSMITTING CONDENSER

Centralab Radiohm for Oscillation Control

THE Centralab Radiohm gives you perfect oscillation control—enables you to get full efficiency from your radio set.

By controlling oscillation with this little unit, you can hold that sensitive regenerative position which immediately precedes the oscillation point, without distortion or loss of selectivity. Think what a boon to clear, true-tone reception this is!

The Radiohm provides smooth variation of resistance from zero to 200,000 ohms. Ideal for plate circuit control of oscillation. Used as a standard unit in many leading commercial sets. Price: \$2.00.

Centralab Modulator for Volume Control

This improved type of potentiometer takes the "rough spots" out of volume—smooths out powerful "locals" as well as difficult "DX." It provides noiseless control of tone volume without in any way affecting the tuning of your set. Has a maximum resistance of 500,000 ohms, specially tapered to give smooth, even control from a whisper to full volume—or vice versa—without de-tuning.

Can be used in audio circuits with any transformers or with Thordarson "Autoformers." Endorsed by Thordarson Electric Mfg. Co. Price: \$2.00.

Mail the coupon

Central Radio Laboratories

14 Keele Avenue, Milwaukee, Wis.

Centralab

CENTRAL RADIO LABORATORIES, 14 Keele Ave., Milwaukee, Wis.

Send me literature describing Centralab controls. Enclosed find \$_____ for which please send me the following:

Centralab Modulator, at \$2.00 each. Centralab Radiohm, at \$2.00 each.

Name _____

Address _____

BAKELITE PANEL ENGRAVING VOLNEY G. MATHISON & CO.

660 Twelfth Street, Oakland, California

Bakelite Panels, Sheets and Tubing, Bakelite
Cutting, Drilling and Superfine Engraving

Special Machine Service, Lathe-work, Drilling, Forming Brackets, Shields, Etc.
Manufacturers of Coils for Roberts, Browning-Drake, Neutrodyne, Reflex, Super-
het Oscillators, and All Circuits.

WRITE FOR PRICE LISTS—WHOLESALE AND RETAIL

(Continued from Page 56)

were familiar with the code system used in wireless telegraphy.

Calming himself, Bob mentioned the emblem to the other boy.

"Oh yes, I have belonged for some time. I've got a good 'ham' set at home. Have you got one too?"

"You bet," replied Bob, "come on over here to the table and we'll talk about our sets."

The two boys went into a discussion of the relative merits of so many sets, that "Bull," trying to follow them, became disgusted and sat watching the fire in moody silence.

Meanwhile Bob went on peeling potatoes, toying with the peels on the table. A close observer would have noted, however, that the peels that Bob was toying with were all of two sizes, half of them about two inches long, and the others about one inch long.

After about half an hour had gone by, "Bull" suddenly came out of his reverie to hear Bob exclaim, "May God help me!"

"What's that? What are you talking about?" demanded Bull.

"Oh, I was just telling him how good my radio set is and he didn't believe me," Bob lied bravely.

"Bull," satisfied with the answer, again turned to the fire. Had he been a mind-reader, he would have put a much different meaning on Bob's exclamation, for being a mind-reader, or even a radio man, he would have seen what those potato peels meant, placed in code formation.

After a few minutes, the new boy rose to leave, telling Bob that he would see him later. Giving him his hat, "Bull" opened the door and the boy went on his way.

"That was good work kid. I see you got the potatoes and apples peeled too. You'll make a good kid some day," was "Bull's" approving remark as he sat down again. "Better get to work on supper now."

The supper was soon out of the way, and after the dishes had been washed and the room straightened, "Bull" told Bob to make ready for bed.

"Sorry to have to do this, kiddo, but I can't take chances," "Bull" said as he again locked Bob in his room. "Better go to sleep because you'll have to get up early in the morning. Good night."

Fate, or the results of Bob's brain work, had other plans for the night though, for no sooner had Bob climbed into bed than he heard shouting and pounding on all sides of the house, accompanied by several shots.

"Come out of there, "Bull" Dolt, we've got you surrounded and we'll shoot holes through the house if you don't hurry up and bring Bob O'Connor out."

(Continued on Page 60)



ZENITH

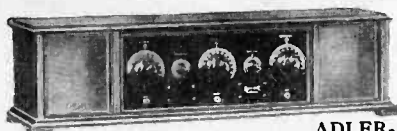

ADLER-ROYAL

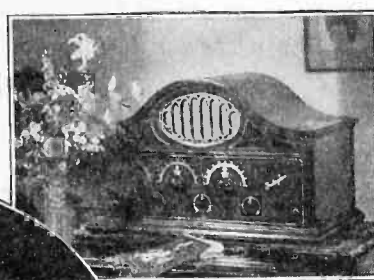

BUCKINGHAM



DERESNADYNE

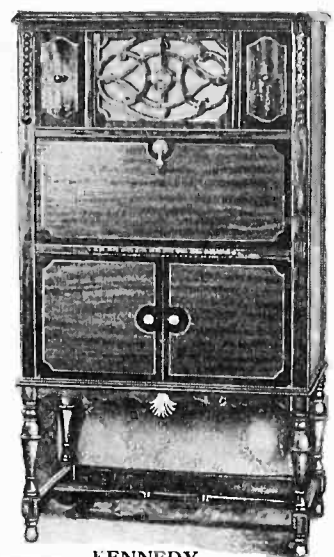

KENNEDY



PRECEL



MOHAWK

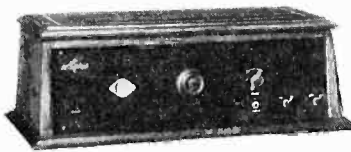

PFANSTIEHL

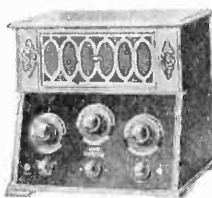

GLOBE



MUNN-LANDON



MURDOCK



NEUTROWOUND



THERMIODYNE

Standard on the finest

THORDARSON

Super
AMPLIFYING TRANSFORMERS

THORDARSON ELECTRIC MANUFACTURING CO. *Chicago, U.S.A.*

WORLD'S OLDEST AND LARGEST EXCLUSIVE TRANSFORMER MAKERS



RADIODYNE



MERCURY



HUNTINGTON

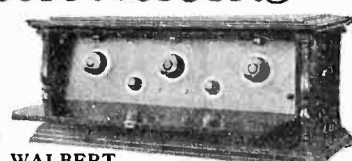

WALBERT



MU-RAD



WRIGHT DE COSTER



NEWPORT

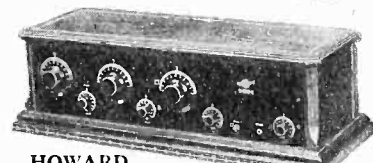

HOWARD



DRAY



HARTMAN

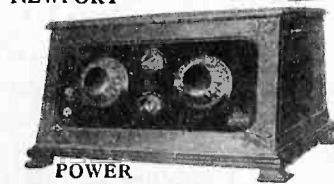

POWER

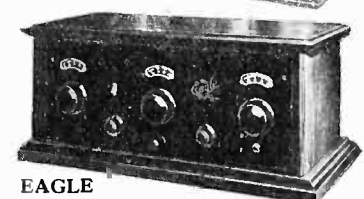

EAGLE



VALLEY-TONE



ECHOPHONE

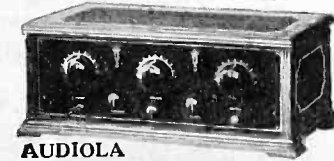

AUDIOLA



SUPERIOR



ELKAY

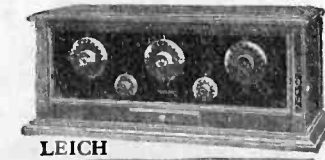

LEICH



OZARKA



SILVER-MARSHALL

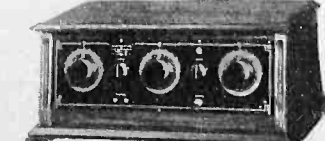

TORODYNE

Tell them that you saw it in RADIO

those*
 who know
 recommend

AEROVOX

Fixed
 Condensers

* Tested and approved by M. I. T., Yale, Radio News, Popular Radio and Popular Science.
 Used by over 200 of America's leading set manufacturers.
 Made in all capacities. Also manufacturers of Grid Leaks, Resistors, Resistofomers and Rheostats.

another reason why you should insist on them

AEROVOX WIRELESS CORP., 489 Broome Street, New York City

Chicago Office: 53 W Jackson Boulevard

Western Representatives: RICE-HITT CO., SAN FRANCISCO-LOS ANGELES



Lastite
 Centered Terminal

If your object is to attain excellence in radio structure, the basic importance of the Lastite will interest you as much as it does us.

"With a bus wire soldered to it, the Lastite is its own lock nut."

There can be no structural element in radio more basically important than this feature of the Lastite.

Lastites hold the bus wires and, so, help while you arrange them.

The Lastite is easier to solder than a lug, is easier to put on, is stronger and looks incomparably better than any other kind of terminal.

Being more than just a contact, the Lastite is the only radio terminal which can be advertised and recommended, on its merits, for the service it performs.

Distributors and dealers, write for proposition.

PATENTS APPLIED FOR
 Write or telegraph for samples

William Stevens Co., ★
 27 Hammatt Road Roslindale, Mass.

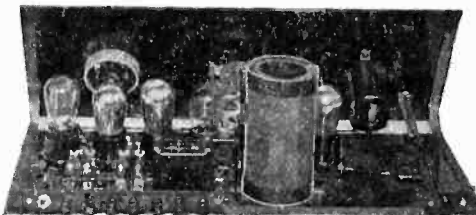

**USED IN THE
 LC-26 RECEIVER**

The Precision Octaform Coil shown above is the only coil that can be used in Mr. Cockaday's new LC-26 Receiver. Price, \$5.50.

**THE COCKADAY
 LC-26 RECEIVER KIT**

For the convenience of those consumers and dealers who wish to buy the Cockaday LC-26 in complete kit form, we offer the following parts exactly as used in Mr. Cockaday's laboratory model. Price complete with solid walnut cabinet, \$81.90.

Parts for the Cockaday "B" Eliminator (Raytheon Plate Supply Unit) may be obtained exactly as specified in November Popular Radio. Price, \$42.05.

DEALERS—Write for information on coils and kits.

PRECISION COIL CO., INC.
 209 Centre Street, New York, N. Y.

(Continued from Page 58)

With a feeling of joy, Bob recognized the voice of Sheriff Carter, and began to pound the wall to attract attention.

Upstairs, "Bull," pausing to argue through a window for a few moments, realized the impossibility of holding off the rescue, and came downstairs to unlock the door to Bob's room.

"Kid, if I didn't know that you couldn't have had anything to do with getting the sheriff here, I'd bump you off right now. Come on and I'll let you out, and remember that I didn't treat you mean."

With an open door in front of him, Bob could not resist rushing out, and he fell right into the arms of his father, who whisked him back to town and his waiting mother, in a fast car.

The next morning at breakfast, Bob seeing his chance, started to broach the subject of learning to be radio operator. But his mother anticipated him, for no sooner had he opened his mouth to speak than she agreed.

"Yes Bob, you can have anything you want. Both you and that other boy are going to get two sets just like the ones in Allen's window, and you can start at the radio school tonight. And when you finish the radio school, you can teach your father too. I think that every man ought to know something about radio, don't you Dad?"

"You bet your life!" Dad replied with a sly wink at Bob.

THE TIME TOTALER

(Continued from Page 20)

wheel must be coupled to the shaft through some sort of coupling to the little knob at the back. The best way is to remove the glass from the front of the clock and drive the wheel by bending the minute hand to engage a slot in the wheel.

The counter is fastened on a movable iron strip, pivoted at the bottom. An electromagnet is so arranged that current through it causes the iron strip to be attracted, and the counter with its wheel to touch the drive wheel. This electromagnet may be of any convenient size and is connected to the filament supply.

Things must be nicely balanced to eliminate as much friction as possible. The clock must be freshly wound before commencing hostilities every evening or else the thing will stop. It may be necessary to fasten the clock down. These and other minor details and changes will suggest themselves to anyone constructing the Time Totaler.

"Cold solder" for use in places difficult of access with a soldering iron can be made by mixing a stiff paste of common solder filings with a small amount of mercury.

The Air Line Radio Map and Log
Great Help and Time Saver

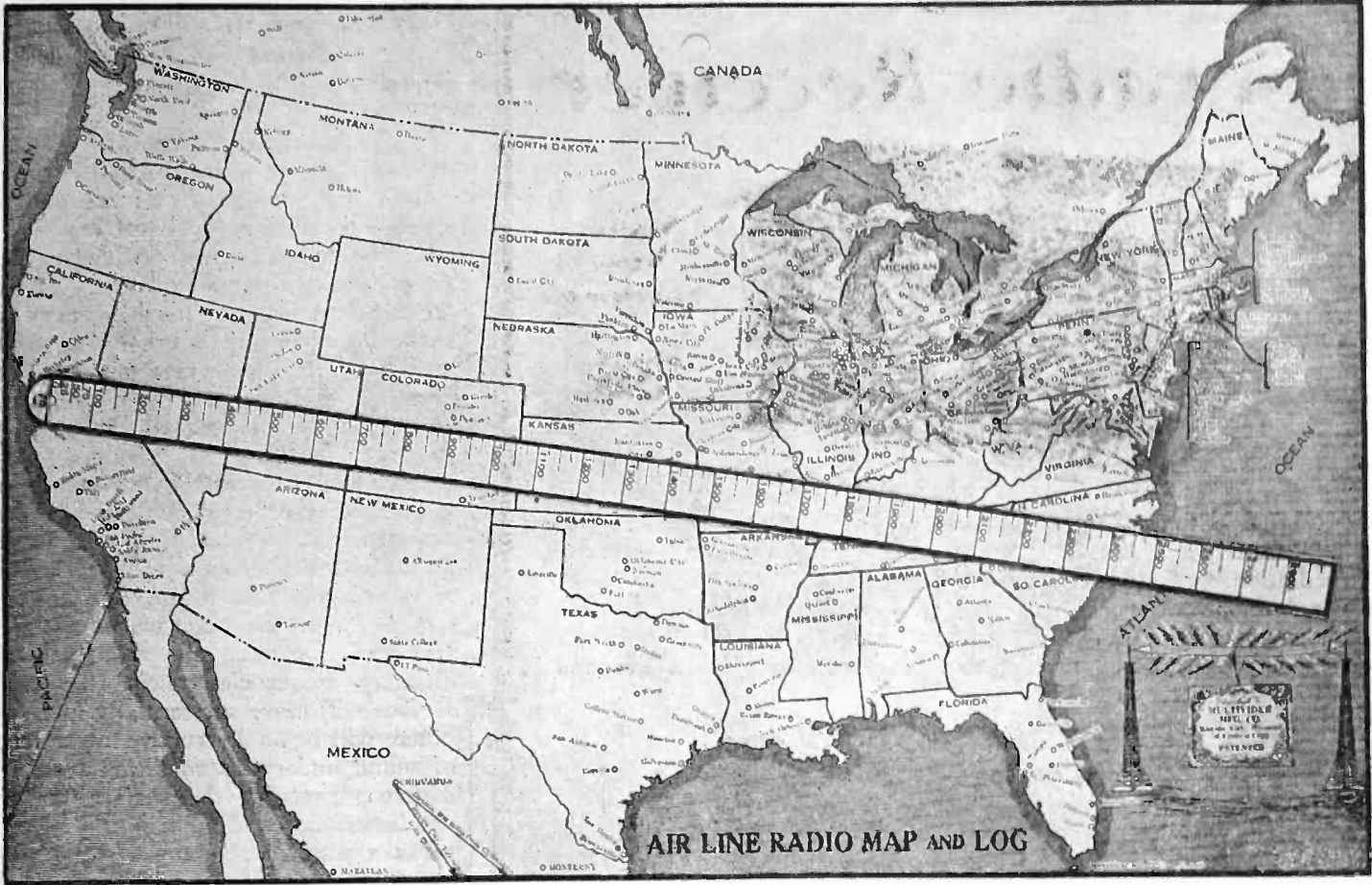

MARVELOUS NEW RADIO LOG



Not a big bill poster. Large enough to find what you are looking for. Easy to handle and read. Neat enough so the women folks will be proud to let you hang it anywhere in the home.

Here is a real air line radio map and log. One that will not be obsolete in a month because it's revised regularly by monthly supplement service for a whole season. The illustrations tell only a small part of the story. You have to see this book to appreciate its value. Lists stations by call letters, also by wavelengths. **UNIQUE BROADCASTING SCHEDULE.** Log shows location, difference in time, power, meters and kilocycles; spaces to list dial settings, time heard, distance, signal strength, whether you use outdoor aerial or loop. Individual log for every station. If your dealer cannot supply you, send 50 cents for a copy today.

50 Cents

Air Line Radio Map and Log

EXPLANATION OF KEY TO BROADCASTING SCHEDULES

Requires a knowledge of radio schedules as "Daily excepting Sunday" from 8 P. M. until 11 P. M. must be used. "Sunday, Wednesday and Friday" from 8 A. M. to 11 P. M. "Monday, Tuesday, Thursday, Saturday" from 8 P. M. until 11 P. M. "Daily" from 8 P. M. until 11 P. M. "Daily excepting Sunday" from 8 P. M. until 11 P. M. "Daily excepting Sunday and Friday" from 8 P. M. until 11 P. M. "Daily excepting Sunday, Wednesday, and Friday" from 8 P. M. until 11 P. M. "Daily excepting Sunday, Wednesday, Thursday, and Friday" from 8 P. M. until 11 P. M. "Daily excepting Sunday, Wednesday, Thursday, and Friday" from 8 P. M. until 11 P. M.

KEY NUMBER-DAY

- 1 Monday
- 2 Tuesday
- 3 Wednesday
- 4 Thursday
- 5 Friday
- 6 Saturday
- 7 Sunday
- 8 Daily excepting Sunday
- 9 Daily excepting Sunday and Friday
- 10 Daily excepting Sunday and Wednesday
- 11 Daily
- 12 Daily excepting Sunday and Friday
- 13 Daily excepting Sunday and Thursday
- 14 Daily excepting Sunday
- 15 Daily excepting Thursday
- 16 Daily excepting Sunday and Monday
- 17 Daily excepting Sunday and Friday
- 18 Daily excepting Wednesday

KIND OF BROADCASTING

- 1. V.H.
- 2. V.L.
- 3. Daylight
- 4. Night
- 5. Daylight
- 6. Night
- 7. Daylight
- 8. Night
- 9. Daylight
- 10. Night
- 11. Daylight
- 12. Night
- 13. Daylight
- 14. Night
- 15. Daylight
- 16. Night
- 17. Daylight
- 18. Night
- 19. Daylight
- 20. Night
- 21. Daylight
- 22. Night
- 23. Daylight
- 24. Night
- 25. Daylight
- 26. Night
- 27. Daylight
- 28. Night
- 29. Daylight
- 30. Night
- 31. Daylight
- 32. Night
- 33. Daylight
- 34. Night
- 35. Daylight
- 36. Night
- 37. Daylight
- 38. Night
- 39. Daylight
- 40. Night
- 41. Daylight
- 42. Night
- 43. Daylight
- 44. Night
- 45. Daylight
- 46. Night
- 47. Daylight
- 48. Night
- 49. Daylight
- 50. Night
- 51. Daylight
- 52. Night
- 53. Daylight
- 54. Night
- 55. Daylight
- 56. Night
- 57. Daylight
- 58. Night
- 59. Daylight
- 60. Night
- 61. Daylight
- 62. Night
- 63. Daylight
- 64. Night
- 65. Daylight
- 66. Night
- 67. Daylight
- 68. Night
- 69. Daylight
- 70. Night
- 71. Daylight
- 72. Night
- 73. Daylight
- 74. Night
- 75. Daylight
- 76. Night
- 77. Daylight
- 78. Night
- 79. Daylight
- 80. Night
- 81. Daylight
- 82. Night
- 83. Daylight
- 84. Night
- 85. Daylight
- 86. Night
- 87. Daylight
- 88. Night
- 89. Daylight
- 90. Night
- 91. Daylight
- 92. Night
- 93. Daylight
- 94. Night
- 95. Daylight
- 96. Night
- 97. Daylight
- 98. Night
- 99. Daylight
- 100. Night

DIFFERENCE IN TIME

1. 15 min. 2. 30 min. 3. 45 min. 4. 1 hr. 5. 1 hr. 15 min. 6. 1 hr. 30 min. 7. 1 hr. 45 min. 8. 2 hr. 9. 2 hr. 15 min. 10. 2 hr. 30 min. 11. 2 hr. 45 min. 12. 3 hr. 13. 3 hr. 15 min. 14. 3 hr. 30 min. 15. 3 hr. 45 min. 16. 4 hr. 17. 4 hr. 15 min. 18. 4 hr. 30 min. 19. 4 hr. 45 min. 20. 5 hr. 21. 5 hr. 15 min. 22. 5 hr. 30 min. 23. 5 hr. 45 min. 24. 6 hr. 25. 6 hr. 15 min. 26. 6 hr. 30 min. 27. 6 hr. 45 min. 28. 7 hr. 29. 7 hr. 15 min. 30. 7 hr. 30 min. 31. 7 hr. 45 min. 32. 8 hr. 33. 8 hr. 15 min. 34. 8 hr. 30 min. 35. 8 hr. 45 min. 36. 9 hr. 37. 9 hr. 15 min. 38. 9 hr. 30 min. 39. 9 hr. 45 min. 40. 10 hr. 41. 10 hr. 15 min. 42. 10 hr. 30 min. 43. 10 hr. 45 min. 44. 11 hr. 45. 11 hr. 15 min. 46. 11 hr. 30 min. 47. 11 hr. 45 min. 48. 12 hr. 49. 12 hr. 15 min. 50. 12 hr. 30 min. 51. 12 hr. 45 min. 52. 13 hr. 53. 13 hr. 15 min. 54. 13 hr. 30 min. 55. 13 hr. 45 min. 56. 14 hr. 57. 14 hr. 15 min. 58. 14 hr. 30 min. 59. 14 hr. 45 min. 60. 15 hr. 61. 15 hr. 15 min. 62. 15 hr. 30 min. 63. 15 hr. 45 min. 64. 16 hr. 65. 16 hr. 15 min. 66. 16 hr. 30 min. 67. 16 hr. 45 min. 68. 17 hr. 69. 17 hr. 15 min. 70. 17 hr. 30 min. 71. 17 hr. 45 min. 72. 18 hr. 73. 18 hr. 15 min. 74. 18 hr. 30 min. 75. 18 hr. 45 min. 76. 19 hr. 77. 19 hr. 15 min. 78. 19 hr. 30 min. 79. 19 hr. 45 min. 80. 20 hr. 81. 20 hr. 15 min. 82. 20 hr. 30 min. 83. 20 hr. 45 min. 84. 21 hr. 85. 21 hr. 15 min. 86. 21 hr. 30 min. 87. 21 hr. 45 min. 88. 22 hr. 89. 22 hr. 15 min. 90. 22 hr. 30 min. 91. 22 hr. 45 min. 92. 23 hr. 93. 23 hr. 15 min. 94. 23 hr. 30 min. 95. 23 hr. 45 min. 96. 24 hr. 97. 24 hr. 15 min. 98. 24 hr. 30 min. 99. 24 hr. 45 min. 100. 25 hr.

Note the mass of timely radio data on each page. The complete listing of stations is kept up-to-date with the monthly supplement service.

Call Letters	NAME AND ADDRESS OF RADIOCASTER	Meter Length	Power (Watts)	Kilo-cycles	Time Heard	Distance	Controls			Out-door Ant.	Loop Direction	Ph. or Load Spkr.	Sig-nals	Kind of Time	BROADCASTING SCHEDULE (See back of map for code.)
							1	2	3						
KDKA	Westinghouse Electric Co. E. Pittsburgh, Pa.	309.1	1000	970										ET 1-3-5-6-L-Q-Z, 2-L-O-Z; 4-1-W-Z, 7-E-I-Z.	
KDLR	Radio Electric Co. Devils Lake, N. Dak.	231	5	1800										CT 9-AA-44; 9-B-Z-21; 9-Q-AA-2-38; 1-O-W-Z; 7-SS-A-Z.	
KDPM	Westinghouse Electric Co. Cleveland, Ohio	250	750	1200										ET	
KDYL	New House Hotel Salt Lake City, Utah	245.8	50	1220										MT 9-MM-QQ-Z, 9-C-1-Z-22-34 7-U-V-EE-Z.	
	Frank Siefert Calif. Rock Auto Co.	209.7	100	1430										PT 9-1-M-Z-22.	

The above illustration shows the method of recording station data. Note how complete it is. Enables you to look up and record any information almost instantly. Each map packed in an individual envelope. Back has a series of appreciation cards to be sent to broadcasters when a good concert is heard. The log includes a complete list of foreign and Canadian stations.

The log gives you a list of stations alphabetically by call letters as well as by towns. This enables you to find a station's location in a hurry. Nothing complicated about this marvelous method.

DEALERS--

Order now at regular trade discounts. National advertising will create a big demand for this handy log and map.

MULTIVIDER CO., Askew and St. John Avenue, KANSAS CITY, MO.

Superadio Receiver

5
Tubes

2
Dials

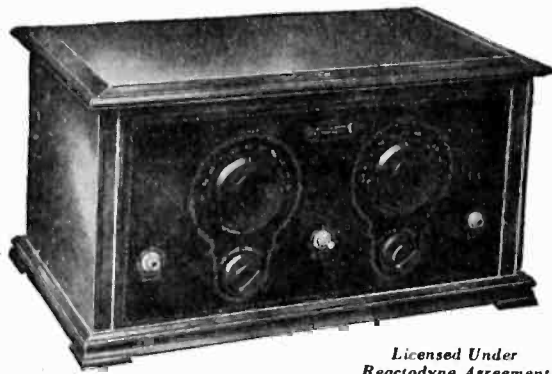

Many
New
Features

\$56

Licensed Under
Reactodyne Agreement

MATCHLESS tone quality is obtained in the Superadio Receiver due to the Reactodyne System of R. F. Amplification by which automatic control of oscillation is effected over the entire broadcast range. As the result of exhaustive development work, each tube performs the maximum amount of work, assuring greater volume and greater distance. Housed in a beautiful walnut cabinet with gold engraved panel. Very easy to operate. Economical upkeep. Truly marvelous results.

*Ask to see the Superadio at your dealer's or
write us for full details.*



Superadio Dynamometer
equipped with phones and
plug. Price \$120.
(Patents Pending)
Liberal Discounts.

→ [*Just Out!*
The Perfected Superadio B
Battery Eliminator.] ←

Buy TESTED Tubes

Insist that your tubes are TESTED. The Superadio Dynamometer tests tubes so you can understand it. Direct reading, it measures the amplification factor, plate impedance and mutual conductance without curves or calculations. Accurate. Rapid.

SPECIAL AMPLIFIER (Model S-2)

For use with the wonderful Superadio Dynamometer eliminating the headphones \$30.

De WITT-La FRANCE Co., Inc.

54 Washburn Ave., Cambridge, Massachusetts

Boston Representative:
Martin, Hartley & De Witt Sales Co., 99 Bedford St.

Chicago Representative:
William A. Welty & Co., 36 So. State St.

Burns LOUD SPEAKER With Concert Unit

The large size of this Unit gives great range with tone of most pleasing quality, which, combined with the special amplifying properties of the Burns horn, produces remarkable results. A speaker that will add to the enjoyment of any receiving set. Pleases the eye as well as the ear.

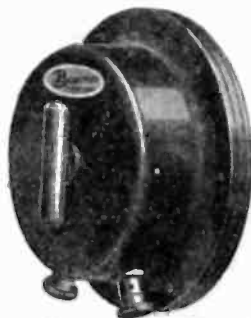

Horn is of a distinctive design with pyralin flare in several handsome finishes.

No. 205B—With Black Flare.....	\$22.50
No. 205D—Mahogany Tinted Flare.....	25.00
No. 205P—Mother-of-Pearl Flare.....	30.00
No. 100 —Medium Phonograph Unit.....	10.00
No. 120 —Concert Phonograph Unit.....	12.00

At your dealer's, or write direct to manufacturers.

American Electric Company

State and Sixty-fourth Streets

CHICAGO, U. S. A.

HORNLESS LOUDSPEAKERS

(Continued from Page 24)

determining role to play in the flexural vibrations.

To obtain large vibrations (and therefore under proper conditions intense sounds) we should select light materials—the lightest it is possible to obtain. We should select materials which are not too stiff nor too flexible. To obtain lightness one might select very thin rubber or paper but they would have too much flexibility. We must make a compromise, therefore, between lightness and flexibility to get the best sound radiation.

To avoid resonance in the vibrating surface, the speed at which these flexural vibrations travel out from the center must be great enough to prevent the wave reflected back at the edge from interfering with the direct wave until high frequencies at least are reached. For ordinary frequencies, then, the whole surface will move substantially in phase. There will be no destructive interference of sound under this condition from the different parts of the surface for the whole surface will be moving substantially as a piston or plunger. The total weight of the surface and its stiffness to plunger action will then determine the maximum possible sound output. To get this maximum output, we must reduce the weight and stiffness, here referred to, to a minimum.

If we can get light surfaces and at the same time very, very small elastic restoring forces, then we can, theoretically, get an ideal loud speaker, which is one which gives out the same amount of sound at all frequencies. These statements indicate in a general way what we are seeking for. Recent results are pretty close to this ideal which is theoretically obtainable with vibrating surfaces.

We have referred to the flat surface. Thus far good results have been obtained with flat surfaces provided they approach the conditions laid down above. Better results, however, have been obtained with surfaces, other than flat. A familiar shape of surface to be used is the conical one. Many manufacturers have put out conical loud speakers for they found it an easy manufacturing proposition and at the same time its physical properties, as a cone, give characteristics which approach to a surprisingly close degree the ideal conditions laid down above. It is worth our while, then, to consider a surface of conical shape in order to see what may be accomplished.

Conical surfaces, both large and small, have been in use for years in connection with horns. Their use without horns, however, is of comparatively recent date. A cone has rigidity in the direction of its axis. If, for example the base of the cone rests upon a flat surface and one presses upon the apex, a certain

(Continued on Page 64)

The World's Greatest Radio Story



Ward's New Radio Catalogue is Now Ready

Are you interested in seeing what is new in Radio— what is best and what has been approved?

And do you wish to know the lowest prices on tested sets, prices made without the usual "Radio profits?"

This Catalogue is a Complete Guide to Radio

Ward's is headquarters for Radio, with probably the largest retail radio department in the whole world.

This new 52 page Radio Catalogue shows everything in parts, batteries, cabinets, contains a list of stations, a radio log for recording stations. It shows the best of the new sets. One tube sets that give amazing results.

Five tube sets with a single dial to turn. Think of tuning in one station after another by turning a single dial!

Every price quoted means a big saving to you. Everything offered is tested by our own Radio Experts. In fact, the best experts compiled this Catalogue for you.

Write for this 52 Page Book. It is yours free.

Our 53 year old Policy

For 53 years we have sold only quality merchandise under a Golden Rule Policy. You can rely absolutely upon the quality of everything shown in this Radio Catalogue.

ESTABLISHED 1872
Montgomery Ward & Co.

The Oldest Mail Order House is Today the Most Progressive
Baltimore Chicago Kansas City St. Paul Portland, Ore. Oakland, Calif. Ft. Worth

To Montgomery Ward & Co., Dept. 39-R
Baltimore Chicago Kansas City St. Paul
Portland, Ore. Oakland, Calif. Fort Worth

(Mail this coupon to our house nearest you.)

Please mail my free copy of Montgomery Ward's
New Radio Catalogue.

Name

Local address

Post office

State

The Loud Speaker Sensation...



The KODEL MICROPHONE LOUD SPEAKER

You can't tell the KODEL MICROPHONE LOUD SPEAKER from the microphone the broadcasting stations use—they are exactly alike in size and appearance.

The efficient Kodel Sound Unit, with a ingenious new snail-shell horn, mounted inside the microphone case, produces a remarkably clear, full-toned volume. Non-vibrating tone chamber absolutely eliminates distortion.

\$15 model incorporates Kodel, Jr unit; equipped with large Kodel unit \$20

\$15.00

Radio dealers everywhere have them.

THE KODEL RADIO CORP.
507 E. Pearl St. Cincinnati, O.

RECEIVERS :: SPEAKERS
HOMCHARGERS

WKRC

Owners of Kodel Broadcasting Station WKRC. Send for program

CHELSEA

Super Five \$50.00

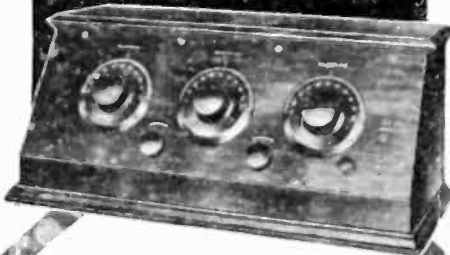

The Receiver Ideal!

Advanced engineering and years of production experience by one of the oldest radio manufacturers in the country has produced the new Chelsea Super-Five, a receiver possessing performing features and refinements of design only found in much higher priced sets.

Extreme selectivity, increased volume and splendid tone quality are obtained by an ingenious circuit arrangement, assuring dependable, uniform results. Beautiful mahogany finish cabinet and graceful sloping panel with large, convenient dials to match.

This receiver is provided with a dust-proof, fool-proof inside panel protecting the "vitals" from injury; heavy cords for making necessary connections; (no unsightly binding posts). Rugged bus-wiring throughout, with hand soldered connections.

For all-round Radio satisfaction the Super-Five is a value unrivalled.

See it at your dealer's or write for illustrated folder.

Chelsea Radio Co.
CHELSEA, MASS.

(Continued from Page 62)

amount of rigidity is observed. If the cone is rather flat, that is, has a rather large solid angle, the rigidity is much less than if the solid angle is small. If, then, the driving vibratory forces are applied in the direction of the cone's axis, the cone will tend to vibrate as a plunger or piston. The efficiency with which the cone will do this depends upon the size of its solid angle. This is due to the circular shape of the cone—the small circles giving great rigidity and the large ones small rigidity. For this same reason the cone is more rigid near the apex, than near the large end. Under extreme pressure at the apex, the base of the cone is the first part of it to collapse.

The optimum solid angle for best results is not critical. If the angle is too large the cone properties approach those of a thin, flat, flexible paper diaphragm and the results obtained from such a flexible surface are unsatisfactory. This is because such a flexible surface does not transmit satisfactorily the flexural wave on which the acoustic radiation depends. If the solid angle is very small, the rigidity of the cone is too great to obtain large flexural vibrations and hence insufficient sound is radiated. This is overcome to some extent if the cone is extended to a relatively large distance, but this introduces a "horn" quality because the cone becomes a fairly rigid paper horn which we want to avoid in these conical loud speakers. This also makes the cone too heavy to respond as a plunger efficiently.

Since the diameter of the cone becomes larger the further the distance from the apex, the stiffness of the cone becomes less and less away from the apex as explained above. For this reason the speed of the flexural vibrations decreases with increasing distances from the apex. When this flexural wave reaches the base of the cone the wave is reflected back toward the apex, just as we observe reflected waves in ropes tied to a heavy body and shaken back and forth at the other end by the hand. Just as we have destructive interference in the case of a rope, so we have the same kind of interference between the direct and reflected waves in a cone. This phenomenon, occurs at the higher frequencies but the exact place or frequency depends on the solid angle of the paper cone, its weight and other factors too. At any rate, due to the same causes as encountered in iron diaphragms resonant frequencies occur in cones. In the former the first resonant frequency occurs at about 600 cycles, but in the best paper cones these are apparently not encountered until we reach 2000 or 2500 cycles. So, resonance in a paper cone is not such a seriously disturbing factor as it is in an iron diaphragm. Hence, for all of the important frequen-

(Continued on Page 66)

ARE YOU A SUBSCRIBER?

SEND \$1.00 FOR A TRIAL SUBSCRIPTION TO "RADIO" FOR 6 MONTHS

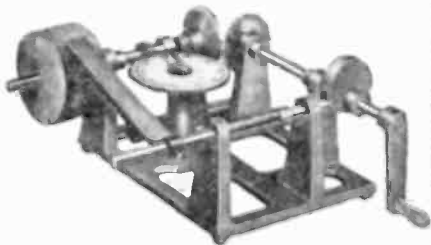

Machine for Winding Honeycomb Coils

With this machine anyone can wind their own low-loss coils to suit their particular requirements. It will wind honeycomb type coils any width from one-half inch to one inch and the inside diameter of the coil can be arranged to suit by using various sizes of wooden spools on the winding spindle. It has a recorder with an adjustable pointer for counting the number of turns. Each machine is neatly finished in black enamel and packed in an individual carton. Price \$6.00

Get Our Agent's Proposition

MORRIS REGISTER COMPANY

Successors: Morris Cash and Credit Register Company
Factory: 29th and Broadway, Council Bluffs, Iowa



Sensation of Season B-ELIMINATORS

Using New Raytheon
Tubes with



Operating a radio set is now a source of keen delight to every member of the family. Consistent performance every night is assured with the new B-Eliminators using the remarkable new Tubes and Dongan Transformers and Chokes. And anyone can build this B-Eliminator at small cost.

Indorsed by leading radio engineers and well-known magazine editors, every radio lover can now possess the simplicity and 100 percent reception possible with the new Tube B-Eliminators.

TRANSFORMERS

No. 509 Full Wave.....For RAYTHEON Tubes
No. 537 Full Wave.....For R. C. A. UX213 Tubes
No. 537 Full Wave.....For Cunningham CX313 Tubes
No. 538 Half Wave.....For R. C. A. UX216-B Tubes
No. 538 Half Wave.....For Cunningham CX316-B Tubes



List
\$7.00

Chokes

No. 514 20 henry
No. 506 30 henry
No. 539 50 henry

List **\$5.00**



Full instructions and description mailed on request. Ask your dealer or send check or money order to factory. Sold under guarantee.

FOR SET MANUFACTURERS

Dongan is the standard maker of transformers and chokes for the leading manufacturers of B-Eliminators. Engineering data and quotations furnished on request.

More than 42 of the country's leading sets use Dongan Audio Transformers. Any type you require. Your requirements can be handled promptly in our big plant. Prices on request.

Dongan Electric Manufacturing Co.
2981 Franklin Street, Detroit, Mich.

Pacific Coast Representatives:

San Francisco—

Industrial Sales Co., 171 Second Street

Los Angeles—

W. A. Breniman, 443 So. San Pedro Street

Portland, Ore.—

C. E. Gay, 166 Lewnsdale Street

Seattle, Wash.—

E. P. Donham, 2326 45th Avenue S. W.

TRANSFORMERS of MERIT for FIFTEEN YEARS



Whether You Buy or Build

Insist on Eby Cushion Sockets

The most important elements in any set are the tubes. There's no getting around that! And what else but the sockets are responsible for the life and efficiency of those tubes? Whether you build or buy, see to it that the tubes in your set are mounted on EBY Cushion Sockets.

The design of this revolutionary socket provides a three-point wiping contact on each of the four tube prongs. Each spring clip acts as a shock absorbing cushion for the tube and is securely riveted to the base eliminating all microphonic noises and protecting the tube against damage from vibration.

Furthermore, EBY Cushion Sockets, which are now ready for delivery, fit all standard tubes, including the new UX.

Manufacturers, jobbers and dealers, write for complete information.



Here is the socket that many of the foremost manufacturers and set builders depend on for 100% tube efficiency and protection. You can get them at most good dealers for, each..... **60c**

H. H. EBY MFG. COMPANY
4710 Stenton Avenue Philadelphia, Pa.
Makers of EBY Quality Binding Posts

(Continued from Page 64)

The Signal Bracket Type Loop Aerial

"It Fits In Close Quarters"

If you're crowded for room, this aerial is your best bet. Turns a full 360° in a space no wider than the width of the average cabinet. A unique space-saving arrangement enables it to become a part of your set instead of an extra piece of apparatus.

This handy Signal Bracket Type Loop Aerial matches up with all types of radio cabinets. Built of solid walnut, with all metal parts heavily nickel plated. A beautiful accessory to even the highest priced receiving set. Third tap is provided for sets requiring it. Can easily be disconnected for moving about without unmounting the bracket. Your dealer can supply you.

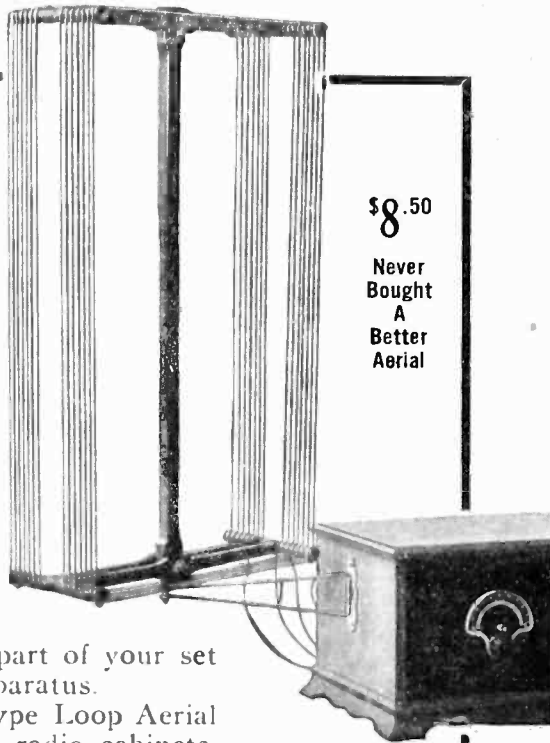

\$8.50

Never Bought A Better Aerial

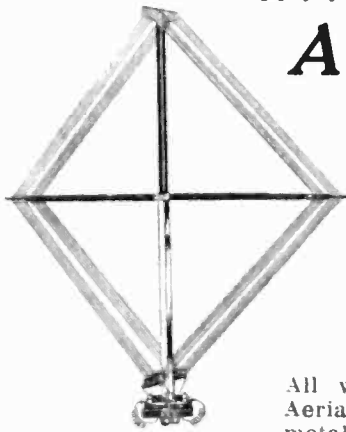

\$8.50 COMPLETE

A Result-Getter!

The Signal Table-Type LOOP AERIAL

For all-around work, this handy collapsible table type loop aerial fills the bill. No need to worry about conflicting stations with this aerial. It cuts out interference with ease—yet it does not hamper tuning by being too critical.

All woodwork on the Signal Portable Loop Aerial is of beautiful mahogany finish, with metal parts heavily nicked. Also has third tap for sets requiring it. Folds up like an umbrella when not in use. See one today.

SIGNAL ELECTRIC MANUFACTURING CO.

Dept. 3-A, Menominee, Mich.

1216 Hearst Building
San Francisco

408 San Fernando Bldg.
Los Angeles

cy ranges, cone resonance is not a matter of serious concern.

Since then we can avoid cone resonance to a large extent, we can depend on action of the cone as a whole for acoustic radiation. Let us see, therefore, what controls this type of action and hence the amount of sound radiation we can get from a cone. This is controlled by several factors which are determined first by the types of driving units or motors used, second, by the nature of the cone and third, by the method of mounting or supporting the cone. Space has not been allotted to me to go into all the factors in any great detail, but perhaps I can indicate in a general way what results may be obtained under these various conditions.

First there are three types of driving units which have been used for cones up to the present time. These include the electro-dynamic type which has a suitable coil moving in a strong magnetic field. The field has been of both the electromagnetic type and the permanent magnet type. This latter type of unit can only be sufficiently sensitive provided a strong magnetic field is available. This is obtained readily with an electromagnet but large cobalt magnets are necessary for the permanent magnet type.

The second type of driving unit used utilizes an armature driven by the signal currents with the help of strong permanent magnets. A driving rod is attached to the armature and sometimes an auxiliary rod is used to be attached to an auxiliary spring which is clamped at one end and at the other is connected to the armature by means of a small rod. The latter scheme has certain advantages over the former and enables excellent results to be obtained with small cones. That is, the size of the cone is merely one factor of many which determine the final acoustical results and any apparent superiority of large cones over small cones, can be reversed or made an inferiority by simple changes in design.

The third type of driving motor is the ordinary bipolar unit. The cone is clamped fairly rigidly so that the magnets can be brought close to an iron armature attached to the apex of the cone. If the cone were loosely clamped or freely supported, it would flop over against the magnets and operation would cease. For these reasons this drive is unsatisfactory and is too inefficient to produce good results.

The nature of the cone has a very large effect and these have been discussed to some extent above. At this point we may, however, indicate some further important factors. If the cone is freely supported, as it can be for both the electrodynamic and balanced armature types, then the results are favorably in-

Potter BY-PASS CONDENSERS

- Prevent "B" voltage fluctuation
- Allow undistorted amplification
- Make possible full bass tones
- Improve reception with "B" Supply Units.

Made in $\frac{1}{10}, \frac{1}{5}, \frac{1}{2}, 1, 2, 3$ and 4 Microfarad sizes
At Your Dealer's
POTTER MANUFACTURING COMPANY
North Chicago, Illinois

ARE YOU A SUBSCRIBER?

SEND FOR TRIAL SUBSCRIPTION

\$1.00 FOR SIX MONTHS



NO MORE LOOSE CONNECTIONS X-L PUSH POSTS

A binding post that really does excel, looks, action, service, and convenience. Push it down—insert wire—cannot jar loose from vibration. No screwing or danger of shearing off wires. Furnished attractively plated with soldering lug and necessary markings. Price, Each, 15c.
X-L RADIO LABORATORIES
2428 Lincoln Avenue Chicago



Na-ald DeLuxe Sockets are the only ones with these 3 exclusive features—lowest loss, lowest capacity and positive side-scraping contact. Send for booklet and laboratory test. Alden Mfg. Co., Dept. G11, Springfield, Mass.

fluenced. Because, in the former case, the restoring forces on the cone can be made very small. So small, indeed, that the vibrations are controlled by the weight of the cone—"inertia controlled." This type of control insures constant sound pressure at various frequencies because the amplitude of motion varies inversely with the frequency while for constant amplitude, the radiation would increase with frequency. The combined result of the two effects gives constant pressure. This is the ideal and such a loud speaker is pretty close to this ideal.

This ideal result is more difficult to approach in the case of a cone driven with a balanced armature unit. Nevertheless, I think it is possible to obtain it provided all the factors which enter the problem are clearly understood and properly controlled. We have space to merely indicate these factors which must not only be controlled but properly balanced against one another. We have, first, the stiffness of the spring which holds the armature in its balanced or neutral position. Second, we have the weight of the armature. Third, we have the length of the armature. Fourth, we have control of the distance between pole pieces and armature and hence a control of the so-called magnetic elastic forces. Fifth, we have the weight and stiffness of the auxiliary supporting spring as well as the manner of connecting the cone to this spring. This is illustrated by not only the length and size of the connecting rod but also the position of attachment along the spring. This latter determines the moment of inertia of a given cone about the main armature spring and thus exerts a strong influence on the fundamental frequency of the whole vibratory system. Furthermore, we have control of the reaction of the surrounding space on the cone. It is possible, then, to obtain with a freely supported cone and a balanced armature driving unit, a low fundamental frequency of the system and hence the desired action of the cone over a large frequency range; and over practically the whole of this range we have a "moment of inertia" controlled system just as in the case of the electrodynamic type of motor where we have an "inertia" controlled system and the results obtained are essentially alike in the two cases.

If for any reason a large cone is wanted, then we must have one set of conditions fulfilled in order to accomplish the most desirable results. However, no one wishes a large cone if such is not necessary. The same results that can be obtained with a large cone, say 12 to 15 in. or so in diameter can easily be duplicated with a 6 in. cone, or so, under properly changed conditions. To obtain this result, a barrier or baffle to prevent destructive interference was suggested, first, by the present writer some years ago while considering this phase of loud speaker reproduction. A

Made To Last

Radio tubes will continue to be used for many years, and with careful, intelligent handling and periodic flashing with the Burton and Rogers Tube Flasher they will last for many years.

So will the Burton and Rogers Tube Flasher. It is Made to Last. Its genuine Bakelite panels, resistances accurate under all conditions and wound on porcelain, baked green enamel sides;—proclaim its quality and insure its durability.

Electrically its design is based on fundamental principles and long experience and experimentation. It is the scientific development of an idea;—not an unintelligent imitation of something else.

And because *what is made right, looks right*, it is an ornament to the accessories of the most particular radio owner.

BURTON & ROGERS TUBE FLASHER

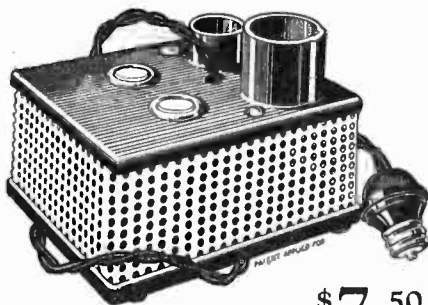

\$7.50

One Model for D. C. or A. C. All Cycles. For Tubes With Thoriated Filaments.

Burton & Rogers Mfg. Co.
755 BOYLSTON ST., BOSTON, MASS.

SEND FOR TRIAL SUBSCRIPTION
\$1.00 FOR SIX MONTHS

Yours-free!



**WRS 96-PAGE
Radio Guide Book**
Profusely illustrated and "chockful" of interest for the radio fans.
Trouble shooting chart.
List of stations and Log Chart and hundreds of
**Radio Values on a
MONEY BACK
GUARANTEE**

Your satisfaction is insured. Service and quality guaranteed or money refunded. Fill all your radio needs here—complete stock—24-hour service.
FREE A postal brings your copy. Write for it TODAY. Mention "Pacific Radio."

Wholesale Radio Service Company
6 Church Street Dept. AR-12 New York City

On to Success in RADIO!



Mr. R. L. Duncan,
Director of the
Radio Institute
of America.

RADIO is a profession well worth following. The work is interesting—fascinating. The pay is high. The demand for new men—skilled men—is strong.

You can embark, right now, on a successful career in radio. With a few months study under the expert instruction of the Radio Institute of America you can pass your U. S. Government Commercial or Amateur Radio License Examination and be ready for your first real radio job.

Study in spare time

There's no need to give up your present work. Study at home in spare time. If you really want to make a success in radio, fill in and mail the coupon to the Radio Institute of America for information on the world's finest theoretical and practical radio courses.

RADIO INSTITUTE OF AMERICA

Formerly Marconi Institute
Established 1909

322 Broadway New York City

Radio Institute of America
322 Broadway, New York City

Please send me full information about your Home Study Course of radio instruction.

I am interested in the complete course, including code instruction, which qualifies for the U. S. Gov't Commercial or Amateur Radio License.

Name.....

Address.....

Tell them that you saw it in RADIO

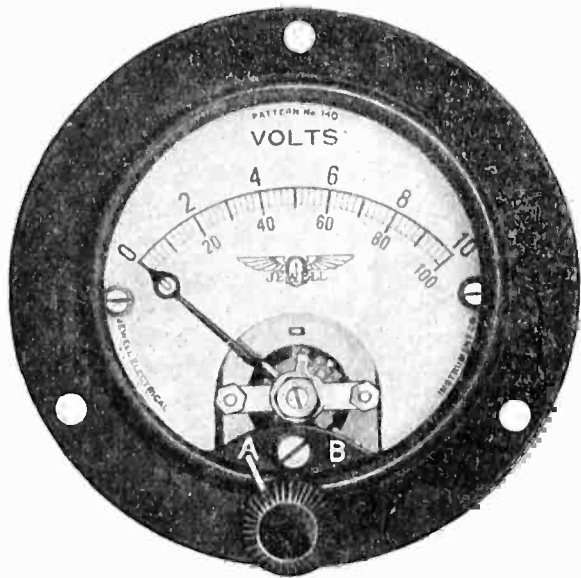

No. 140
Actual Size

Accuracy Ruggedness Quality Service

— 26 years manufacturing electrical measuring instruments have put these four cornerstones behind Jewell's reputation.

Jewell leads in radio because our engineers have studied radio problems and we have been the first to develop the instruments required.

Send for 15-B Radio Catalog

Jewel Electrical Instrument Co.
1650 Walnut Street
Chicago

ARE YOU A SUBSCRIBER?

SEND \$1.00 FOR A TRIAL SUBSCRIPTION TO "RADIO" FOR 6 MONTHS

WE SOLD 4000 SETS

Had 4000 Favorable Reports

Before We Felt Justified to Say



Quality Radio Apparatus

Now we invite you to go to your APEX Dealer who will be glad to make a personal demonstration for you in your home or in his store. A demonstration will prove to you that APEX Radio Receivers will give you everything you can possibly wish for in a radio receiver from the standpoint of selectivity, clarity, volume, distance and attractiveness of design.

- | | |
|---|--|
| The APEX Super Five \$95
Without Accessories | The APEX Utility Radio
Table \$75 |
| The APEX De Luxe \$135
Without Accessories | The APEX Entertainer (Loud
Speaker) \$22.50 |
| The APEX Baby Grand Console \$225
Without Accessories | The APEX Console Enter-
tainer \$27.50 |

Upon Request We Will Gladly Mail You Descriptive Folder

APEX ELECTRIC MFG. CO. 1410 West 59th St. Chicago

Prices West of Rockies Slightly Higher. Canadian Prices Approximately 40% Higher

Prices West of Rockies Slightly Higher. Canadian Prices Approximately 40% Higher

Northern California Distributor: UNITED RADIO SUPPLIES CO., San Francisco

Branch Offices: Seattle, Portland, Los Angeles and Salt Lake City

Western Representative: A. S. LINDSTROM CO., San Francisco, California

baffle merely makes the path from front to rear of cone longer and so the waves of opposite phases from the two sides are more nearly in phase when they meet and the destructive interference therefore is less. Certain modifications must also be made in the unit to accomplish this result. These changes, however, are readily made if one knows exactly what they should be. Perhaps another installment on this subject may be requested in which case I shall take the opportunity to present the experimental phase of the subject.

VACUUM TUBE RESISTORS

(Continued from Page 26)

microphone and its transformer will not be appreciable. Then, if the grid-leak bias is kept near zero, the change of resistance will be very great for small fluctuations of bias; also, the change of resistance will be substantially proportional to the change in bias. Another approximate proportionality exists between grid leak resistance and output power, so that the output power changes very nearly as the voltage of the grid of the grid leak. It is even probable that the two slight deviations from proportionality tend to cancel each other. The final test is of course had in actual practice, and the grid modulation system seems to stand this well.

RADIOCAST WEEKLY

Sixty-four Pages of Programs, Photos, Humor, Musical Reviews, Schedules, Tables, Editorials, Etc.

5c Per Radiocast Weekly
Copy 433 Pacific Bldg.,
SAN FRANCISCO

22½ Volt
Un-acid,
Ever-
lasting,
Recharge-
able
"B"
Storage
Battery



\$2.95
Includes
Chemical

45 volts \$5.25, 90 volts \$10.00, 112½ volts \$12.50, 135 volts \$14.75, 157½ volts \$16.80. Truly the biggest buy today. Easily charged on any current, including 32 volt systems. Any special detector plate voltage had. Tested and approved by leading authorities such as Popular Radio laboratories. Over 3 years sold on a non-refundable 30 day trial offer with complete refund if not thoroughly satisfied. Further guaranteed 2 years. Knock-down kits at great savings. Complete "Hawley" "B" battery charger \$2.75. Sample cell 35c. Order direct—send no money—simply pay the expressman cost on delivery. Or write for my free literature, testimonials and guarantee. Same Day shipments.

B. HAWLEY SMITH

316 Washington Avenue

Danbury, Conn.

And Now —
HAMMARLUND
Low-Loss
COILS



The
HAMMARLUND-ROBERTS
Unit

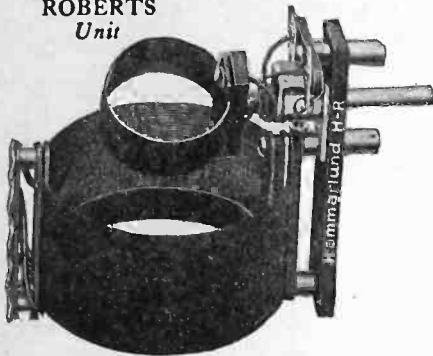

NEVER before were coils of such high efficiency available. By an ingenious process, Hammarlund engineers have devised a way to wind the famous solenoid coil with a definite space between turns, supported and anchored by a mere film of dielectric material. Thus, inductance is kept high, with low distributed capacity and absolutely no chance for short circuits.

They are regular equipment in the wonderful new Hammarlund-Roberts Receiver and the Eagle Neutrodyne. Various sizes and arrangements are available for other standard circuits.

Write for Descriptive Folder

Hammarlund Mfg. Co.
424-438 W. 33rd St., New York

Pacific Coast Representatives:
ATLANTIC & PACIFIC AGENCIES CORP.
383 Brannan St., San Francisco

For Better Radio
Hammarlund
PRECISION
PRODUCTS

"Quality Is Season's Watchword"

"Fidelity of Tone Production Will Be Greatest Public Demand this Fall"—*Radio Retailing*, issue of August, 1925.

Radio Retailing asked one hundred dealers in ten states what was the most important thing in Radio today.

They all said "Tonal quality is the first requisite."

For years Daven has pioneered quality. It is gratifying to see our vision come true and our judgment substantiated.

Daven engineers have long recognized that the present day receiving set needed to be greatly improved from a quality standpoint. They worked

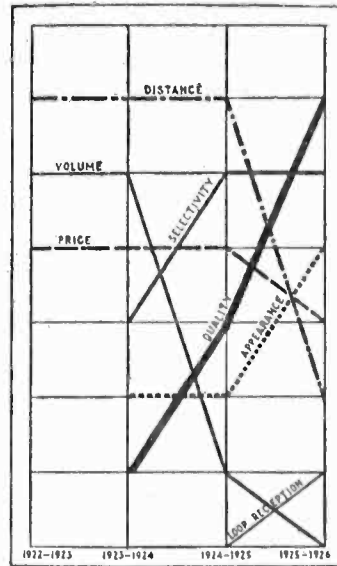

A graph from August issue of *Radio Retailing*, showing the most important selling point of Radio from 1922 to date.

and perfected Resistance Coupled Amplification, the only existing method known whereby you can procure amplification without distortion and no distortion means simply quality.

The Daven Resistance Coupled Amplifier shown below can be conveniently added to any existing set owned by the public. Manufacturers and amateur set builders should also investigate Daven Resistance Coupled Amplification. Your set will not be 1926 Model unless it is Daven Resistance Coupled.

DAVEN RESISTANCE COUPLED AMPLIFICATION

To the public—Daven Resistance Coupled Super Amplifier in a genuine Bakelite base with all resistors, grid leaks and condensers inserted—\$15. In kit form, for those who like to build their own, \$9.00.

To radio dealers—Send for our complete catalog and the name of our nearest established distributor.

To set manufacturers—The facilities of our Engineering Department are yours to command. Call upon

us at any time. We can offer you constructive advice on how to improve the audio end of your set.

THE RESISTOR MANUAL is the handbook of Resistance Coupled Amplification. At your dealer's 25c. By mail postpaid 30c.

"The Sine of Merit"
DAVEN RADIO CORPORATION
Resistor Specialists
Newark, N. J. U. S. Pat. Off. New Jersey

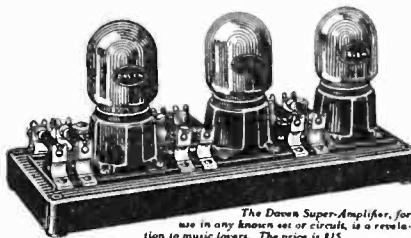

The Daven Super-Amplifier, for use in any known set or circuit, is a revelation to music lovers. The price is \$15.
DAVEN PRODUCTS ARE SOLD ONLY BY GOOD DEALERS

CLIP THIS COUPON
DAVEN RADIO CORPORATION
151 Summit Street, Newark, New Jersey
Please send me the following on Resistance Coupled Amplification:—
Check One Resistor Manual. 30c. is enclosed.
 Complete Catalogue (free).
Name.....
Address.....
For Dealers: Send your letterhead or card, or this coupon and we will have our nearest distributor communicate with you.

THE BIG LITTLE THINGS OF RADIO

ARE YOU A SUBSCRIBER?
SEND FOR TRIAL SUBSCRIPTION
\$1.00 FOR SIX MONTHS

RADIO DEALERS

Get that new catalogue
from Van Ashe!

New circuits—new parts—new sets.
All the hard-to-get items—and
extra good discounts!

Dan-Ashe Radio Co.

210 North 10th St. ST. LOUIS, MO.

The **MOLLIFORMER**
"B" UNIT
REPLACES
"B"
BATTERIES

SEND FOR complete description of this powerful "B" Unit that you can build in an hour at most reasonable cost. Use the current from the light socket—Excellent for Super and all TRF Sets—Assures greater Clarity—DX and Volume—Noiseless—No Tubes nor Acids—Utilizes full wave rectification.

Guaranteed to Give Complete Satisfaction or Your Money Refunded
PRICE
Complete Kit— \$22.50
60 Cycle Unit.....
Complete Kit— 24.50
85 Cycle Unit.....

Kits include Rectifiers.
Parts sold separately if desired.
DEALERS—Write for our proposition.
C. E. JACOBS, Sole Mnfr.
2806 N. Kedzie Avenue CHICAGO

Tell them that you saw it in RADIO

Product of over 30 years' Experience

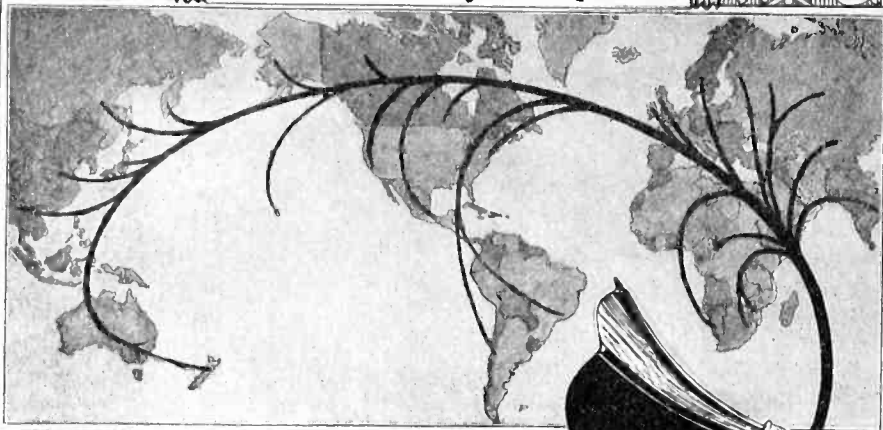

The Favorite Voice of Radio in All Tongues



TO hear an Amplion in comparison with any or all other loud speakers is to appreciate at once why Amplions are the largest selling radio reproducers throughout the world—favorites of music lovers in all lands.

The actual originators and oldest makers of loud speakers, Alfred Graham & Co., London, England, evolved The Amplion. Its superbly life-like

reproduction and supreme clarity on all notes give eloquent testimony to Graham's more than thirty years' experience in sound reproduction.

Bring out the full musical quality of your set with an Amplion loud speaker or console unit. The prices are \$12 to \$42.50. All Amplions are completely equipped with cord and panel plugs. Write for the "Amplion Pedigree" and dealer's address.

THE AMPLION CORPORATION OF AMERICA

Executive Offices: Suite O, 280 Madison Ave., New York City

Canadian Distributors: Burndept of Canada, Ltd., Toronto

Associated Companies and Agents: Alfred Graham & Co., London, England, Patentes; Amplion Corporation of Canada, Limited, Toronto; Compagnie Francaise Amplion, Paris, France; Compagnie Continentale Amplion, Brussels, Belgium; Amalgamated Wireless (Australasia), Ltd., Sydney and Melbourne; British General Electric Company, Ltd., Johannesburg and Branches; Indian States and Eastern Agency, Bombay and Calcutta; C. J. Christie E. Hijo, Buenos Ayres; David Wallace & Co., Valparaiso; Mestre & Blatge, Rio de Janeiro; F. W. Hammond & Company, London and Tokio.

AMPLION

VOLNEY G. MATHISON'S

SUPER-MACHINE-WEAVE COILS

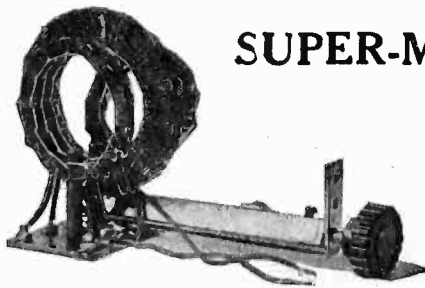

Heavy double green silk coils, machine wound and firmly sewed, on heavy nickel-plated direct panel mounting. For use with any condensers.

R-1—Adapted for use in the Browning-Drake circuit. Price, complete set, including antenna coil (not shown).....\$6.45

R-2—Adapted for use in the Roberts circuit. Price, complete set, including antenna coil (not shown).....\$6.95

Promptly shipped anywhere

RADIO OWNERS SERVICE COMPANY

660 Twelfth Street

Oakland, California

We cut, drill and engrave radio panels. Write for price sheet.

THE LOWLY LOW-LOSS

(Continued from Page 30)

laid away in the back alley ashcan, and presumably safe, as no ashcans have been moved off Post Street since January 2nd, 1903).

The mania for mechanical strength in inductance units, with the subsequent losses attendant, is not so crazy as the manufacturers appear. The average user does not initiate his inherently instilled sense of vision. For example: Assume that you have brought in POZ on the one tube Back Fire Superbox, and the after dinner speaker has just announced: "We will now discuss this matter of the scandal at Hollywood, U. S. A." Would you want a coil in the set that would fall apart after only the roof and a couple of upper floors had fallen on it? Of course not,—then by all means use the coil with the cast-iron wire and the pewter insulation. Never use air. Air can be had for nothing, and something for nothing always has strings attached. (View the old fashioned corset, at some museum,—or send self addressed and stamped envelope.)

Senor Alias Hassepeffer in the "Russian Radio Ticknicle" states: "For the actual elimination of losses, we must look toward the disintegration of the molecule. I have observed the energy turned loose when the ordinary fruit spoon is inserted in the common grapefruit. My American colleague advises that all America suffers from the ill effects of the kinetic energy so quickly released, and that they without exception wear goggles during the operation to protect the eyes. Never until I suggested it, has this energy been applied to radio. I have an infinitely clear vision of all America, governed by a time schedule, delving in the sounding depths of the grapefruit,—all in unison,—and liberating the stored up energy, heretofore in latent form. With the cumulative effect, this energy could be applied to radio as a negative resistance, and I believe the application would bear fruit in the right direction." Doctor Hassepeffer adds: "Very unfortunately, we have no long, slim, yellow fruit in Russia."

Nathan Salamander, the exponent of the electron counting machine, writes of experiments conducted toward the elimination of losses in the Marshall Islands in 1924. "The main losses," says Salamander, "are due to the lag and lead in the condenser plates. I find that the distribution of heating pads in the immediate vicinity of the plates, aids in getting the units warmed up to their work." This is substantiated, in the main, by the paper of Alberto Con Carne in Mexico City who, however, maintains that the heating effect of chile peppers is greatly advantageous, but obviating at the same time the labor of continually reheating the pads. (Regretfully enough, Salamander is at pres-

ent retired from the radio field and is living a secluded life at his old summer home at Matteawan, New York. The versatile contributions of his, made without stint or monetary consideration, are well known and admired in the radio world today.)

In the "Elektriker Blaster" is reviewed the assumptions of Francisco Tamale, first published in the "Journal of Male Cow Launching" in Bilbao last winter. "Inevitably," states Tamale, "there is a difference of opinion regarding the losses through eddy currents." Apparently the matter simmers down to a pregnant point, as he states further: "If Focault had devoted his time to raising potatoes, instead of following the aimless vagrancies of dissolute and shiftless whorls of current, there would be none today. But Focault advertised them and so created a market,—and subsequently they were foisted on the public. If they had been named jimie currents or willie currents, the eddies would necessarily be eliminated.

The most recent discovery in avoiding losses of all kinds, is to eliminate the radio set entirely. This experiment is being tried and watched with the greatest of interest throughout the entire Bay district and in Alameda. Important discoveries in this regard would be greatly welcomed by the collaborators.

Two Additions to Radio That Bring Complete Satisfaction

Once used they become essentials.

THE Instant-Change Radio Plug for connecting headset or loudspeaker fits all standard jacks, needs no tools, is fast, sure, positive. This is the pioneer and the leader in automatic plugs.

Model 506, two-inch Radio Panel Voltmeters, Ammeters and Milliammeters are invaluable for proper set operation, for insuring proper filament voltage, for lengthening the life of the tubes, for conserving batteries and giving the user greater distance, better tone, clarity and volume.

For further information write for the famous free booklet entitled "Weston Radio Instruments"

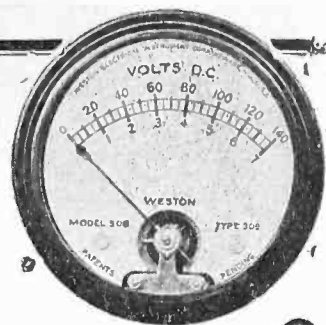

WESTON ELECTRICAL INSTRUMENT CORPORATION

156 Weston Avenue, Newark, N. J.

Pacific Coast Office: 682 Mission Street, San Francisco

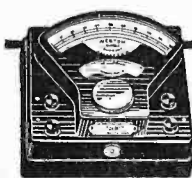

STANDARD THE WORLD OVER

WESTON

Pioneers since 1888

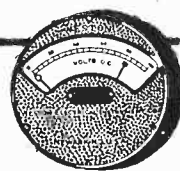

**now we'll
have clear
music**



MAGNATRONS in your set will give sweet purity of tone—clear and complete rendition of all the wealth of overtones. Music and speech come from the loudspeaker of the Magnatron equipped set with rich fidelity and generous volume, recreating in your home the actual performance itself, whether it be ten or a thousand miles away.

Magnatrons are the product of the oldest exclusive makers of vacuum tubes. That, in a large measure, explains their excellence. There's a Magnatron for every purpose. The DC-201A, the DC-199 [large or small base], the DC-120 [for super volume], and the Rex [for B Eliminators]. All list for only \$2.50 each.

Write for your FREE copy of "POT POURRI"—a snappy review of mirth and music to Department R. P.

CONNWEY ELECTRIC LABS.
Magnatron Building
Hoboken, N. J.

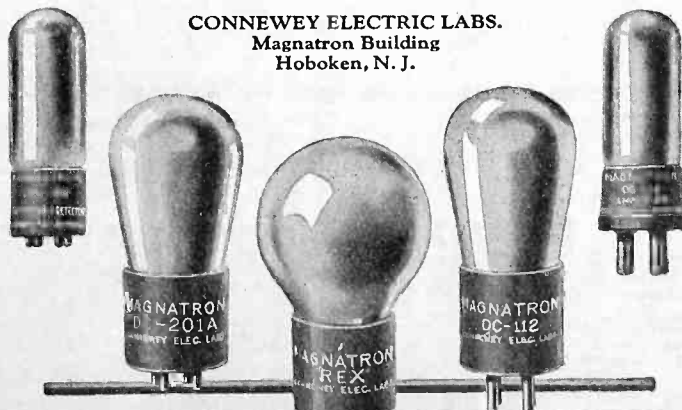

MAGNATRONS

Complete factory stock for Pacific Coast carried at Pacific Radio Labs., 256 So. Los Angeles St., Los Angeles, Cal.

Tell them that you saw it in RADIO

The REMO TRUMPET

CONCERT TYPE

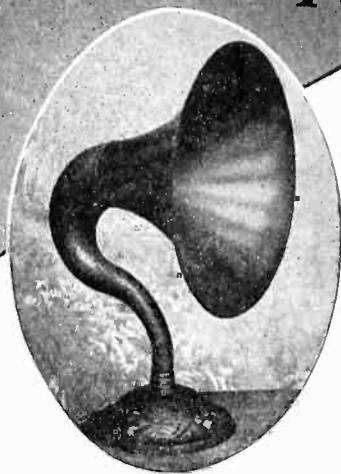

The Remo Trumpet
(Concert Type)
\$25.00

Dealer's Offer—both of these instruments will be sent to you on 10 days' free trial through your regular jobber. We are willing to do this so that you may hear them.

THE REMO CORP. MERIDEN, CONN.

Coast Representative:
FACTORY SALES AGENCIES CO.
Los Angeles San Francisco Seattle

Have You Heard It?

If Not, Read Offer Below!

Every radio fan will be surprised and delighted with this loudspeaker. It produces the high and low notes without distortion with true and clear reproduction. It also has plenty of volume. Acknowledges no superior at any price. Hand-somely finished in crystal black with grained mahogany bell and antique gold detail.

Price, \$25.00

The Remola Concert Cabinet

Produces the same beautiful tone as the Trumpet. A fine mahogany finished cabinet of just the right size.

Remola Concert Cabinet
\$25.00

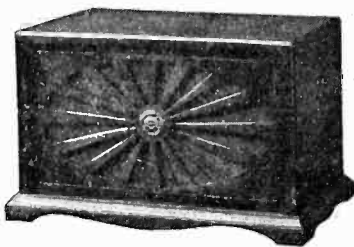

RADIO IN AUSTRALASIA

(Continued on Page 34)

valuation as binding on them. Evidently no law can compel the owners to sell, and a deadlock has been reached. Consequent upon the disagreement the local station has been closed down for over five weeks, and owners of crystal receivers in Wellington are much aggrieved over the situation as they have paid their license fees and are receiving nothing in return. The contract between the Government and the new company runs for five years. What make of transmitters the company has ordered has not been divulged, but rumor has it that there has been some difficulty in procuring them from abroad. The company is required to give a minimum service of twelve hours weekly from each station, and one of the promoters of the company has stated that the company will keep to the minimum! This has perturbed the radio "trade" for it does not seem anything like an adequate service, especially for demonstration purposes in their stores. However, things may not turn out as badly as some people anticipate. The New Zealand wavelengths are to be retained below 600 meters—a policy which finds unanimous favor.

In the meanwhile there are about 4,000 listeners, and they pay a license fee to the government of 30/ each. Trade is moving slowly in the meanwhile, but a marked improvement is certain when the two new stations get on the air. Scores of listeners look to Australia for their entertainment nightly, now that the stations over there are coming in so well. The distance between the nearest radiocast station and the heart of New Zealand is about 1,500 miles, and when static is less active some splendid reception is available for owners of even two-tube sets in New Zealand. Owing to the difference in time between the two countries, when the Sydney stations commence their evening programs at 8 o'clock it is 9:30 o'clock at night in New Zealand, and 2 o'clock in the morning, Pacific Coast Standard time.

The existing New Zealand stations are located at Auckland, Gisborne, Christchurch and Dunedin, and the last-mentioned, with an output of 500 watts, can be heard pretty well throughout New Zealand except when static takes a hand, and spoils reception from upwards of 150 miles.

A bottle of ammonia should always be kept near the storage battery table to neutralize the action of the acid.

A good center punch for light work can be made by grinding a broken off machine tap to a suitable point.

A short piece of rubber tubing, suitable for "sleeving" can be made up from a piece of lamp cord drawing the stranded wires until the inside is left in a tubular form.

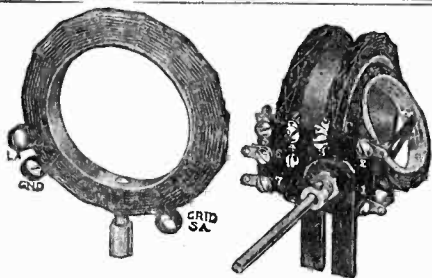

Coil Set No. 24 for Browning-Drake Circuit

SICKLES DIAMOND WEAVE COILS

For Browning-Drake
Roberts, Craig and
Hoyt Circuits
(Patented Aug. 21, 1923)

Sickles Coils for the famous Browning-Drake Circuit are the latest Sickles achievement in efficient design for a particular use. They are priced at \$7.50 a set.

The New No. 18A Coils for any Roberts Circuit are absolutely standard equipment. They are priced at \$8.00 per set.

Coil Set No. 20, at \$4.50, is for use specifically with the new Reflex Receiver designed by Albert G. Craig using the Sodian detector.

Coils for the Hoyt Circuit at \$10.00 a set for the Knockout Reflex Circuit at \$4.00 a pair, and the Tuned Radio Frequency coils at \$2.00 each are other standard Sickles Coils. We manufacture also for manufacturers' special requirements.

Send for descriptive catalog

The F. W. Sickles Co.
138 Union St. Springfield, Mass.

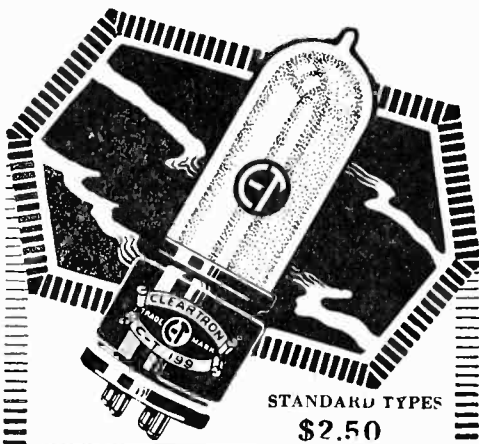

STANDARD TYPES
\$2.50

CLEARTRON

GUARANTEED RADIO TUBES

Being unequalled for their long life and easy drain on batteries, Cleartrons are the most economical tubes you can buy. And—remember this, we guarantee perfect service or instant replacement. Buy quality—Cleartrons.

At all reliable dealers
Write for free six page tube folder.
CT-101A—A Hi-Mu tube for Resistance-Coupled Amplifiers \$3.00

CLEARTRON VACUUM TUBE CO.
28 West 44th Street New York City

Factories:
West New York, N. J., Birmingham, Eng.

FOR BETTER RECEPTION

ARE YOU A SUBSCRIBER?

SEND \$1.00 FOR A TRIAL SUBSCRIPTION TO "RADIO" FOR 6 MONTHS

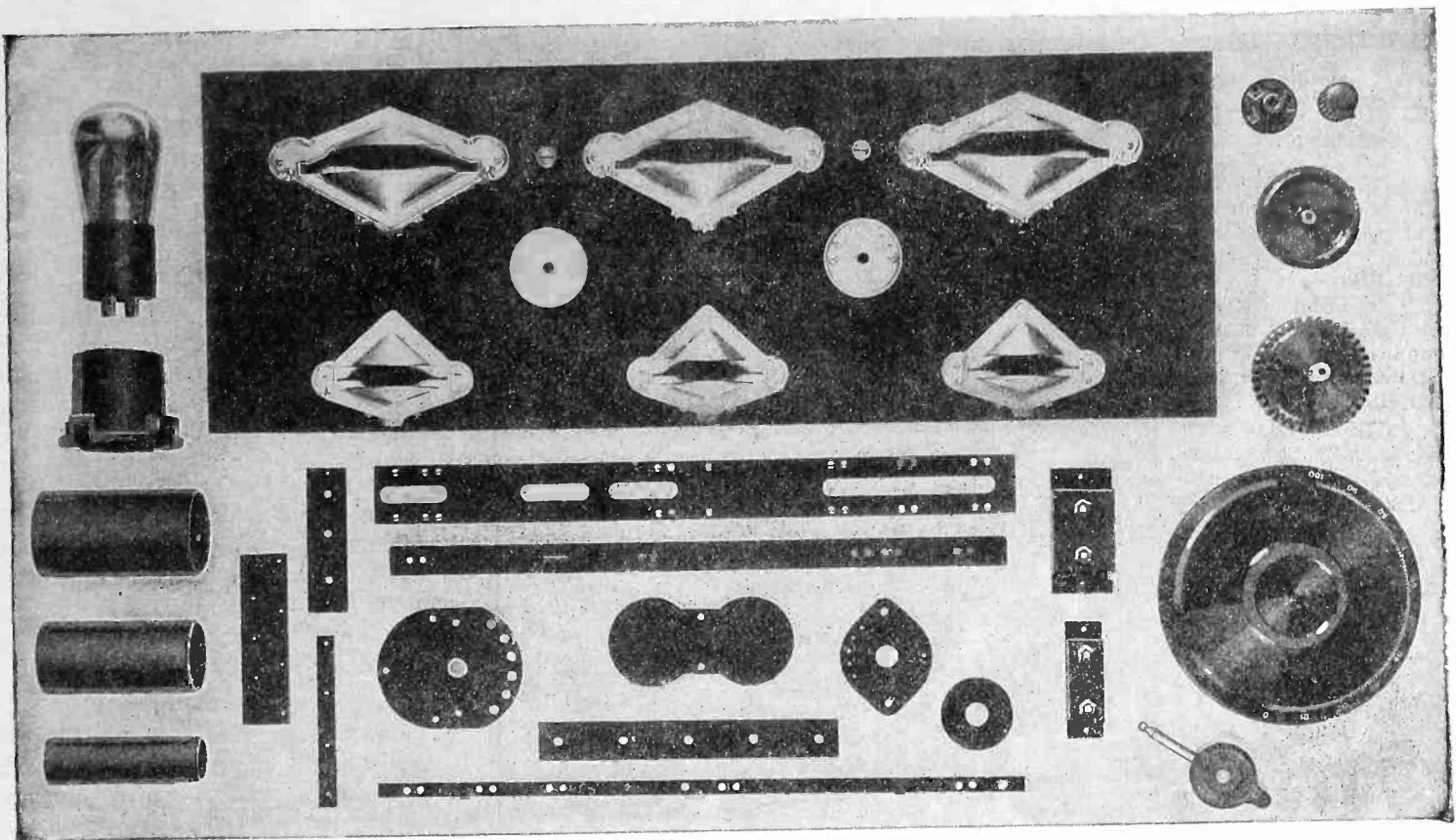

Imagine a Radio Set stripped of these parts

What a useless collection of wood, wire and metal it would be. Realizing that the parts and accessories shown here are wholly or partly of Bakelite, gives you a vivid picture of its importance to Radio.

Today Bakelite is used in a greater variety of radio parts than ever before---and the number grows constantly. This dominance of Bakelite in radio

reflects the experience and the opinions of radio manufacturers, great and small.

Radio set and parts manufacturers have every facility for testing all insulation materials and over 95% have standardized on Bakelite. This indicates how really important it is for you to make sure that the set or parts that you buy are Bakelite insulated.

Write for Booklet 30

BAKELITE CORPORATION

247 Park Avenue, New York, N. Y.

Chicago Office: 636 West 22nd St.

Western Representative:

ELECTRICAL SPECIALTY CO.

443 S. San Pedro St.
Los Angeles

75 Fremont Street
San Francisco

1041 Sixth Avenue So.
Seattle

Bakelite is an exclusive trade mark and can be used only on products made from materials manufactured by the Bakelite Corporation. It is the only material which may bear this famous mark of excellence.

BAKELITE

REG. U.S. PAT. OFF.

BAKELITE
is the registered trade mark for the phenol resin product manufactured under patents owned by the Bakelite Corporation.

THE MATERIAL OF A THOUSAND USES

Tell them that you saw it in RADIO

it's in the **TUBE**

YOUR receiving set can be no better than its tubes. CECO Tubes give maximum results in clarity of tone, rich volume and long life.

Our charted tests (results confirmed by laboratories of national reputation), PROVE CECO TUBES SUPERIORITY — as detectors, as amplifiers.

Buy CECO Tubes whether your set takes one tube or eight.

Now ready! CECO Tubes with new type long PRONG BASES. Also, power amplifier tubes, E (Dry Cell Type), F (Storage Battery), for last stage of Audio Frequency. Ask your radio dealer.

C. E. MFG. CO., Inc.
702 Eddy St., Providence, R. I.

CECO
TUBES

	"A"	"B"	"C"
Filament Volts	5.0	3.0	3.0
Filament Current	0.25	.06	.06
Plate Voltage	20 to 120	20 to 80	20 to 80



SOME EUROPEAN RADIO NOTES

From H. DE A. DONISTHORPE
Spain Follows America With
Wireless Fog Signal

Spain is the latest country to follow America's example and has erected a wireless fog signal after the type that the Bureau of Lighthouses has installed all around the American coast. This new aid to navigation has been erected at Cape Silleiro on the wild Galician coast. The wavelength that has been adopted for this service is 1000 meters and the station has a range of 30 miles. The distinctive signal to be sent out are the two letters OR which will be transmitted every five minutes during foggy weather.

Third Anniversary of the British Broadcasting

The month of November celebrated the third anniversary of the British Broadcasting Company, which company has consequently been offering during that month special programs in honor of the occasion.

Stereoscopic Broadcasting

In order to eliminate that trying echo effect which is noticeable when broadcasts are given of theatrical productions from a stage, a new arrangement was recently tried out from one of the London theaters with considerable success. This experiment is likely to be embodied in further broadcasts of this nature.

Chaliapine Broadcasts for the First Time

During November, just prior to his departure from England for America, Chaliapine for the first time faced the microphone and delighted his audiences with some lovely selections. For this broadcasting it is understood that the famous singer was paid at the rate of \$5,000 per hour.

The interference that may be caused by a radiating regenerative receiver is well illustrated by the fact that two such sets are regularly used with a telegraph key to maintain communication between two Alaskan stations twenty miles apart.

FILTER TRANSFORMERS

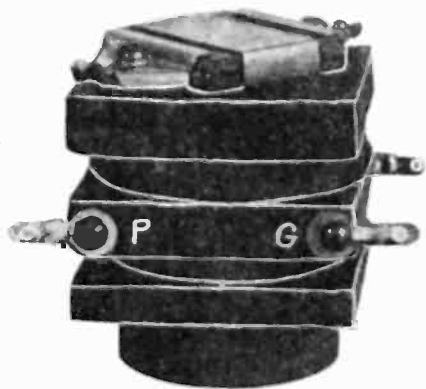

Northern Electric Type Filter Coils adjusted to any specified frequency between 25 and 60 kilocycles, complete with calibrated condenser

ONLY \$5.00

Throw away that inefficient, unknown quantity in your set and replace it with a filter which won't distort.

ARMY SALES COMPANY

1650 Jackson Street

San Francisco, Calif.



RADIO IN RECORDING EARTHQUAKES

(Continued from Page 35)

transformers amplifies the audio frequency signal and the output of the amplifier is connected through another transformer to a rectifier tube, in the grid of which is placed a large C battery, which keeps the plate current of the rectifier tube at zero when no signal is being received. In the plate circuit of the rectifier, which is an ordinary UV-201-A tube, is a sensitive relay having a rather high resistance, about 2000 ohms, and which operates positively on a current of only 2 milliamperes.

When a time signal is received in the tuner and is amplified in the audio

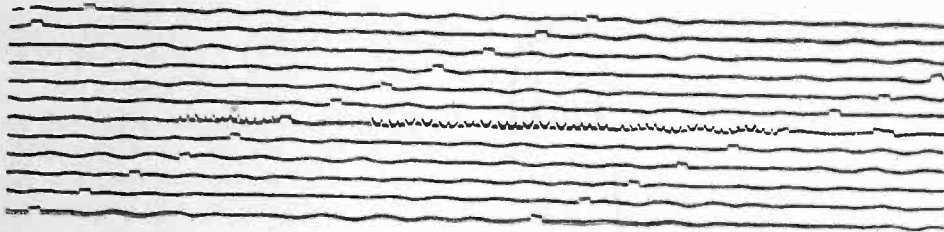

Fig. 3. Record of Time Signals on Seismograph Chart.

stages, the impulses cause direct current to flow in the plate circuit of the rectifier tube, and the armature of the relay is made to close another circuit which is connected to the seismograph. The audio frequency currents in the plate of the rectifier tube are by-passed to the filament by means of a 1 mfd. condenser, so that only direct current is permitted to flow through the relay. As the dots denoting the second intervals are received from the transmitting station, the relay closes the seismograph circuit with only a few thousandths of a second of lag, and a small amount of direct current which passes through a coil associated with the seismograph causes the mirror to deflect slightly for an instant.

The result of the action of the relay is plainly seen in Fig. 3, each impulse appearing as a break in the continuous wavy line. The final dash which occurs on the hour is shown at the extreme right of the picture, on the 5th line from the bottom, and it is from the beginning of this dash that the correction for the chronometer attached to the seismograph is computed. As can be seen from the picture, in this particular instance, the clock was about 10 seconds fast, and earthquake records which appear on that par-

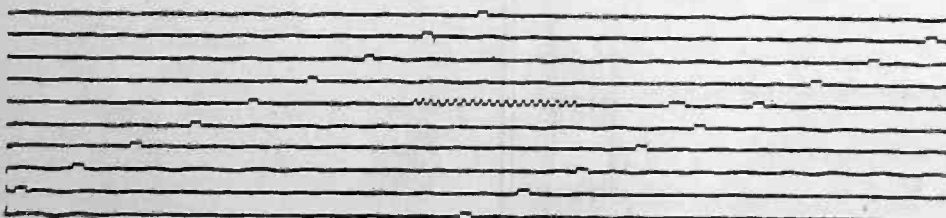

Fig. 4. Hand Operated Time Signal Record.

ticular chart can be accurately estimated as to the time of occurrence.

With only the regenerative detector to pick up the time signals, the approximate range of the radio receiver is only 1000 miles, with positive action of the relay, and hence in order to obtain a record of the signals from Annapolis, which is 3000 miles away, the relay is operated by hand, by a trained operator, who listens to the time signals with the headphones, and presses a telegraph key at each dot. This is of course a less accurate method, but it is interesting to note in Fig. 4 that the hand-operated signals shown thereon are remarkably uniform, and are well within the requirements of the accuracy of the seismograph, which is about 1/10th second.

A long wave amplifier tuned to 17½ kilocycles, which is the transmitting frequency of NSS, is being constructed, and it is hoped that the addition of the amplifier ahead of the present detector circuit will sufficiently augment the signal strength to permit operation of the relay from NSS without hand operation.

Acoustic Expert Improves Loudspeaker

By applying somewhat the same principles as he used to improve the tone quality of a violin, Dr. Herman Fisher, a Russian scientist, has developed a unique diaphragm which is claimed to produce exceptional loudspeaker tone quality. In the case of violin he found that the greatest thickness in the wood of a Stradivarius was not in the geometrical center but directly under the foot of the sounding post rests. Likewise he has constructed a diaphragm that is thicker at one portion of its surface than at the other. This is done by welding two separate diaphragms together.

Upon the placing of this center of metallic depends the tone reproduction vibrations of the loudspeaker, a correct placement giving a true natural pitch to both music and voice. This principle has been applied to the new Tower loudspeakers which are claimed to give a roundness of tone to the low notes of an organ or bass drum and a lack of distortion to the high notes of a cornet or violin not hitherto attainable by other forms of diaphragms.

Build the Set That Holds 4 World's Records



The receiver that brought in stations 6,000 to 8,000 miles distant with loud speaker volume night after night. All records fully verified.

Holds World's Records For

- (1) Longest distance ever received on a loop aerial — 8,375 miles.
- (2) Most consistent reception of stations 6,000 to 8,000 miles distant — 117 programs in three months.
- (3) Brought in 6 different stations in 2¼ hours — all over 6,000 miles.

PRICE:

Complete Set of Parts.....\$89.00
(Includes all parts necessary to make an exact duplicate of this wonderful receiver, together with book of instructions and complete blue prints.)

Story of development and proofs of records sent on receipt of stamped and addressed envelope.

Scott Radio Laboratories
37 South Dearborn Street, Chicago
Dealers and Set Builders,
Write for Discounts

Morrison

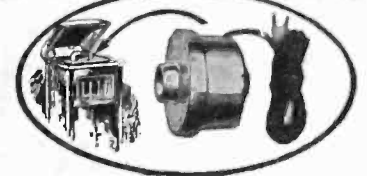

Loud Speaker

Matchless Reproduction

with the

MOCKING BIRD UNIT

and Your Phonograph

For complete enjoyment of all that is best in radio, for purity of tone and plenty of volume on distant stations, be sure your set reproduces through a Morrison Unit—a standard for four years. Attach the Mocking Bird Unit to the tone arm of your phonograph (fits all popular makes) and you have the finest possible means of reproducing radio reception.

Mocking Bird Cabinet
\$30.00

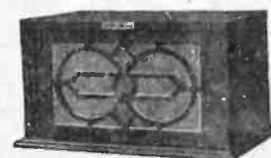

DEALERS
Be sure your holiday orders are in early. Remember the rush for Morrison Loud Speakers will surpass all previous years.
SET MFG'RS.
We are able to supply units in quantity orders at attractive prices.

Deliveries are assured with acceptance of order.
To own a Mocking Bird Cabinet is to possess the peer of all loud speakers. The Morrison Unit is instantly adjustable. You will be proud of your Mocking Bird—not only its performance, but the artistry of its design and workmanship.
If your dealer cannot supply you, send money order or check to factory. If you prefer, we will ship C.O.D. Every Unit sold on money back guarantee.

Morrison Laboratories

325 E. Jefferson Avenue

Detroit, Mich.

DURHAM

Variable Leaks

Make Good Tubes Better



Standard Type

For any set. Snap in place of present fixed leaks. Adjustable in line with tube makers' instructions.

75c

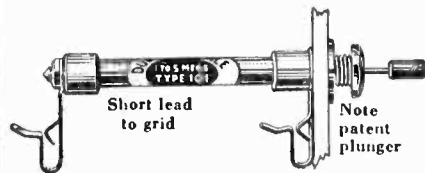

New Panel Mount

Accurate control of detector or audio at your finger tips brings better results.

\$1.00

There's a DURHAM for Every Need

- No. 100—1,000 to 100,000 ohms (audio).
- No. 101—0.1 to 5 megohms (for UV-200 and WD-12).
- No. 201A to 5 megohms (for UV-199 or 201A tubes).

DURHAM & CO., Inc.
1936 Market St., Philadelphia



No Back Panel Fussing

Genuine Bakelite Throughout

DeJUR RHEOSTATS

ONE HOLE MOUNT

The one hole mount, one of the many exclusive features of the DeJur, makes it the easiest of all rheostats to mount, and when mounted it sets fixed and rigid. No screws to get loose, no back panel fussing. Compare the DeJur. You will readily recognize its difference and superiority.

Sold by all dealers

Manufacturers—Write for sample and prices

DeJUR

PRODUCTS CO.

LAFAYETTE & BROOMES STS
NEW YORK



LATEST "COAST TO COAST" FULLY GUARANTEED RADIO'S-10 DAYS FREE TRIAL

SAVE 1/3 TO 1/2

Users everywhere report Miraco Radios get programs coast to coast on loud speaker; outperform sets three times as costly. Many hear foreign countries. Radio's most amazing value in unconditionally guaranteed, factory-built long distance sets—let testimony of users convince you.



MIRACO RADIO GETS 'EM COAST TO COAST

Powerful New Multi-tube Miraco gets long distance on loud speaker. Set, ONLY \$27.35 retail

FREE! Literature on latest improved 1 to 6 tube models, new low prices, testimony of users and SPECIAL OFFER. Write: **MIDWEST RADIO CORP'N** Pioneer Builders of Sets 414 W. E. 8th St. Cincinnati, O.

AGENT USERS WANTED Write for discounts.

To-day -in every good set!



"I'm a MASTER OPERATOR"

AMPERITE never distinguishes between a novice and an experienced operator for the wonderful clarity and full, rich tones it makes possible. Just pull the switch and each individual tube does its utmost to outdo the other tubes. The "Self-Adjusting" rheostat that takes the guess out of tube control. Used in all popular construction sets. Price, \$1.10.

There is an AMPERITE for every tube

Write for free hook-ups

Radiall Company

Dept. R-1, 50 Franklin St., N. Y. City

AMPERITE

REG. U.S. PAT. OFF.

The "SELF-ADJUSTING" Rheostat

CARTER New "FLAT" Plug

(Pat. Pend.)



FULL SIZE 75c

This plug was the sensation of the New York and Chicago Radio Shows. Again Carter originality scored a success. Fits flush against panel, cords hang down. Instantly connected or disconnected. See one at your dealer's today.

Any dealer can supply

Coast Distributors: **A. S. LINDSTROM & COMPANY**
274 Brannan Street, San Francisco, California

Branch Offices at
Los Angeles, Portland, Seattle, Salt Lake City

IN CANADA: Carter Radio Co., Limited, Toronto

Carter Radio Co.

390 S. RAGINE AVENUE
CHICAGO, ILL. U.S.A.

RADIOCAST WEEKLY

Sixty-four Pages of Programs, Photos, Humor, Musical Reviews, Schedules, Tables, Editorials, Etc.

5c Per Radiocast Weekly

Copy 433 Pacific Bldg., SAN FRANCISCO

CALLS HEARD

(Continued from Page 44)

By 9MM., Converse, Indiana

6aak, 6abg, 6abs, 6acp, 6adw, 6ael, 6afl, 6alo, 6ajj, 6ajm, 6ake, 6akm, 6akt, 6aku, 6akx, 6akz, 6am, 6ame, 6ano, 6anp, 6aqf, 6ase, 6awa, 6bam, 6bau, 6bav, 6bbv, 6bde, 6bek, 6bgb, 6bgo, 6bgv, 6bir, 6bis, 6bka, 6bjd, 6bkb, 6bmw, 6bq, 6bsc, 6bu, 6cah, 6cbj, 6cco, 6cdy, 6cej, 6cfe, 6cgo, 6cgw, 6chs, 6chy, 6ckz, 6clp, 6cmq, 6cnd, 6cns, 6cou, 6cpl, 6cqa, 6crf, 6crs, 6csa, 6css, 6csw, 6ct, 6cto, 6cub, 6cuc, 6cvq, 6cwr, 6cwl, 6dag, 6dah, 6dal, 6dam, 6dao, 6daq, 6das, 6dat, 6dbh, 6dcf, 6dh, 6dn, 6ds, 6ec, 6ek, 6fa, 6gu, 6gx, 6hm, 6hw, 6jl, 6jp, 6ja, 6kd, 6lh, 6ml, 6nw, 6oa, 6ol, 6rn, 6rw, 6sb, 6sl, 6sk, 6tl, 6uf, 6vp, 6vr, 6vs, 6wp, 6yd, 7aek, 7afo, 7alf, 7alk, 7av, 7ay, 7ek, 7eo, 7fb, 7gs, 7gy, 7it, 7kl, 7lq, 7ly, 7nx, 7ps, 7rl, 7uj, 7uv, 7ya, 7ajq, 7xaf. Canada: 1am, 1ar, 1el, 4aa, 4gt, 3gs, 5ef, 5go, 5hp. Alaska: 7kn. England: 2nm, 2sz. France: 8fz. South Africa: A4Z. Brazil: 1ab. Cuba: 2mk, 2jt. Bermuda: ber. Porto Rico: 4sa, 4kt, 4ur. Hawaii: 6aff, 6ajl, 6buc, 6np, 6xl. Mexico: 1a, 1aa, 1af, 1b, 1j, 1k, 1x, 9a. New Zealand: 1ao, 2ac, 2ae, 2ap, 4aa, 4ac, 4ag, 4ak, 4ar, 2xa, 1ax, 2lv, 4as, Z6BV?. Australia: 2bm, 2cm, 2rj, 2cs, 2tm, 2bb, 2ds, 2jw, 2yh, 2yl, 3ef, 3ak, 3bd, 3bm, 3bq, 3bb, 3tm, 3xo, 5bg, 6ag, 4iv. Samoa: 6zac, 6nu. India: 6ne. Commercial: fw, vlv, wir, wiz, wqo, ipz, pox, poy, poz, kfu. Miscellaneous: Qra's wanted 2re, 2bg, pit, d15, np, pm.

By 6BUH, Salt Lake City, Utah

1aac, 1acl, 1amf, 1axa, 1air, 1aao, 1are, 1ahg, 1acg, 1ang, 1arh, 1ay, 1ajg, 1ajo, 1bgz, 1bzb, 1ch, 1cmf, 1qi, 1yb, 1sj, 1uw, 1qm, 1xu, 2api, 2aiu, 2afx, 2agb, 2aky, 2bl, 2bw, 2bbx, 2bnm, 2bpb, 2cxl, 2cty, 2ctq, 2cyu, 2dh, 2dx, 2nf, 2xaf, 2kr, 2kg, 2ha, 2vt, 2mf, 2aao, 3abn, 3awy, 3afq, 3bz, 3cel, 3cdv, 3cdk, 3id, 3om, 3vx, 3ot, 3hg, 3lr, 4aa, 4aae, 4ah, 4aj, 4av, 4cu, 4dk, 4fl, 4fr, 4fl, 4hr, 4jr, 4js, 4kw, 4oa, 4ok, 4qc, 4ab, 4uk, 5ato, 5bg, 5ls, 5ov, 5ph, 5sd, 8aab, 8avo, 8ago, 8aly, 8avl, 8aub, 8afm, 8ajn, 8axn, 8acf, 8ay, 8ayy, 8bsc, 8bho, 8bgn, 8bfg, 8bce, 8bt, 8by, 8bcv, 8bf, 8bpl, 8bvt, 8cau, 8cqh, 8ckm, 8cuz, 8daa, 8dal, 8don, 8dnf, 8dno, 8dkr, 8eb, 8zm, 8fq, 8zu, 8se, 8yo, 8ze, 8jq, 8gz, 8wo, 8jj, 8qt, 8uk, 8vk, 8tw, 8pl, 8tx, 8sk. Commercial: wvz, ven, fw, wqo, waw, kfu, kel, fnk, wiz, xda, wqn, vfzz, fnd, zkn, wir. Foreign: a2yl, a5au, a3bd, alaa, c4gt, c4ax, cikg, c2tm, c4aa, c5go, c3oh, ch2d, f8si, hid, mlaa, mlb, jb, lg, lx, m9a, nism, pilau, rcb8, rbz, rlaf, z4au, z3bm, z4ar, z2ae, z4al. Samoa: 6zac. Porto Rico: 4ol.

By 9DPX, St. Paul, Minnesota, during Oct.

Australia: 2bb, 2bc, (2bk), 2cm, (2cs), (2ds), 2dy, 2gq, 2hs, 2ij, 2jw, (2io), (2rf), (2aw), 2tm, (2ul), 2yh, (2yi), (3ad), (3ak), (3ap), (3rd), (3bm), 3bu, 3cb, (3ef), 3jr, (3kb), 3lm, 3qh, 3sl, (3tm), 3xo, (3yx), (5ah), (5bg), (5da), (5kn), 6ag, (7dx), (7jb), (7om), (7pf), 8ab, (9dr). Bermuda: (beBER). Brazil: 1ab, 1ia. Chile: 2id, 9tc. Hawaii: 6oa, (6ajl), 6bol, (6buc), (fx-1). Mexico: 1aa, 1af, 1b, 1j, 1k, 1n, 1x, 9a. Philippine Islands: 1hr. Porto Rico: 4jv, (4kt), 4rl, 4sa. Cuba: 2jt, 2mk. Argentina: af-1, ba-1, af-2, fb-6, fc-6, bg-8, cb-8, dm-9. New Zealand: (1ao), (1ax), (2ac), 2ae, 2bl, (2br), (2xa), (3am), (3ao), 4aa, (4ag), (4ak), 4al, 4ar, (4as), (4av). Others: ane, gdvb, kfu, nlr, nism, (nisp), nlsr, (npm), (npu), nqg-1, (nqg-2), (nrll), nsf, (numm), (nve), vmg, wap, wnp, wyd, (wyh), (xa-1), (xa-2), xda.

By 9APY, 3337 Oak Park Ave., Berwyn, Ill.

1aae, 1aal, 1aao, 1bqq, 1cmf, 1kl, 1pl, (1uu), 2aaw, 2adk, 2aep, 2aes, 2ajw, (2akv), (2amf), 2bbx, 2bck, 2bkr, 2cbg, 2cxl, (2ll), 2lu, 2ra, (3aal), (3afw), 3ahj, 3aho, 3aso, 3bel, 3buv, (3cch), 3ckp, (3fl), 3gk, (3na), 3tr, 3ur, 3zm, 4bk, 4kk, 4ml, 4nr, 4vo, 4wp, (5abl), 5apq, 5fs, 5hn, 5wk, 5zal, 6aom, 6aaz, 6bcs, 6bkm, 6ctx, 6dxh, 7dg, 7dm, 7sb, (7pp), (8ahc), 8bdj, 8cme, 8cv, (8gi). Canada: c3fu, (c3oh). Misc.: keo, napg, wir, wiz, wqo. Qrk? Card for card here too.

9APY—3337 Oak Park Ave., Berwyn, Ill.

1adw, 1amm, 1aof, 1bqd, 1bue, 1cmx, 1db, (1kj), 2adk, 2alb, (2akv), 2amj, 2ana, 2bum, (2cds), 2cep, 2ff, 2gp, 2mt, (3afw), 3al, 3bmt, (3bq), 3cfn, 3cov, (3gt), (3pt), 3yo, 4bp, 4ccb, (4fr), (4vo), (5aay), (5abi), (5ada), 5apq, 5apl, 5aqx, 5ary, 5ata, 5atz, 5awf, 5fh, 5fq, 5ju, (5qz), 5rg, 5sg, 5tt, 6cae, 6cco, (6cmg), 6wt, 6xbm, 7dd, 7dm, 7pp, (8ahc), 8brd, (8bvj), (8cfv), (8gl), 8nn. Canadians: (c-3ka). Miscellaneous: af2, nkf, ovr, srd, wir, wiz, wqo. Cards waiting. QRK?

(Continued on Page 78)

The Reason
 THE TUBE WITH A SENSIBLE GUARANTEE



**Quality!
 Performance
 Dependability**

are the factors which made Supertron the foremost Tube in America !!!

The Public buy and enjoy Supertrons because they are assured of satisfaction by a serial numbered guarantee on each tube for their protection—at their own price; the public demand price—two dollars.

The best dealers sell Supertrons because they give the most satisfaction; the best profit and a permanent good will.

The jobbers who practice their purposes sincerely carry Supertrons to serve their dealers better because Supertron facts are beyond dispute.

Backed by a rigid policy; substantial organization and clean merchandising.

All Types \$2.00 Each
 Canada \$2.75

Pacific Coast Office: Pacific State Commercial Co., 3208 Glendale Blvd.

- | | | | | |
|--------------|------------|-------------|-------------|-------------|
| Atlanta | Pittsburgh | Minneapolis | Buffalo | Los Angeles |
| Dallas | Chicago | Kansas City | Boston | Portland |
| Philadelphia | Detroit | Denver | Omaha, Neb. | Toledo |
| | | | | St. Louis |

SUPERTRON MFG. CO., INC., HOBOKEN, N. J.

Export Department, 220 Broadway, New York



SUPERTRON

A SERIAL NUMBER GUARANTEE



Oh boy!
KESTER
 Rosin Core
Radio SOLDER
 Sure is Safe and Simple

Approved by
 Radio Engineers
 A Genuine Solder
 CHICAGO SOLDER COMPANY
 4254 Wrightwood Ave., Chicago, U. S. A.

Originators and
 World's Largest Manufacturers of
 Self-Flowing Solder
 YOUR DEALER
 CAN SUPPLY YOU

MARWOL



**Beautiful—
 In Appearance!
 and Performance!**

Before you select any receiver --- see the MARWOL Line of five tube tuned radio frequency and six tube radio coupled amplification receivers. It embodies 13 different models ranging from the five tube Jewel at \$39.50 to the Console Grand, illustrated above, at \$130.

In beauty of appearance, high quality and superior performance, the MARWOL Line is unsurpassed---regardless of price.

Every MARWOL Receiver carries the iron-clad MARWOL guarantee. And the trade is assured of prompt deliveries from our two big factories of a line that is solidly backed and one on which there is no summer dumping.

Manufactured and Guaranteed by
Marwol Radio Corp.
 546-548 BROADWAY, NEW YORK CITY

- Distributed to the trade by
- | | |
|------------------------------|------------------------|
| In California: | In Oregon, Washington: |
| MARSHANK SALES Co. | C. E. CAY |
| 926 Insurance Exchange Bldg. | 166 Lowndale Street |
| Los Angeles, Calif. | Portland, Oregon |
| In Idaho: | |
| R. T. CARR | |
| 906 Sprague St. | |
| Spokane, Washington | |

Tell them that you saw it in RADIO

(Continued from Page 76)

By Albert E. Scarlett, Jr., 23 Cooley Place, Mount Vernon, N. Y.

U. S. A.: 6ac, 6ajm, 6bon, 6cig, 6css, 6dal, 6dn, 6fa, 6ji, 6rn, 6wt, npg, nqg. Argentina: af2, bal, cb8. Australia: 2bk, 2cm, 2ds, 2tm, 2yl, 3ad, 3bd, 3bm, 3bk, 3kb, 3tp, 3xo, 5ah, 5kn, 6ag, 9dr. Bermuda: ber. Brazil: 1ac, 1la, 1af. Cuba: naw, nisp, nist, nve. England: 2kf, 2nm, 2sz, 5dh, 5lf, 6lj, 6tm. France: 8dp, 8gi, 8yor, fw. Germany: aga. Haiti: nisp, nisir, nve. Hawaii: 6ajl, 6buc, npm. Holland: pb3, pemm. Italy: 1bd, ntt. Java, Dutch East Indies: ane. Labrador: wap, wnp. Mexico: 1aa, 9a, xda. New Zealand: 1ao, 2ac, 2ae, 3am, 4ag, 4ak, 4al, 4ar, 4as, 4av. Panama: 99x. Pacific Ocean: nappg, f8z. Porto Rico: 4rl. Samoa: 6zac. South Africa: oa4z. Switzerland: 9ak. Tasmania: 7jb. Ship off Africa: sgc. All heard on 93 foot indoor antenna and 1 audio.

By H. C. C. McCabe, 71 Holloway Road, Wellington, New Zealand, 40 Meters.

United States: 1aae, 1acl, 1aep, 1ahg, 1apu, 1alw, 1are, 1axa, 1azd, 1cmf, 1cmp, 1cmx, 1cal, 1caw, 1er, 1lm, 1ka, 1ch, 1rr, 1te, 1za, 1vc, 1xu, 1yb, 1uw, 1pl, 1ao, 1qm, 1ahl, 1xm, 1axn, 1bhm, 1bfl, 1aiu, 1sl, 1bg, 1awi, 1hn, 1bay, 1ccx, 1aff, 2cxl, 2cvj, 2cqz, 2cvu, 2cig, 1cty, 2cyw, 2ahm, 2ate, 2aky, 2agq, 2blm, 2brb, 2beo, 2xaf, 2kr, 2mm, 2kg, 2gk, 2wc, 2xg, (phone), 2zy, 2awf, 2ahk, 2aim, 2cpa, 2bm, 2gy, 2hh, 2sz, 3ckj, 3bg, 3hg, 3ld, 3vx, 3py, 3zm, 3xav, 3bct, 4sl, 4io, 4rm, 4iv, 4fl, 4tv, 4oa, 4cu, 4xe, 4jr, 4aah, 4rr, 4do, 4uz, 4kn, 5aid, 5amk, 5asd, 5akl, 5atv, 5atx, 5adz, 5amw, 5ame, 5atg, 5akz, 5asv, 5ew, 5ft, 5hy, 5jf, 5lg, 5ls, 5nq, 5qw, 5ad, 5va, 5oq, 5nw, 5ph, 5rg, 5uk, 5zal, 5lf, 5agn, 5kw, 5he, 5aap, 6ac, 6ea, 6oa, 6qd, 6dn, 6ct, 6ut, 6ml, 6lj, 6uf, 6rn, 6jp, 6js, 6vr, 6sb, 6oi, 6nw, 6hw, 6vc, 6lh, 6ji, 6ws, 6wt, 6rw, 6qu, 6yd, 6bq, 6hc, 6rm, 6nx, 6abg, 6akx, 6aak, 6adw, 6ahp, 6ajm, 6amo, 6ake, 6awt, 6asm, 6akm, 6ano, 6aut, 6bjd, 6bur, 6bde, 6bon, 6beb, 6bvq, 6bt, 6bjv, 6bav, 6bip, 6bgb, 6bbv, 6bsf, 6bir, 6bse, 6bvq, 6bhx, 6baa, 6bgc, 6bmw, 6cah, 6csw, 6cqa, 6cto, 6cnh, 6cuc, 6cnm, 6cmq, 6css, 6chl, 6chy, 6cgo, 6cev, 6cco, 6cdy, 6cfe, 6cpl, 6cnd, 6cur, 6cfl, 6cqe, 6dax, 6dal, 6dam, 6dat, 6dag, 6das, 6dao, 6dbe, 6zac, 6avj, 6daq, 6ase, 6bhx, 6cbj, 6afh, 6ank, 6alv, 6btm, 6che, 6eb, 6ec, 6ew, 6gk, 6ih, 6kb, 6li, 6ms, 6qi, 6vt, 6bny, 7ay, 7de, 7av, 7cs, 7ek, 7fb, 7lf, 7gb, 7lq, 7rl, 7oz, 7it, 7gs, 7uv, 7uj, 7afo, 7aly, 7aek, 7ao, 7ya, 8er, 8eq, 8es, 8ex, 8jq, 8gz, 8ry, 8rv, 8se, 8pl, 8tx, 8zu, 8pk, 8ada, 8adg, 8ago, 8agq, 8alg, 8ayy, 8bau, 8bce, 8bkq, 8buk, 8bnh, 8byn, 8bgn, 8bpl, 8cyl, 8ced, 8cau, 8ceu, 8ces, 8dfk, 8jl, 8up, 8fa, 8bq, 8abm, 8aly, 8ben, 8cwk, 8djp, 9ic, 9wo, 9zt, 9ph, 9tj, 9xp, 9xn, 9la, 9uq, 9ek, 9kb, 9ua, 9adr, 9aey, 9ado, 9aot, 9ave, 9adk, 9bwb, 9bbh, 9bcn, 9bv, 9bml, 9bwg, 9bez, 9bmx, 9brk, 9btz, 9cej, 9cvj, 9cfy, 9che, 9clr, 9cld, 9dng, 9drd, 9dpx, 9dnx, 9ddc, 9dbb, 9dms, 9dmj, 9dqr, 9dqu, 9deq, 9dac, 9eel, 9ejl, 9eky, 9eez, 9ecc, 9ejy, 9efs, 9eht, 9elz, 9cvn, 9nk, 9ark, 9eas, 9se, 9bpb, 9hp, 9afx, 9zk, 9dqm, 9xl, 9dvi, 9nl, 9cgu, 9ee, 9dct, 9dpl, 9bbf, 9bcd, 9ebx, 9dvl, 9mn, 9cj, 9daj, 9cur, 9ctr. Canadian: 2bg, 2fo, 3xl, 3aa, 3kp, 4cr, 4gt, 5hp, 5go, 5ct, 5gf, 5ef, 5bz, 9al, 4de, 3nf. Philippine Islands: 1hr, 1cw, nuqg. Brazil: 1ab, 1ac, 2sp. Japan: 1aa. Mexico: 1b, 1k, 1aa, xda, 9a, 1x, 1j. England: 2nm, 2sz, 2od, 2iz, 2cc, 5lf, 6tm, 2wj. France: 8ee, 8tm, 8tok, 8bf, 8tk, 8wag. Porto Rico: 4sa, 4rl. Italy: 1au, 1gw. Argentina: aa8, cb8, dh5, fc6, ga2, fb5, ff9, bg8. Chile: 9tc, 2rm, 1gw, 2ld. Hawaii: 6buc, 6ajl, 6tz, 6aff, 6cst, 6asr, 6dbl, fxi. Bermuda: ber. Misc.: ane, vmg, nkf, nisp, ks, ab, nqg2, wvz, wqo, fw, wiz, npm, npu, npp, f8z, nve, nisir, kfuh. Qrn been vy bad this month. Glad qsl card confirming any of above. No qra's hr.

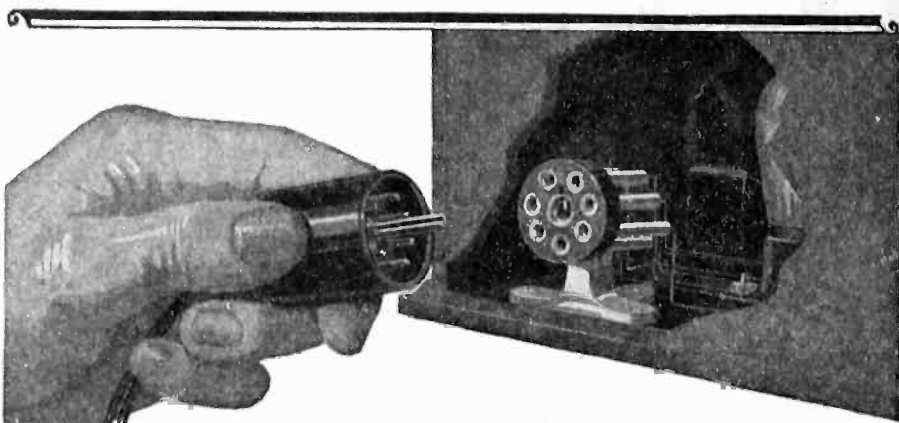

Affording a plug and socket connection between the radio set and all outside connections, Jones Multi-Plug is as essential to the radio as a cord and socket to the electric iron. For safety and convenience, leading set manufacturers have adopted this item as standard equipment. You, too, need a Multi-Plug for the set you are building or the set you now have. See your dealer or write direct for descriptive folder A.

Type BM-For set building \$4.50
Type BP-Adaptable to any set \$5.00

Howard B. Jones Chicago, Ill.

614 South Canal Street

Western Representatives:

A. S. LINDSTROM COMPANY

San Francisco Los Angeles Portland Seattle Salt Lake City

JACK L. HURSCH, Denver, Colo.



Jones MULTI-PLUG

THE STANDARD SET CONNECTOR

**VEBY
HIGH-MU
TUBES**
for
**Resistance
Coupled
Amplifiers**

For more power of better quality there is no equal to the VEBY TUBES for Resistance Coupled Amplifiers. Be sure they are VEBY for your own satisfaction.

A. F. 20 HIGH-MU\$3.50
A. F. 6 POWER TUBE for the last stage 4.50

Veby Radio Corporation
"Quality Resistors"
47-51 Morris Ave. Newark, N. J.



The TOWN CRIER
Radio's Most Beautiful Speaker

Send for illustrated description, in colors, of the Green and Golden Polychrome Models.
Ask Your Dealer to Show You a Town Crier.

\$17.50 List Price
\$18.50 West of the Rockies

Representative: S. A. WINSOR
1221 Venice Boulevard Los Angeles, Calif.
GALE RADIO LABORATORIES
2511 Irving Park Boulevard CHICAGO

RADIOCAST WEEKLY

Sixty-four Pages of Programs, Photos, Humor, Musical Reviews, Schedules, Tables, Editorials, Etc.

5c Per Radiocast Weekly
Copy 433 Pacific Bldg.,
SAN FRANCISCO

LABORATORY SERVICE

By G. M. BEST

"RADIO'S" New Calibration Laboratory Is Second to None

THE complete laboratory of the Pacific Radio Publishing Company is at your service. We make tests—calculations—give you expert advice on your radio problems. Gerald M. Best is in charge of our own laboratory. We have an assortment of the finest testing equipment available.

Use this service. Let us answer your radio questions for you. We give you expert advice on your radio problems. Our service is most accurate—entirely dependable and PROMPT.

We will answer ten of your radio questions if you subscribe to "RADIO" for only one year. With your subscription to "RADIO" you will receive ten coupons, entitling you to answers to ten radio questions.

The regular cost for answering ten questions is \$2.50. Save this money! Subscribe to "RADIO" and get your answers without cost.

Use the coupon. Attach your remittance of \$2.50 to it and mail now. Your investment of \$2.50 will pay big dividends. The coming issues of "RADIO" will surprise you.

This offer will shortly be withdrawn

Now is the time to act!

COUPON

"RADIO," Pacific Building, San Francisco, Calif.

Here is \$2.50. Send me "RADIO" for one year and 10 free coupons entitling me to answers to ten radio questions.

Name.....

Address.....

City and State.....

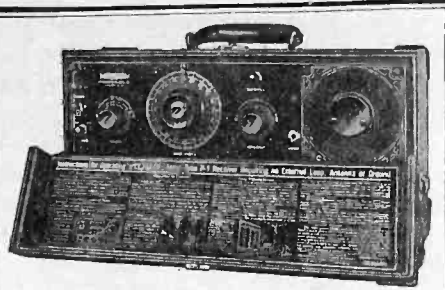

The Famous Truly Portable TELMACO P-1 Receiver

Four Tubes Do the Work of Seven

The peer of portables in size, weight, ease of tuning, selectivity, distance, volume, workmanship and price. Aerial, loud speaker and batteries self contained. Complete with tubes and batteries. **\$125.00**
\$141.50 Receiver only

P-1 Kit Saves You Money!

Our offer of the Telmaco P-1 Receiver in kit form has met with enthusiastic reception. This contains all parts, as built by us, including case, drilled and engraved panel, and illustrated instructions. **\$80.00**
Complete kit
Ask your dealer or write us. Descriptive folder free.

Radio Division:

Telephone Maintenance Co.
20 So. Wells St. Dept. A Chicago, Ill.



Quality Radio Exclusively Established 1918

ARE YOU A SUBSCRIBER?

Send for Trial Subscription
\$1.00 for Six Months

CLARITY



RATIOS 3 1/2 to 1—5 to 1

No set is better than its parts and no one part is more important than the Audio Transformer. That's why you should insist upon Supertrans in your set—they are by test, the best transformers on the market.

Distributed by

L. W. Cleveland Co., Portland, Me.
E. P. Denham, Seattle, Washington
Waite Auto Supply Co., Providence, R. I.
Gray Sales Co., Philadelphia, Pa.
Rice-Hitt Co., San Francisco, Calif.
A. B. Darmstadter, Chicago, Ill.
Whiting Radio Co., Bridgeport, Conn.
Paterson Radio Co., Paterson, N. J.
Buffalo Radiophone Co. Inc., Buffalo, N. Y.
The Jack L. Hirsch Co., Denver, Colo.

FORD RADIO & MICA CORP.
111-113 Bleecker St., N. Y.



REGISTERED U.S. PATENT OFFICE

AUDIO TRANSFORMER

Here's Work That is Almost ROMANCE!



Many EARN \$50. to \$250. a Week in RADIO

Get into the great new BIG-Pay Industry—Radio. If you're earning a penny less than \$50 a week, **clip coupon now.** Send for AMAZING FREE Book. Be a Radio Expert, and draw down big money for the easiest and most fascinating work in the world. Positions everywhere. Need for Radio Experts in every community. Short hours. **BIG PAY.** Free book gives all the facts.

LEARN QUICKLY AND EASILY AT HOME

Master Radio Engineers show you how to qualify, quickly and easily at home, for Radio's fine jobs. We guarantee to train you successfully. Every day N. R. I.-trained men are taking good places in the Radio field. Thousands of openings now awaiting the trained man. **FREE EMPLOYMENT SERVICE.** Many other big features. Get the facts—**CLIP COUPON.**



"My charges for consultation \$2.50 per hour. All success due to you." R. W. Blackhill, Brooklyn.

GET THIS FREE BOOK!

Send coupon for **FREE BOOK**—"Rich Rewards in Radio." Read for yourself. No previous experience needed. Common schooling enough.

WRITE NOW.



You get all these sets

Receiving sets, from simplest kind to thousand mile receiver, included to help you learn. **AN UNEQUALLED OFFER.** Other special features for limited time only—so **ACT QUICK!**

NATIONAL RADIO INSTITUTE
Dept. AV9, Washington, D. C.

MAIL COUPON

NATIONAL RADIO INSTITUTE,
Dept. AV9, Washington, D. C.

Without obligating me in any way, please send me your free book, "Rich Rewards in Radio," also complete information on your practical, home-study Radio course.

Name.....

Address.....

Town..... State.....

Hoyt

"SUPER" CONTROL METER



For instant attachment to the Radiola Super-heterodynes No. 25 and No. 28. A precision type moving coil voltmeter, with bronze rim, rubbed mahogany case and cloth-covered base, complete with cord. The scale of the meter is marked in red at 3 volts.

With this meter users of these sets will always secure the exact filament voltage for clearest reception and longest life of the tubes.

Price \$8.50

BURTON-ROGERS CO.
26 Brighton Ave., Boston, Mass.

RADIOCAST WEEKLY

Sixty-four Pages of Programs, Photos, Humor, Musical Reviews, Schedules, Tables, Editorials, Etc.

5c Per Radiocast Weekly
Copy 433 Pacific Bldg.,
SAN FRANCISCO

How to Get the Most Out of Your Set

514 PAGES ONLY \$1

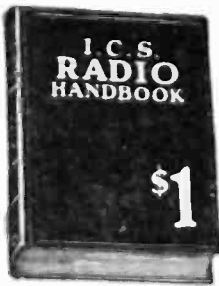

Compiled by **HARRY F. DART, E.E.**
Formerly with the Western Electric Co., and U. S. Army Instructor of Radio. Technically edited by F. H. Doane.

The I. C. S. Radio Handbook will help you to get more enjoyment out of radio. It clears up the mysteries—tells you just what you want to know. Written by nationally known radio authorities in language that you can understand. An absolute necessity for every radio fan. A wonderful bargain at \$1. Note this partial list of contents—Electrical terms and circuits, antennas, batteries, generators and motors, electron (vacuum tubes), many receiving book-ups, radio and audio frequency amplification, broadcast and commercial transmitters and receivers, super-regeneration, licenses, etc.

Send \$1 today and get this 514-page I. C. S. Radio Handbook—the biggest value in radio today

International Correspondence Schools
Box 8263-D, Scranton, Penna.

I enclose One Dollar. Please send me—post-paid—the 514-page I. C. S. Radio Handbook. It is understood that if I am not entirely satisfied I may return this book within five days and you will refund my money.

Name _____

Address _____

Check here and enclose \$1.50 if you wish the edition bound in Leatheroid

REFLEX CIRCUIT ASSEMBLY (Continued from Page 29)

shunt the primary of an a. f. transformer or the headphones.

Crowded apparatus is often the cause of unsatisfactory results. Crowding was sometimes necessary to secure short r. f. leads, but with an r. f. choke coil this

heavy wiring of Fig. 1C, will improve the neatness and appearance of the set. Wiring looks best when there is little of it.

Many of these suggestions are incorporated in the layout shown in Fig. 4, in accordance with the circuit diagram of Fig. 3. This is a three-tube inverse

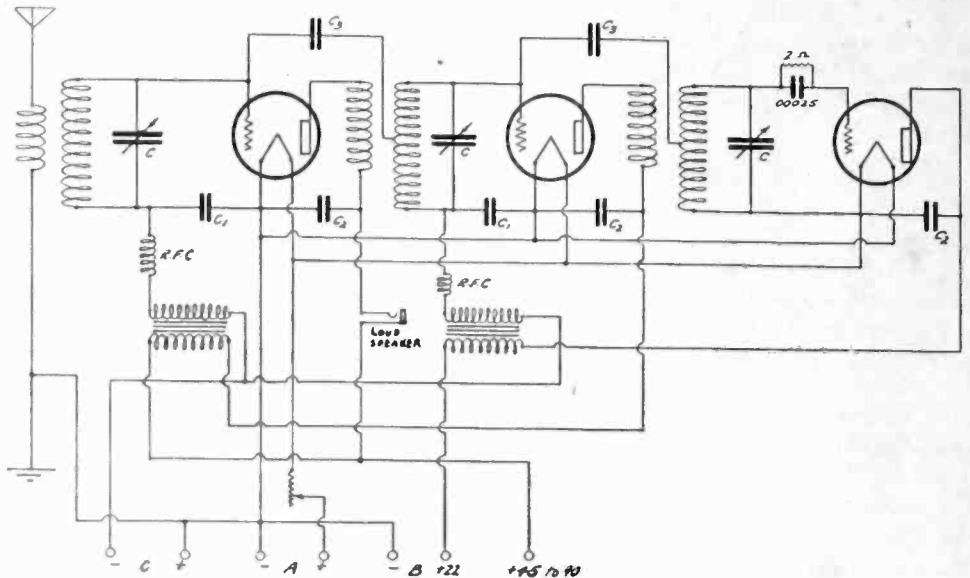

Fig. 3. Circuit Diagram for Three Tube Inverse Duplex.

no longer necessary. The r. f. transformer and choke should be placed so that the fields will not cut in on transformers and other metal parts, including the metal of the wiring. Interstage coupling between r. f. coils is reduced by placing them far apart and setting them at such an angle as will minimize coupling. This precaution even applies to toroidal coils. It will also be found that untuned r. f. transformers are not effective amplifiers.

Bunching all wires that have been bypassed by fixed condensers, such as the

duplex, giving two stages of tuned r. f., non-regenerative detector and two stages of audio. C_1 is a .0002 mfd. condenser, C_2 a .0025 mfd., and C_3 is a neutralizing condenser. P consists of 20 turns of No. 30 D. S. C. at the secondary filament end and S of 60 turns of No. 22 d. s. c. wound so as to give a coil $3\frac{1}{2}$ in. in diameter and tapped 18 turns from the filament end for neutralization. C is a .00035 mfd. variable condenser. The r. f. chokes are similar to those already described.

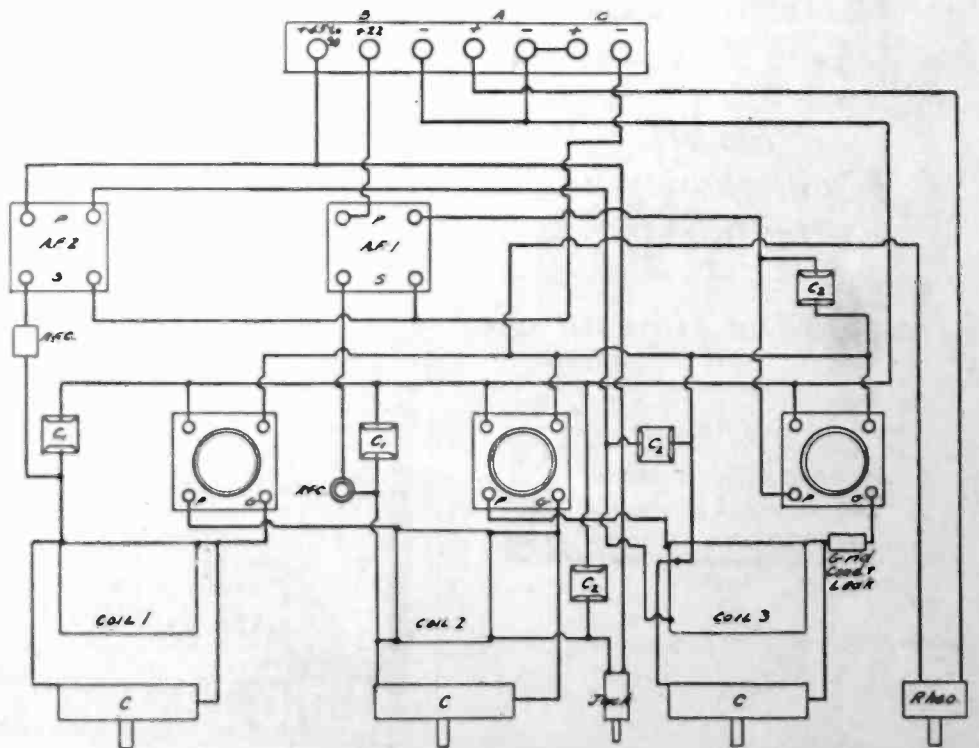

Fig. 4. Pictorial Wiring Diagram for Three Tube Inverse Duplex.

HANDY HINTS

The best glue for general use in the wood-working shop where joints and veneers are being made is that known as animal glue, coming from hides, hoofs, horns and bones of cattle. It comes in dry form and must be mixed with water and melted before it is applied warm with a brush or mechanical spreader. The best grade is stronger than any American wood with which it might be used nor does it stain the wood. It is not good for articles to be placed in water.

If water resistance is important, casein glue should be used. This is mixed and applied cold. It is likely to stain some thin veneers and is not as strong as animal glue. Its cost is about the same, varying from 12 to 30 cents a pound.

The cheapest glue is the vegetable glue made from starch. It is used mainly for veneer work, not having the strength nor the rapid setting of the others. It can be used cold and does not readily decompose upon standing. It has low water resistance.

The liquid glues made from fish refuse come in prepared form ready for immediate use. Some brands are almost as strong as animal glues but other brands are weak and unreliable. They are non-resistant to water and usually cost more than the others.

Another more expensive kind, having high water resistance is glue made from soluble blood albumin. It is especially water-resistant and does not stain.

**The Five Tube
Set which
startled
the World!**

**FRESHMAN
MASTERPIECE**

**The Greatest Value
Ever Offered in A
Radio Receiving Set**

At Authorized Dealers

ARE YOU A SUBSCRIBER?
SEND FOR TRIAL SUBSCRIPTION
\$1.00 FOR SIX MONTHS

RADIOADS

A Classified Advertising Section Read by Better Buyers

The rate per word is eight cents net. Remittance must accompany all advertisements.
Include name and address when counting words.

ADS FOR THE FEBRUARY ISSUE MUST REACH US BY JANUARY FIFTH

SUPERSENSITIVE GALENA CRYSTALS, pound, \$1.00, prepaid. **ALKEMITE All-sensitive Crystals**, 50c. Buskett, Metallurgist, Joplin, Mo. (T.C.)

AGENTS WANTED TO ADVERTISE our goods and distribute free samples to consumers; 90c an hour; write for full particulars. **AMERICAN PRODUCTS CO.**, 4199 American Bldg., Avarath, Ohio.

WANTED—More readers of "RADIO" to advertise their used equipment in these columns. **RADIOADS** bring quick and profitable sales. Turn your excess apparatus into profit. Some of our readers want just what you have to offer. Try the **RADIOADS**. You, too, will then be convinced that they **PAY**. Mail your copy now for the next issue.

"**RADIOCAST WEEKLY**," published by the publishers of "RADIO." Gives you reliable and accurate daily schedules and programs of all the big Pacific Coast stations. Also a number of feature articles every week. Send five cents for a trial copy. \$1.00 brings the magazine to your home every week for 26 weeks. Once you read it, you will never be without it. "**RADIOCAST WEEKLY**," 433 Pacific Bldg., San Francisco.

MEN wishing to enter dining, sleeping car service as conductors, porters, waiters, write 123 Railway Exchange, Kansas City.

MAKE \$100 WEEKLY in spare time. Sell what the public wants—long distance radio receiving sets. Two sales weekly pays \$100 profit. No big investment, no canvassing. Sharpe of Colorado made \$955 in one month. Representatives wanted at once. This plan is sweeping the country. Write today before your county is gone. **OZARKA, INC.**, 126-E Austin Avenue, Chicago.

FUNNY RADIO STORIES. Twelve of 'em in the "**RADIOBUSTER**," Volney G. Mathison's humorous thriller. 112 pages in bound form. Mathison knows how to write. You will enjoy his stories. Send \$1.00 today for a copy of the "**RADIOBUSTER**," or get it free with your subscription to "**RADIO**" for one year (\$2.50). Pacific Radio Publishing Co., Pacific Building, San Francisco.

YOUR RADIO QUESTIONS ANSWERED FREE.—Gerald M. Best, technical editor of "RADIO," will answer ten radio questions for you if you subscribe to "RADIO" for only one year at \$2.50. Get this wonderful technical service, together with a good, practical radio magazine. "RADIO," Pacific Bldg., San Francisco.

AGENTS—90c an hour to advertise and distribute samples to consumer. Write quick for territory and particulars. **AMERICAN PRODUCTS CO.**, 4200 American Bldg., Cincinnati, Ohio.

GEARS AND MODEL SUPPLIES of every description. Catalog 5 cents. Experimenters' Supply House, Box 10, Station Y, New York City.

PHONOGRAPH UNITS FREE. The new union Fabric Unit with soft rubber attachment. One subscription to "RADIO" for one year at \$2.50 brings you the unit as a premium. Get one now. Only a few on hand. "RADIO," Pacific Building, San Francisco.

KEEP station records in **THE RADIO LOG BOOK**, a handy pamphlet for recording stations heard, dial settings and other data. The price is only 10 cents per copy. For sale by Pacific Radio Pub. Co., Pacific Building, San Francisco.

SELL—1 ElKay 4 tube receiver, real distance getter, \$79.00. 1 three tube regenerative set, \$34.00. Edison elements for B Batteries, 4 cents per pair. L. Giannini, 561 Brussels Street, San Francisco, Cal.

BUILD your own Edison lifetime "B" Battery from largest size, clean Edison elements, wired with pure nickel wire, electrically welded connections. Sample cell and "dope" sheet 10 cents. Wired elements 7c pair; glass cells, 3½c each; dry electrolyte, 50c pound (enough for 80 volts.) All parts in stock. Quick service. Chas. Snively, 7UV, Woodburn, Ore.

AGENTS—100% profit; wonderful little article. Something new; sells like wildfire. Carry in pocket. Write at once for free sample offer. **ALBERT MILLS, MANAGER**, 5791 AMERICAN BLDG., CINCINNATI, OHIO.

A-C-B POWER UNITS AND PARTS have been manufactured by us for fifteen months and operating neutro-dyne sets without batteries. Prices reasonable. Patents applied for. Gardner Electric Mfg. Co., Emeryville, Calif.

LAST STAGE NOISY? Substitute a **NORMA** transformer. Norma Gardner, 4424 View St., Oakland, Calif.

SELL Nationally Advertised Radio Sets in spare time. Three sales weekly pay \$90.00 profit. Write for wholesale prices. **DIRECT RADIO CO.**, 197B Fourteenth St., Milwaukee, Wis.

THE NEW square plate Ensign Variable Condensers. **JUST OUT!** Brass plates. Efficient on low waves. Get one of these condensers without cost in return for your subscription to "RADIO" for only two years. Five dollars brings you the condenser and the magazine. Send your check now. There are only a few of these condensers in our stock. "RADIO," Pacific Building, San Francisco.

TWO FOR THE PRICE OF ONE

In order to introduce our weekly publication, "**RADIOCAST WEEKLY**," to readers of "RADIO," we offer you a subscription to both magazines for the price of one. Simply send us \$2.50, the regular subscription price for "RADIO," and you get **BOTH** magazines for a full year—52 issues of "**RADIOCAST WEEKLY**" and 12 is-

ues of "RADIO." "**RADIOCAST WEEKLY**" is a 64-page magazine containing programs of local and DX stations as well as reliable daily schedules and operating data. It is a very valuable publication. One copy will convince you. Subscribe now and save almost half.

PACIFIC RADIO PUB. CO., Pacific Bldg., S. F.



6-VOLT "A" BATTERY
Here is the rugged, good-looking Exide 6-volt "A" Battery. One-piece case.



2-VOLT "A" BATTERY
Compact Exide for low-voltage tubes. Also made in 4-volt size.



24-VOLT "B" BATTERY
In glass cells, 6000 milliamperes hour capacity. Also in 48-volt size.



RECTIFIER
Exide Rectifier for economical recharging of "B" Battery from your own house current.

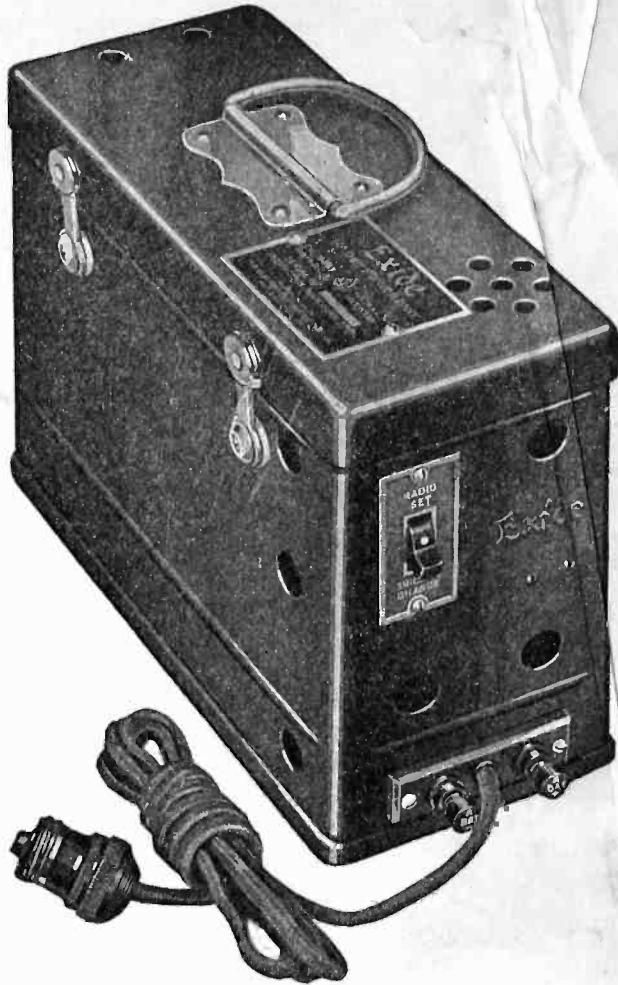

THE EXIDE RADIO POWER UNIT
(Combination "A" battery and charger)

This unit is kept connected to your electric light socket as well as to the radio set. Raise the small switch on the end and the receiving set is ready for use; lower it and the battery is automatically placed on charge. Finished in rich mahogany color, the Exide Radio Power Unit is furnished in two sizes — one, for sets using 4-volt tubes; the other for sets using 6-volt tubes; retailing at \$28 and \$38 respectively — slightly higher west of the Rockies.

Range far and near with your radio set

BRINGING in the distant stations, selecting the choice numbers from local programs—in short, getting the most enjoyment from your radio set—is largely a matter of proper current supply.

All the distance, volume, and clearness that an ample, uniform supply of current gives to radio reception are yours when current is supplied by Exide Radio Batteries. There are Exide "A" and "B" storage batteries for every requirement, and a rectifier for recharging "B" storage batteries.

See the complete line at any Exide Dealer's or at your favorite radio store.

Exide
RADIO
BATTERIES

THE ELECTRIC STORAGE BATTERY COMPANY, Philadelphia
Exide Batteries of Canada, Limited, 153 Dufferin Street, Toronto

FOR BETTER RADIO RECEPTION, USE STORAGE BATTERIES

Tell them that you saw it in RADIO